



PRODUCT: JT Gladiator Tall Riser Bed Rack System

REV: B | 01-03-2022 | R77400

READ INSTRUCTIONS IN FULL BEFORE INSTALLATION.
QUESTIONS? CALL 916-760-4575 M-F 7:00 AM – 5:00 PM PST

The ARS experience includes the ease of installation of our products. We design for most contingencies, but installation may be different based on different Jeep condition, configuration and/or year.

We are continually trying to improve our products and instructions – please help us by providing feedback and pictures if you find any part of the instructions that do not match your Jeep or are not easily understandable.

If you have any difficulties at all, please give us a call. Thank you and enjoy your ARS Products!

IMPORTANT NOTE: We use Stainless Steel Hardware where possible. Therefore, a tube of Silver Anti-seize is provided and should be used on all bolts—only a small amount is needed.

WARRANTY INFORMATION: This article is sold without warranty expressed or implied. No warranty or representation is made as to this products ability to protect the user from injury or death. The user assumes that risk. The effectiveness, warranty and longevity of this equipment are directly related to the way it is INSTALLED, USED and/or MAINTAINED. THE USER ASSUMES ALL RISK. By purchasing this product and opening the packaging, purchasers expressly acknowledge, understand and agree that they take, select and purchase these ARS products from Armored Works, LLC, its affiliates and distributors and agents as is and with all faults. The entire risk as to the quality and performance of these ARS products is with the purchaser. Working on your vehicle can be a dangerous activity. If you are unsure of what you are doing, please leave mechanical or safety critical work to a skilled mechanic. We take no responsibility for the incorrect use and/or installation of ARS products.

Section 1: Tools & Notes on Installation



Tools Required: This list is the recommended tools for ease of installation. Other versions of the same tool can be used. For example, Allen Wrenches instead of Allen Drive Sockets.



Socket Wrench

7/32" Allen Wrench
3/8" Allen Wrench



1/2" Socket or Wrench

HOW TO USE THIS GUIDE: The installation guide contains ALL steps for installation. Please read and follow the instructions in order of each page top to bottom and left to right.

Jeep Model: Instructions may apply to multiple Jeep models but are labeled separately where appropriate (i.e. TJ vs. LJ).

Options: Because of the number of component options we offer, these instructions may contain steps that will not match your configuration. You can skip these steps.

Images: Pictures are provided, and parts are labeled throughout the instructions. Each text box contains guidance based on the pictures next to it. The text will refer to alphabetical labels (A, B, etc.) found in the images.

Installation Notes: Terms may be used in the body of the instructions that you may not be familiar with, if you have any questions feel free to contact us at the number below, or email techhelp@metalcloak.com

QUESTIONS: Any questions or comments about the instructions? Call us at 916-760-4575 M-F 7:00 AM – 5:00 PM PST.

Section 2: Product Components

DC-0001 Rev B

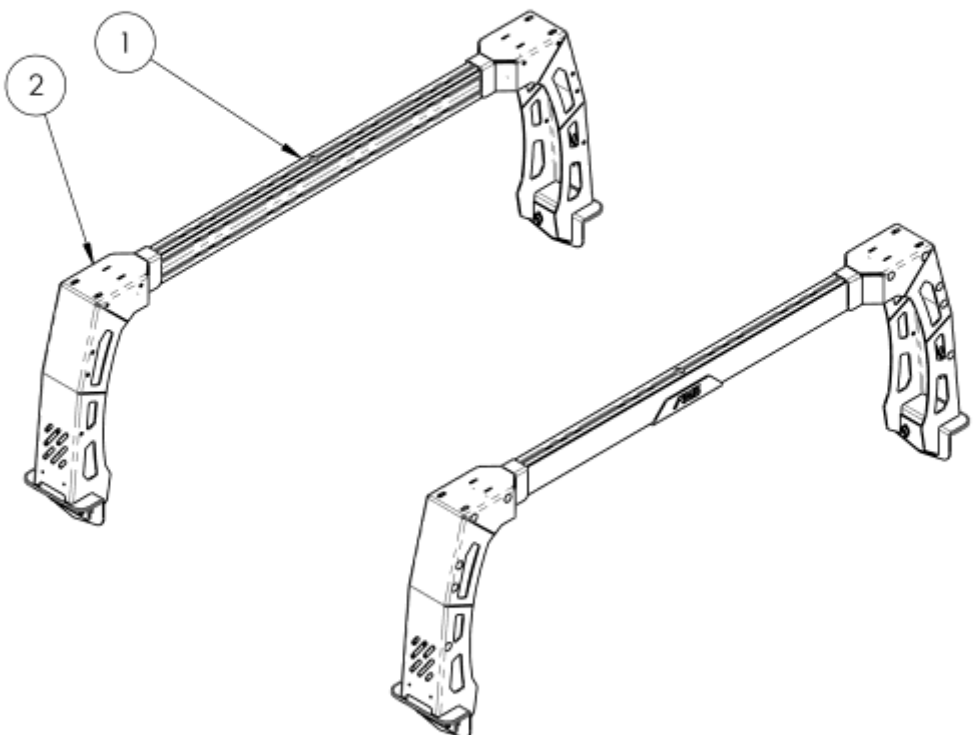
1	2	3	4	5	6	7	8
ITEM	PART NUMBER/DESCRIPTION			QTY.			
1	R77001 ARS BED RACK CROSS BEAMS, 50IN			1			
2	R77300 TALL RISER BED RACK, 19IN			1			
<p>E</p> <p>OPTIONS:</p> <ol style="list-style-type: none"> 1. R77100 BED RACK MIDDLE SUPPORT KIT, JT 2. R77200 BED RACK SIDE ACCESSORY PNL, JT 3. R77600 TALL BED RACK SIDE ACCESSORY PNL KIT, JT 							
							
				<p>D</p> <p>C</p> <p>B</p> <p>A</p>			
				<p>THE INFORMATION CONTAINED ON THIS DRAWING IS THE EXCLUSIVE PROPERTY OF ARMORED WORKS, LLC. UNAUTHORIZED REPRODUCTION IS PROHIBITED. DO NOT SCALE DRAWING</p>			
				<p>Metal Cloak <small>A DIVISION OF ARMORED WORKS, LLC</small></p>			
				<p>PART NUMBER/DESCRIPTION R77400 ARS TALL RISER BED RACK SYSTEM 19IN</p>			



Section 3: Installation Instructions

Step 1: Preparation for Rack Installation

Important Note: *These instructions are for the Tall Risers Base Rack only. If you have the Tall Riser with additional accessories like the Middle Support Kit, Accessory Side Panels, or Roof Top Tent Brackets check out the Tall Riser Bed Rack System instructions at modernjeepforum.com to help prevent repeating steps.*

- A. Loosen the plastic nut on the tie down and slide the tie downs to the end of the gear track to remove.
- B. Place two of the gold zinc gear track mounting brackets inside the gear track on each side of the bed.
- C. Measure the bed width.

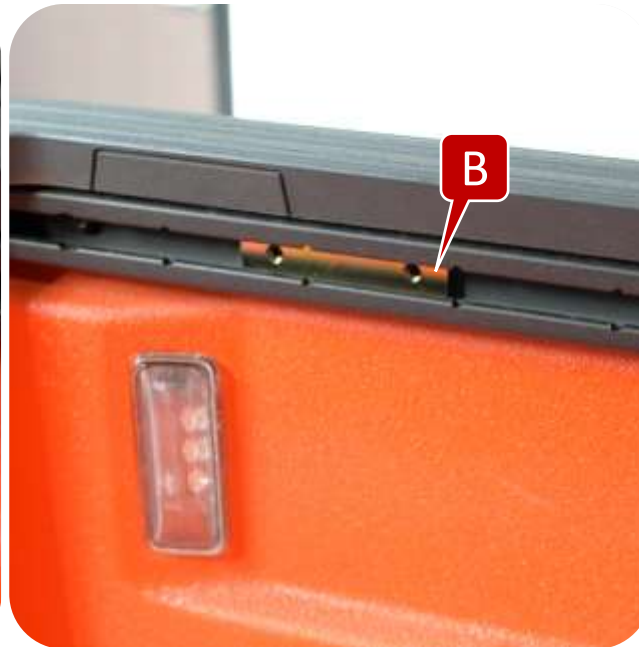

Section 3: Installation Instructions



Step 2: Tall Riser Rack Assembly

- D. Press the ARS bed riser pad into the bed riser legs. Use a mallet if needed.
- E. Prepare the riser bed legs by loosely installing two carriage bolts, washers, split washer, and nut into each leg. Place bolts in mirrored locations of each leg in sets of two.



Section 3: Installation Instructions



Step 2: Mid Riser Rack Assembly

Important Note: Depending on what options you have selected will indicate how many carriage bolts and slot nuts you will install into the bed riser extrusion bars. If you purchased the Middle Support Kit you will need to put two slot nuts in each of the bed riser extrusions (upper and lower extrusions). If you purchased the Roof Top Tent Bed Rack Adapter Kit you will need to add four carriage bolts into the upper extrusion of the bed riser extrusion bar. If you have both options, you will need to put two slot nuts into each of the bed riser extrusions (upper and lower extrusions) and four carriage bolts in the upper extrusion (Install the slot nuts first).

- F. Slide slot nuts and carriage bolts into the bed riser extrusion bars based on the accessories you have (see important note for more information).
- G. Slide the extrusion bar into the legs setting the mounting distance at the bed width (56 3/16" is a starting point).

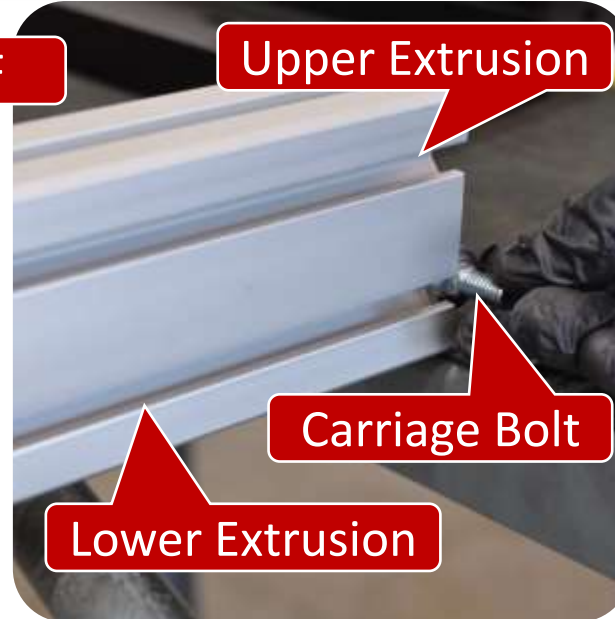
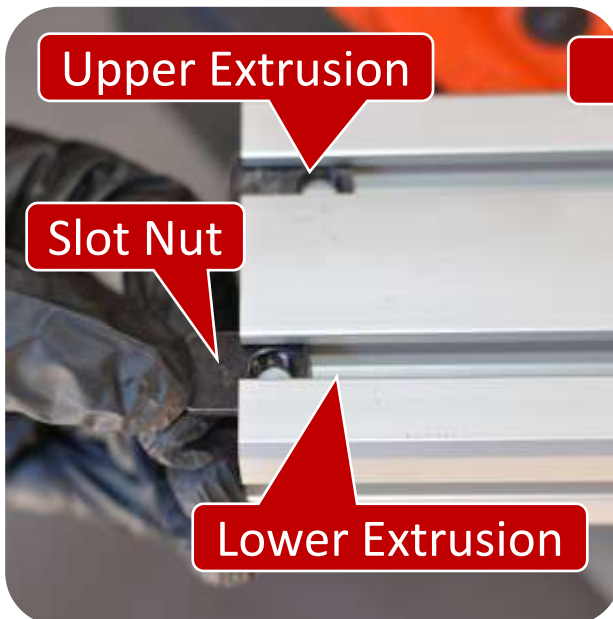

Section 3: Installation Instructions



Step 3: Tall Riser Rack Installation

- H. Place the bed risers in the bed with extrusion slots facing in toward each other.
- I. Bolt the bed risers to the gear track mounting bracket loosely.
- J. Using a 1/2" wrench tighten down the extrusion bars in the tower legs.

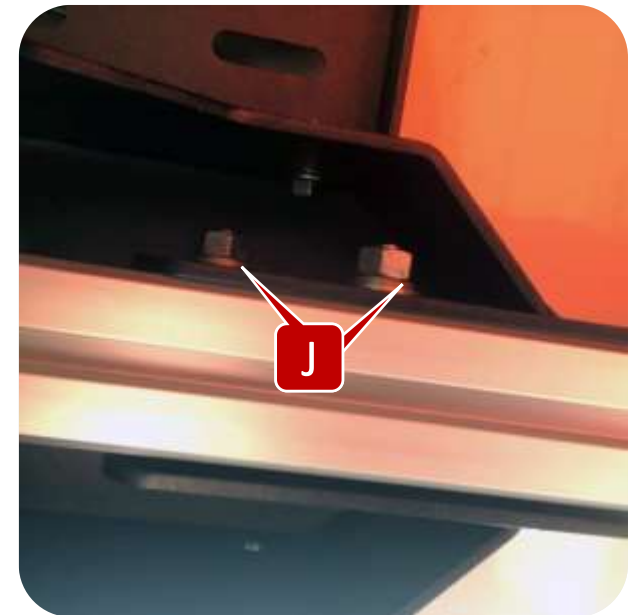

Section 3: Installation Instructions



Step 3: Tall Riser Rack Installation

- K. Slide two T-slot nuts into the bottom slot of the rear extrusion bar (*Tall riser closest to the tail gate*).
- L. Press the black plastic push rivets in visible outward holes in the bed riser legs.



Section 3: Installation Instructions



Important Note: *The following steps are for all of the riser accessories. Go to the page that correlates to the accessories you have:*

Middle Support Bracket: *Page 10*

Accessory Panels: *Page 14*

Tall Riser Accessory Panels: *Page 15*

Roof Top Tent Brackets: *Page 16*

Section 3: Installation Instructions



Step 4: Mid Support Assembly

- Using the provided hardware connect the bed rack middle support bracket ends to the middle accessory tray.
- Using a 1/2" Socket and wrench tighten the middle support bracket and accessory tray hardware.
- Install two T-slot nuts in the upper extrusion and T-slot nuts in the lower extrusion of the extrusion bars.

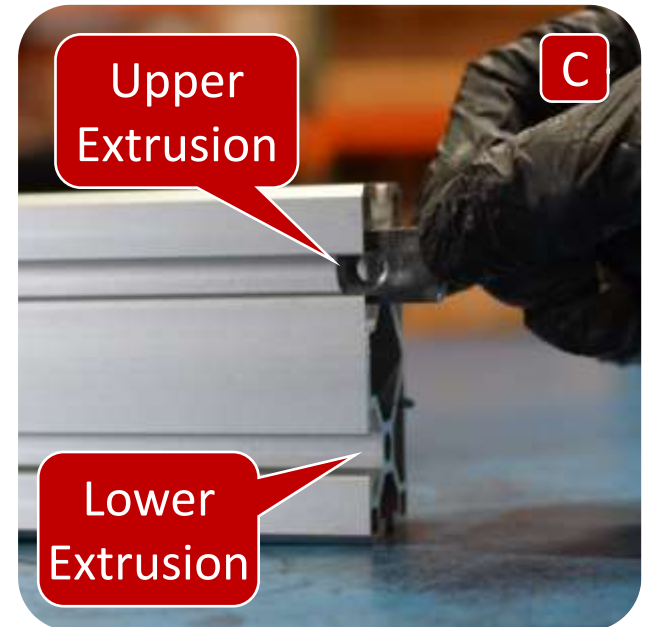
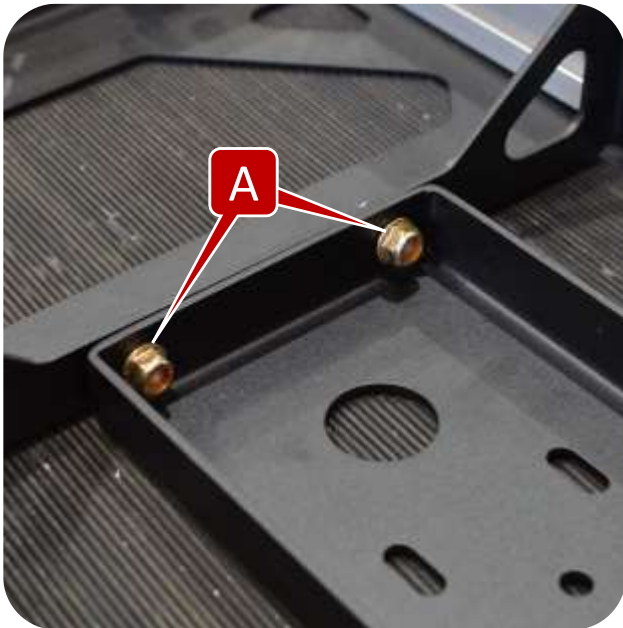
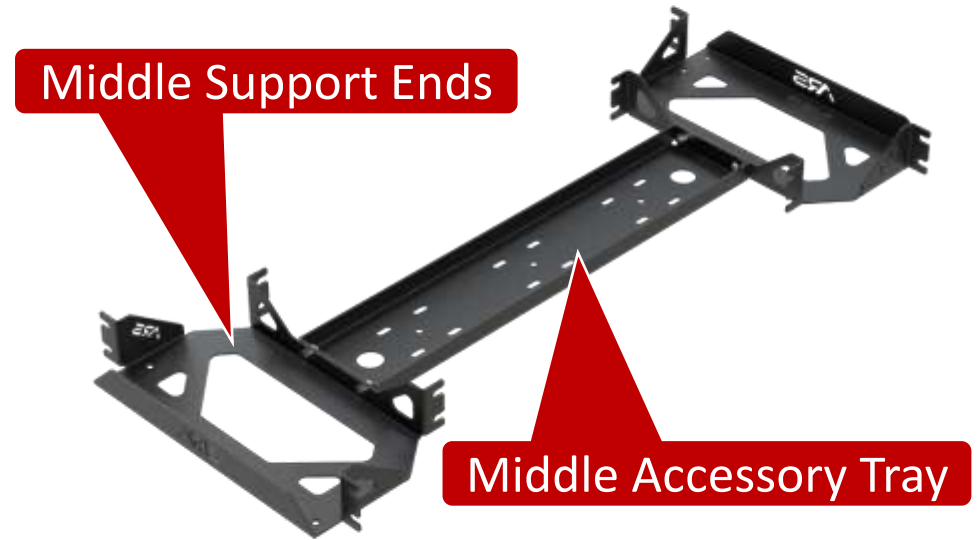

Section 3: Installation Instructions



Step 4: Mid Support Assembly

- D. Install two slot nuts into the extrusion on the underside of the mid support bracket extrusion bars.
- E. Attach the extrusion bars to the middle support bracket using the provided allen bolts and T-slot nuts.
- F. Using a 3/16" allen wrench tighten the extrusions to the middle support bracket.

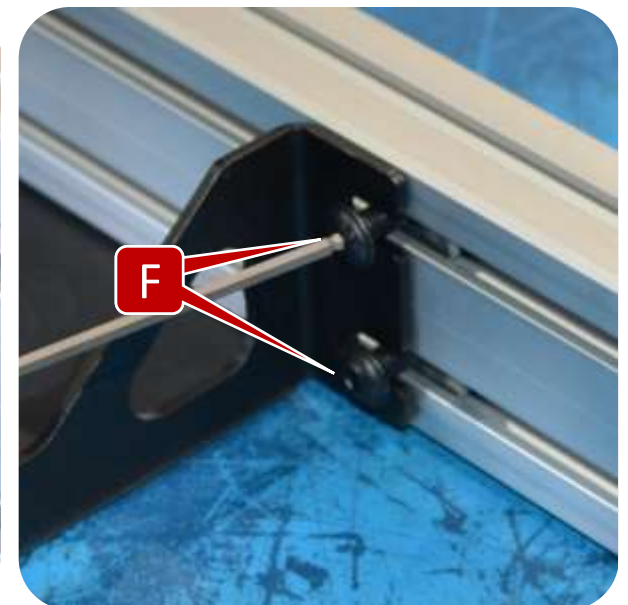
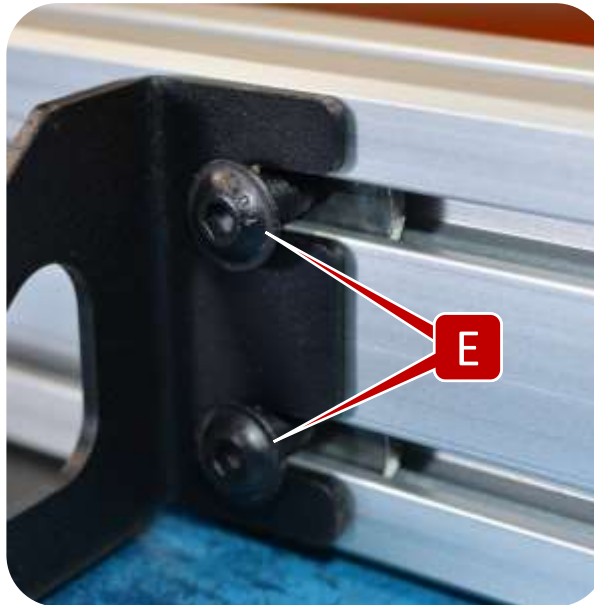
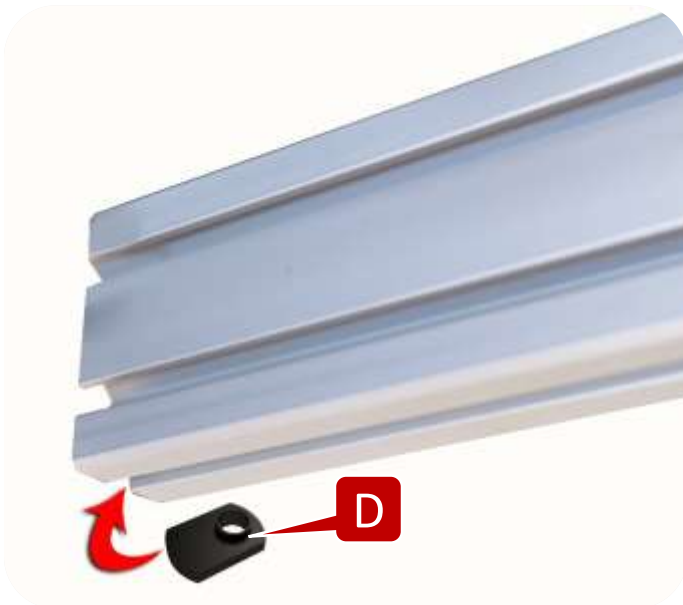

Section 3: Installation Instructions



Step 4: Mid Support Assembly

- G. Using a 3/16 allen wrench tighten the provided bolts into the slot nuts on the bottom of the middle support bracket extrusion bars.
- H. Mount the middle support assembly to the mid risers making sure it is centered between the risers.



Section 3: Installation Instructions



Step 5: Mid Support Installation

- I. Using the provided bolts connect the middle support bracket to the mid riser or tall riser extrusion bars slot nuts.
- J. Using the provided bolts connect the middle support bracket to the slot nuts on the underside of the riser extrusion bars.
- K. Using a 3/16" allen wrench tighten the middle support assembly bolts.
- L. Using a 3/16" allen wrench tighten the slot nut bolts on the underside of the riser extrusion bars.
- M. Tighten riser hardware using a 7/32" allen.

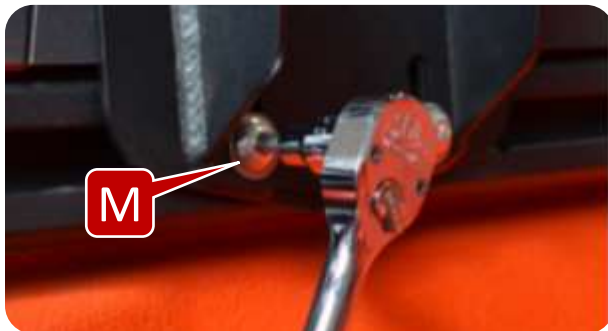
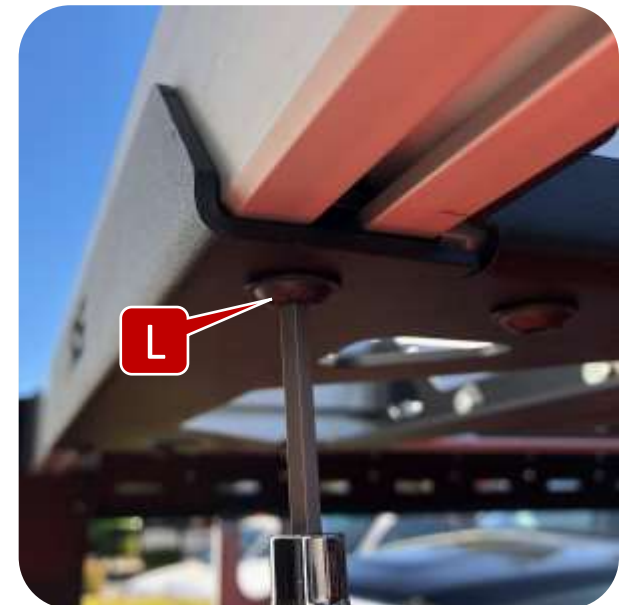

Section 3: Installation Instructions



Step 6: Install the Accessory Panels

- A. Place the accessory panel between the two bed riser legs making it flush with the top of the risers to align the holes.
- B. Using the provided bolts, washers, and nuts attach the accessory panel to the bed riser legs.
- C. Using a $3/8''$ and $7/32''$ wrench tighten the accessory panel hardware.
- D. Tighten riser hardware using a $7/32''$ allen.

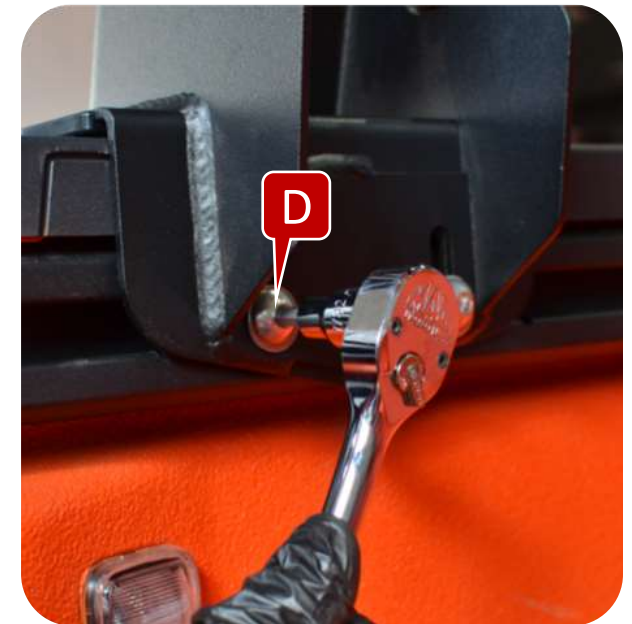
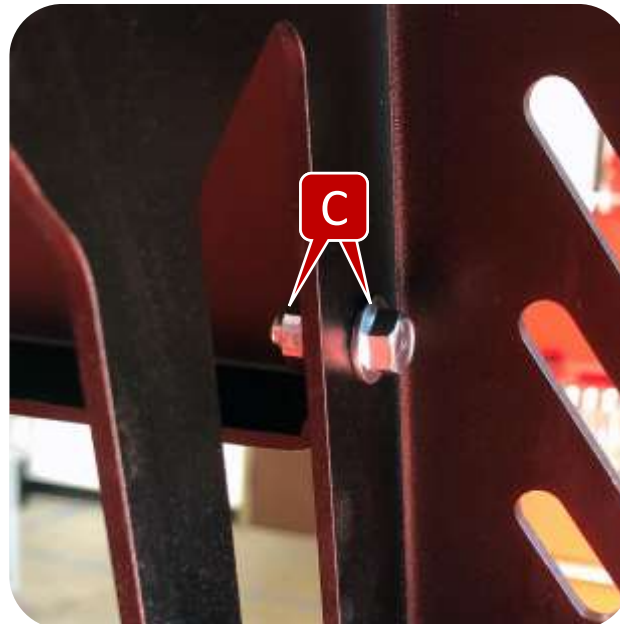



Section 3: Installation Instructions

Step 1: Install the Tall Riser Accessory Panels

- A. Place the accessory panel between the two bed riser legs making it flush with the top of the risers to align the holes.
- B. Using the provided bolts and nuts attach the accessory panel to the bed riser legs.
- C. Using a $3/8''$ and $7/32''$ wrench tighten the accessory panel hardware.

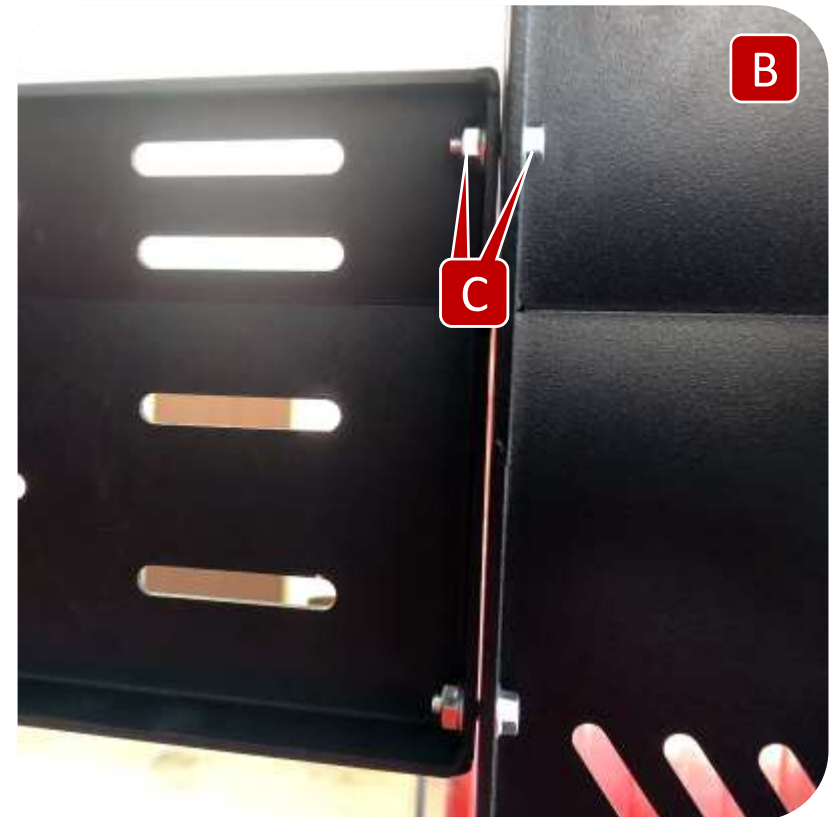

Section 3: Installation Instructions



Step 7: Install Roof Top Tent Brackets

- A. Install four carriage bolts into the top side extrusion on the mid riser or tall riser extrusion bar.
- B. Install the roof top tent brackets onto the carriage bolts.
- C. Install the provided washers, split washers, and nuts onto the carriage bolts.
- D. Tighten the risers with a 7/32" allen then place your roof top tent onto the rack and center.

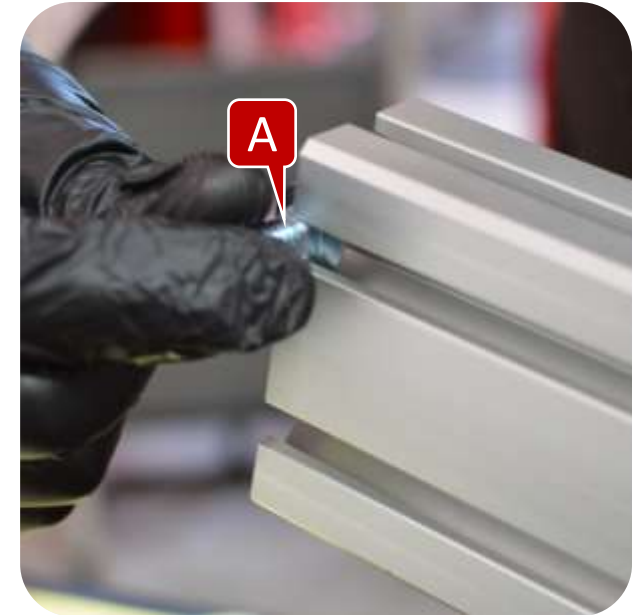

Important Note: ARS provides gold zinc threaded plates for roof top tents with larger extrusions (fits 1.25" or larger). If you have a roof top tent with smaller extrusions (less than 1.25") use the provided hardware supplied by the roof top tent.

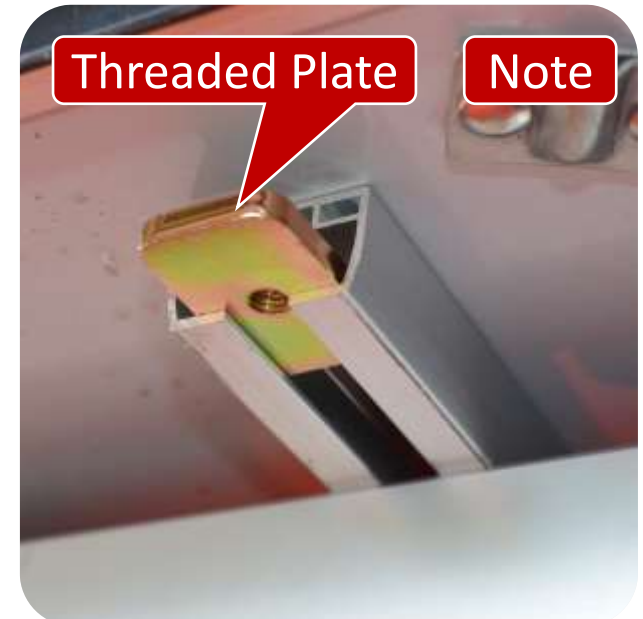
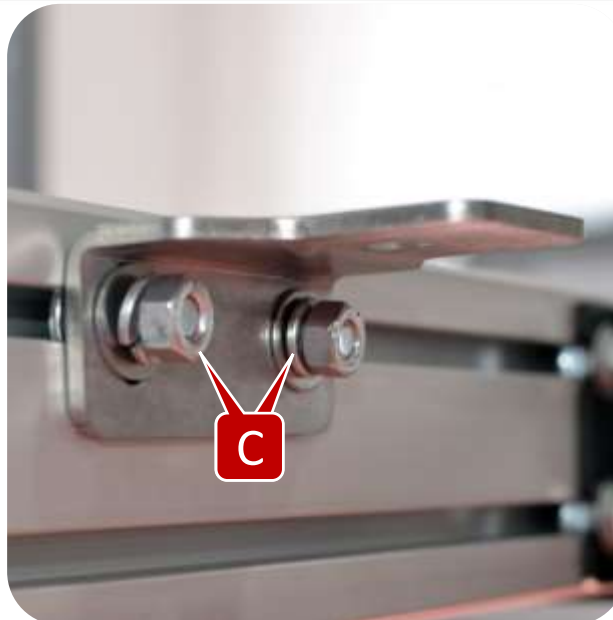

Section 3: Installation Instructions



Step 7: Install Roof Top Tent Brackets

- E. Align the roof top tent bracket to the tent rail and install the provided washers, split washers, and bolts into the provided gold zined threaded plate or stock roof top tent hardware.
- F. Using a 1/2" wrench tighten the carriage bolt hardware.
- G. Using a 7/32" allen wrench tighten the gold zinc threaded plate.

