



## PRODUCT: TJ/LJ Rear Brake Line 22L

REV: A | 04-12-2016 | II-1105

**READ INSTRUCTIONS IN FULL BEFORE INSTALLATION.**  
**QUESTIONS? CALL 916-631-8071 M-F 7:00 AM – 5:00 PM PST**

The MetalCloak experience includes the ease of installation of our products. We design for most contingencies, but installation may be different based on different Jeep condition, configuration and/or year.

We are continually trying to improve our products and instructions – please help us by providing feedback and pictures if you find any part of the instructions that do not match your particular Jeep or are not easily understandable.

If you have any difficulties at all, please give us a call. Thank you and enjoy your MetalCloak Products!

**IMPORTANT NOTE: We use Stainless Steel Hardware where possible. Therefore, a tube of Silver Anti-seize is provided and should be used on all bolts—only a small amount is needed.**

**WARRANTY INFORMATION:** This article is sold without warranty expressed or implied. No warranty or representation is made as to this products ability to protect the user from injury or death. The user assumes that risk. The effectiveness, warranty and longevity of this equipment are directly related to the manner in which it is INSTALLED, USED and/or MAINTAINED. THE USER ASSUMES ALL RISK. By purchasing this product and opening the packaging, purchasers expressly acknowledge, understand and agree that they take, select and purchase these MetalCloak products from Armored Works, LLC, its affiliates and distributors and agents as is and with all faults. The entire risk as to the quality and performance of these MetalCloak products is with the purchaser. Working on your vehicle can be a dangerous activity. If you are unsure of what you are doing, please leave mechanical or safety critical work to a skilled mechanic. We take no responsibility for the incorrect use and/or installation of MetalCloak products.

## Section 1: Tools & Notes on Installation



**Tools Required:** This list is the recommended tools for ease of installation. Other versions of the same tool can be used. For example, Allen Wrenches instead of Allen Drive Sockets.



14MM Box Wrench  
3/8IN Box or line Wrench

T-40 Socket



**HOW TO USE THIS GUIDE:** The installation guide contains ALL steps for installation. Please read and follow the instructions in order of each page top to bottom, and left to right.

**Jeep Model:** Instructions may apply to multiple Jeep models, but are labeled separately where appropriate (i.e. TJ vs. LJ).

**Options:** Because of the number of component options we offer, these instructions may contain steps that will not match your particular configuration. You can skip these steps.

**Images:** Pictures are provided and parts are labeled throughout the instructions. Each text box contains guidance based on the pictures next to it. The text will refer to alphabetical labels (A, B, etc.) found in the images.

**Installation Notes:** Terms may be used in the body of the instructions that you may not be familiar with, if you have any questions feel free to contact us at the number below, or email [techhelp@metalcloak.com](mailto:techhelp@metalcloak.com)

**QUESTIONS:** Any questions or comments about the instructions? Call us at 916-631-8071 M-F 7:00 AM – 5:00 PM PST.

## Section 2: Product Components

DC-0001 REV A

SHEET 1 OF 1

ITEM	PART NUMBER/DESCRIPTION	QTY.
1	FA-1106 BRAKE LINE RETAINING CLIP	1
2	FA-1108 BRACKET, BRAKE LINE, ZNC PLT STL	1
3	FS-05124 HHCS FLANGE SELF-TAP, 0.31-18 X 0.63L STL GF ZINC	1
4	SS-1109 BRAKE LINE, TJ REAR 25L	1

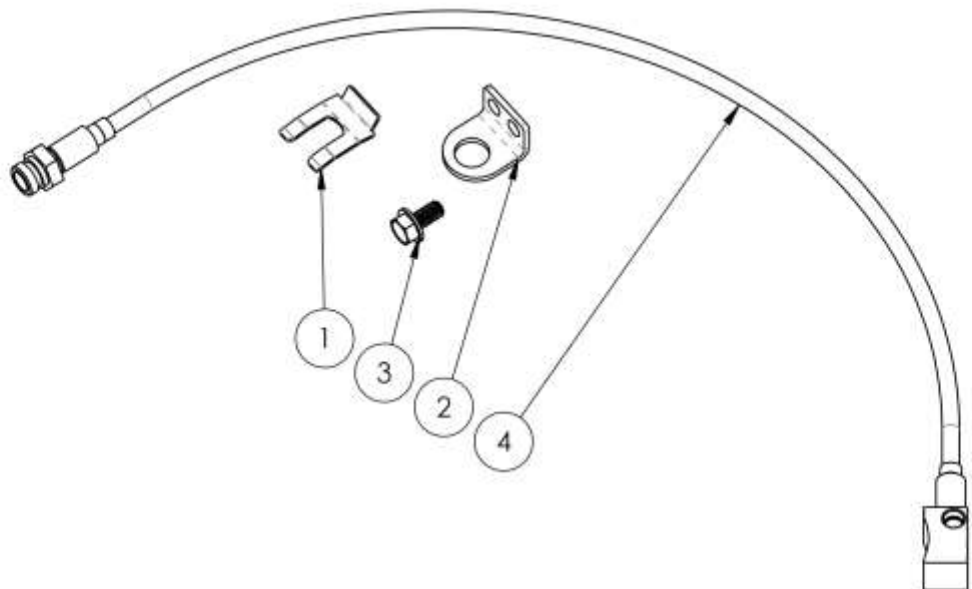
THE INFORMATION CONTAINED ON THIS DRAWING IS THE EXCLUSIVE PROPERTY OF ARMORED WORKS, LLC. UNAUTHORIZED REPRODUCTION IS PROHIBITED.  
**DO NOT SCALE DRAWING**

**METAL CLOAK**  
 A DIVISION OF ARMORED WORKS, LLC

**PART NUMBER/DESCRIPTION**  
 1109 BRAKE LINE KIT, TJ REAR 22L

## Section 3: Installation Instructions

### Step 1: Install Brake Line at the Frame

- A. Start by loosening the hard line from the soft line with a 3/8" line wrench or a open end wrench.
- B. Remove the soft brake line from the frame using a T-40 socket or wrench.
- C. Install the new L-bracket on the frame using the factory hardware.
- D. Insert the new brake line into the L-bracket and thread the hardline to the soft line.
- E. Install brake line clip.

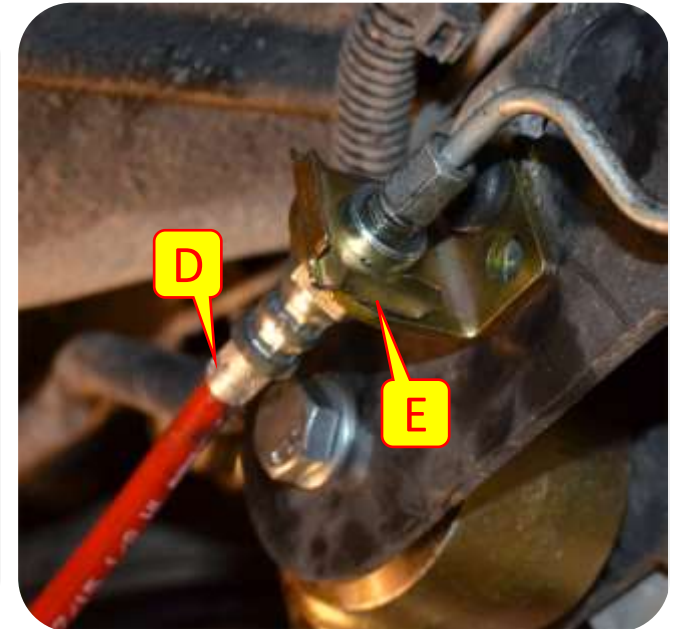
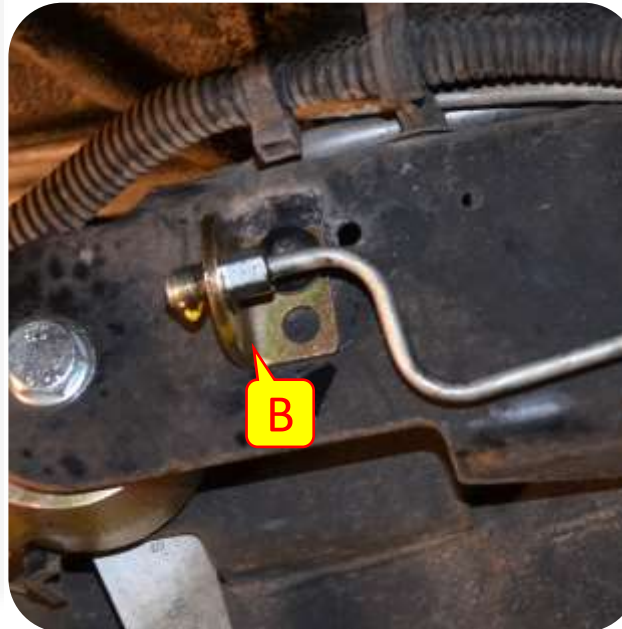
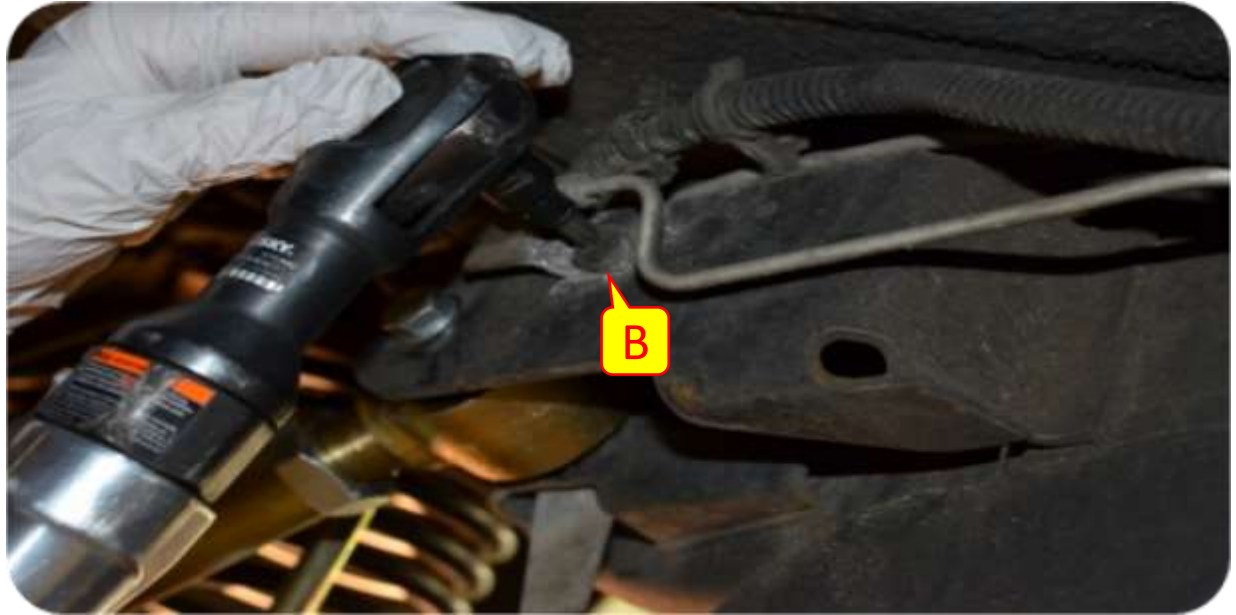



## Section 3: Installation Instructions

### Step 2: Install Brake Line at the Axle

- F. Loosen the hard lines from the factory T-block.
- G. Remove the axle vent bolt from the T-block and remove the factory brake line.
- H. Thread the hard lines into the new T-block of the new brake line.
- I. Re-install the axle vent bolt and vent tube.
- J. Tighten all three of the line nuts.

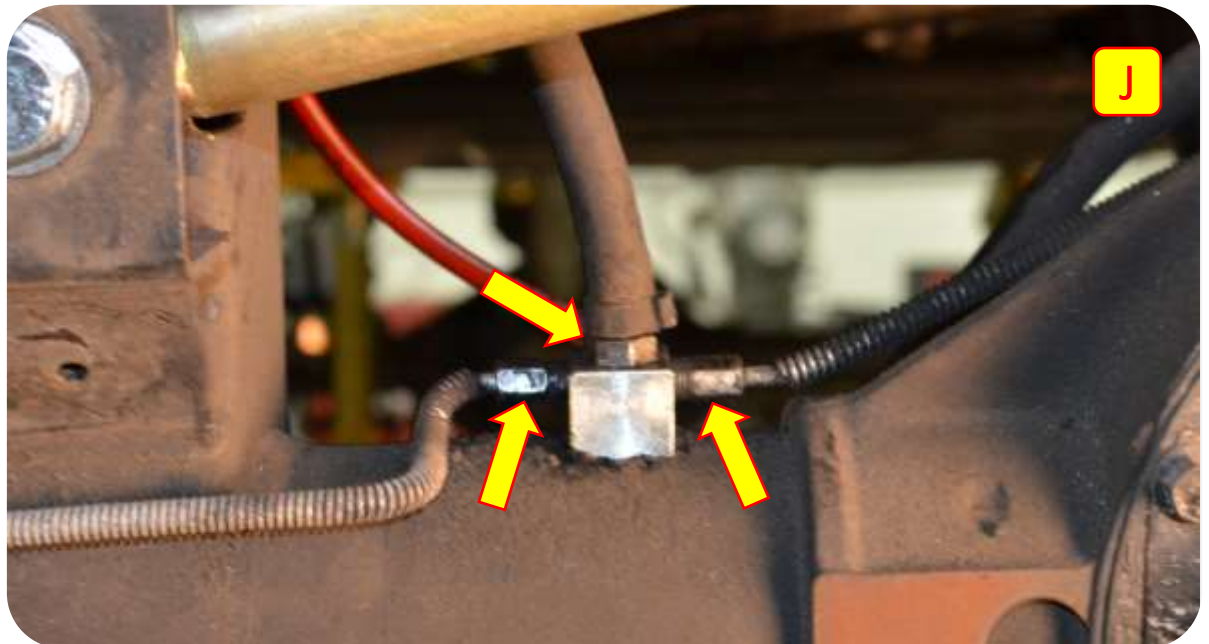
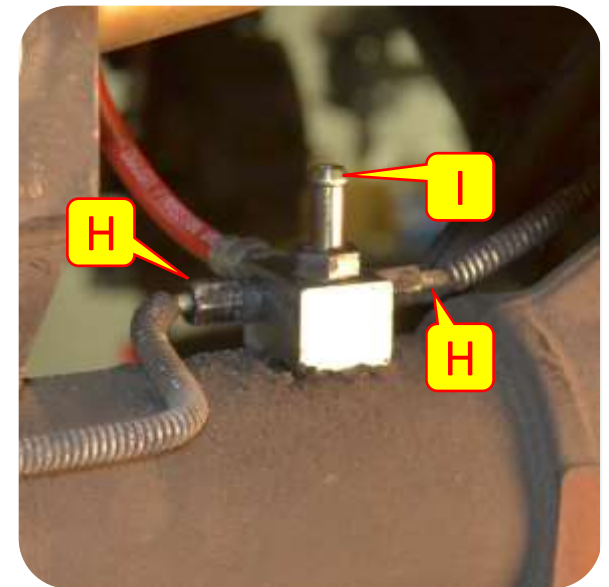
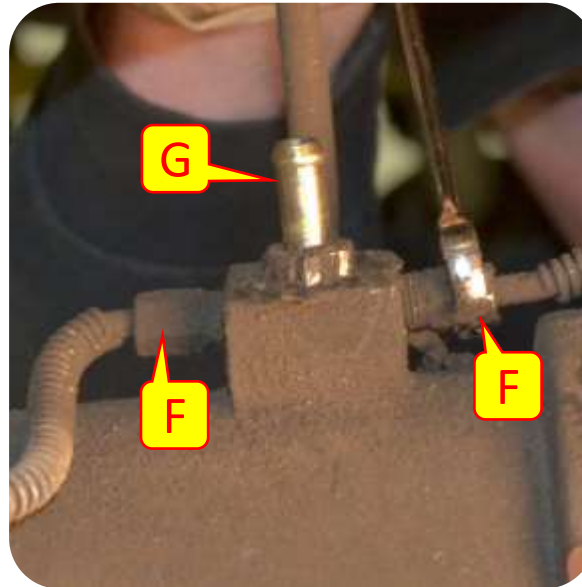

## Section 3: Installation Instructions



### Step 3: Bleed Brake Lines

**Important Note:** *Before driving bleed brake lines.*

