



Installation Instructions



PRODUCT: **Universal Accessory Mount**

REV: B | 06-26-2015 | II-3961

READ INSTRUCTIONS IN FULL BEFORE INSTALLATION.
QUESTIONS? CALL 916-631-8071 M-F 7:00 AM – 5:00 PM PST

The MetalCloak experience includes the ease of installation of our products. We design for most contingencies, but installation may be different based on different Jeep condition, configuration and/or year.

We are continually trying to improve our products and instructions – please help us by providing feedback and pictures if you find any part of the instructions that do not match your particular Jeep or are not easily understandable.

If you have any difficulties at all, please give us a call. Thank you and enjoy your MetalCloak Products!

IMPORTANT NOTE: We use Stainless Steel Hardware where possible. Therefore, a tube of Silver Anti-seize is provided and should be used on all bolts—only a small amount is needed.

WARRANTY INFORMATION: This article is sold without warranty expressed or implied. No warranty or representation is made as to this products ability to protect the user from injury or death. The user assumes that risk. The effectiveness, warranty and longevity of this equipment are directly related to the manner in which it is INSTALLED, USED and/or MAINTAINED. THE USER ASSUMES ALL RISK. By purchasing this product and opening the packaging, purchasers expressly acknowledge, understand and agree that they take, select and purchase these MetalCloak products from Armored Works, LLC, its affiliates and distributors and agents as is and with all faults. The entire risk as to the quality and performance of these MetalCloak products is with the purchaser. Working on your vehicle can be a dangerous activity. If you are unsure of what you are doing, please leave mechanical or safety critical work to a skilled mechanic. We take no responsibility for the incorrect use and/or installation of MetalCloak products.

Section 1: Tools & Notes on Installation

Tools Required: This list is the recommended tools for ease of installation. Other versions of the same tool can be used. For example, Allen Wrenches instead of Allen Drive Sockets. Be sure to use metric on metric and SAE on SAE.



Socket & Ratchet Wrench

5/16" Allen Drive Socket/Wrench



3/4" Wrench

Rubber Mallet
(Optional)



HOW TO USE THIS GUIDE: The installation guide contains ALL steps for installation. Please read and follow the instructions in order of each page from top to bottom, and left to right.

Jeep Model: Instructions may apply to multiple Jeep models, but are labeled separately where appropriate (i.e. TJ vs. LJ).

Options: Because of the number of component options we offer, these instructions may contain steps that will not match your particular configuration. You can skip these steps.

Images: Pictures are provided and parts are labeled throughout the instructions. Each text box contains guidance based on the pictures next to it. The text will refer to alphabetical labels (A, B, etc.) found in the images.

Installation Notes: Terms may be used in the body of the instructions that you may not be familiar with, if you have any questions feel free to contact us at the number below, or email techhelp@metalcloak.com

QUESTIONS: Any questions or comments about the instructions? Call us at 916-631-8071 M-F 7:00 AM – 5:00 PM PST.

Section 2: Product Components

DC-0001 REV A

SHEET 1 OF 1

ITEM	PART NUMBER/DESCRIPTION	QTY.
1	FA-0074 SBHCSCREW, 0.5-13 X 1.25L GR 8 BLACK ZINC	4
2	FA-1027 PLASTIC TUBE PLUG, 1.0OD X .63TH BLACK	2
3	FA-2040 NYLOCK FLANGE NUT, 0.5-13 STL ZNC PLTD	4
4	WM-3950 WELDMENT, ACCESSORY BRACKET	1

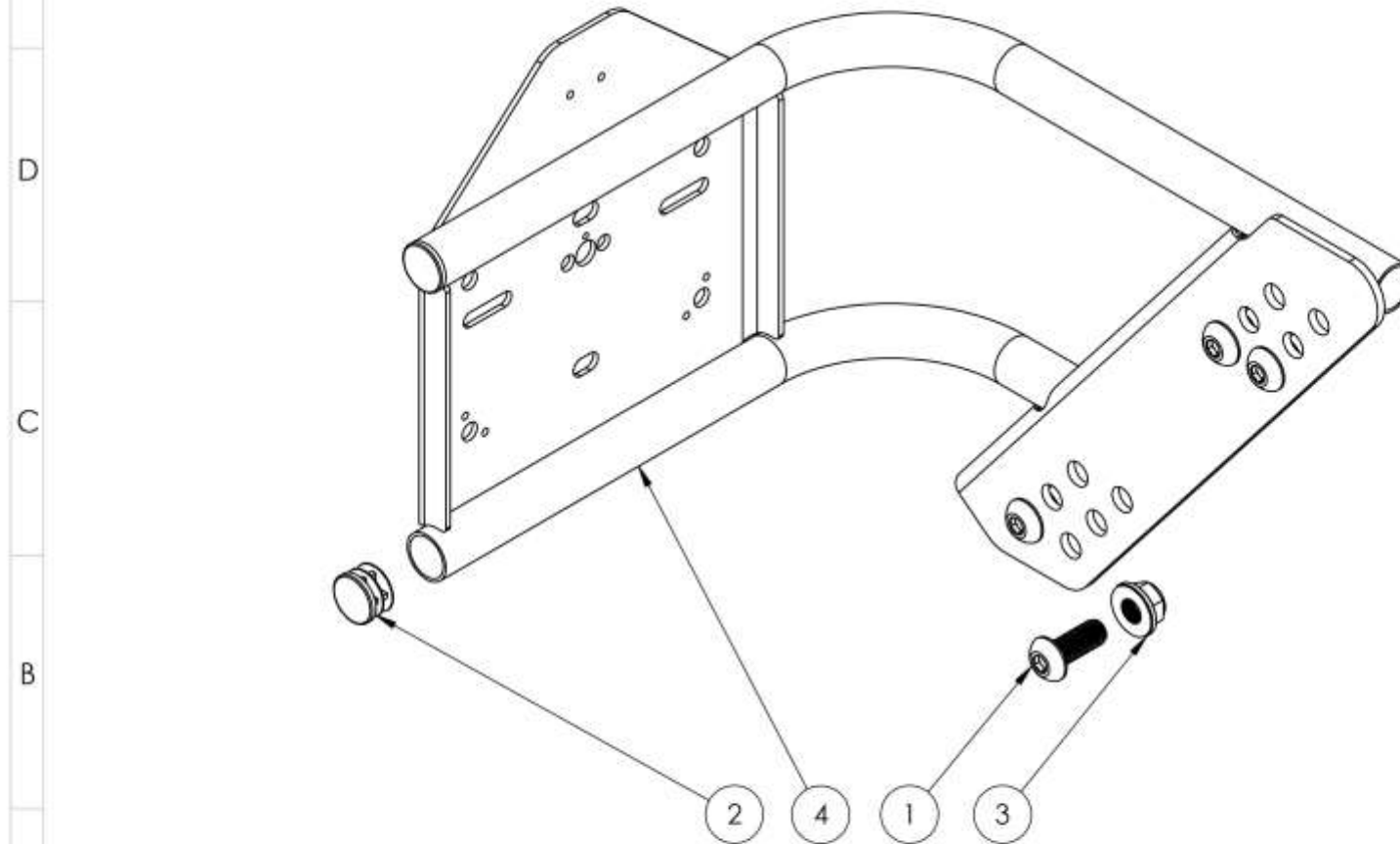

A	TOLERANCES UNLESS OTHERWISE SPECIFIED				THE INFORMATION CONTAINED ON THIS DRAWING IS THE EXCLUSIVE PROPERTY OF ARMORED WORKS, LLC. UNAUTHORIZED REPRODUCTION IS PROHIBITED. DO NOT SCALE DRAWING	 A DIVISION OF ARMORED WORKS, LLC
	DIMENSIONS ARE IN INCHES	DECIMAL	FRACTION	ANGULAR		
	ANGLES ARE 90 DEG UNLESS OTHERWISE SPECIFIED	.XX +/- .010 .XXX +/- .005	+/- 1/16	+/- 1 DEG	32 ✓	
	CURRENT REVISION	[A][BAM][06/04/13]	PRODUCTION RELEASE		PART NUMBER DESCRIPTION	3961 ACCESSORY MOUNT, REAR BUMPER, DRIVER SIDE
	PREVIOUS REVISION	[]				

Section 3: Installation Instructions

Step 1: Preparation for Universal Accessory Mount

- A. Tire must be installed to check proper alignment of the universal accessories mount before installation.
- B. Open tire carrier arm and lock into open position.
- C. Place the universal accessory mount on the accessory wing and align holes. You have three options for installation. Choose the best option for your tire size.
- D. Remove tire from the tire carrier.

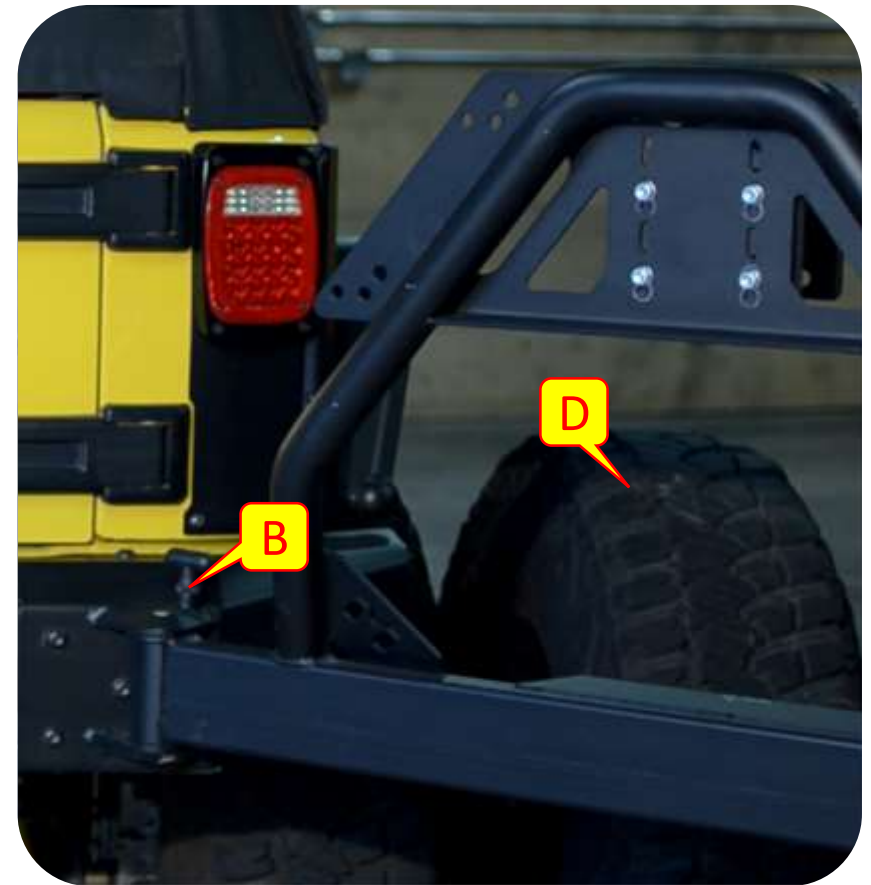
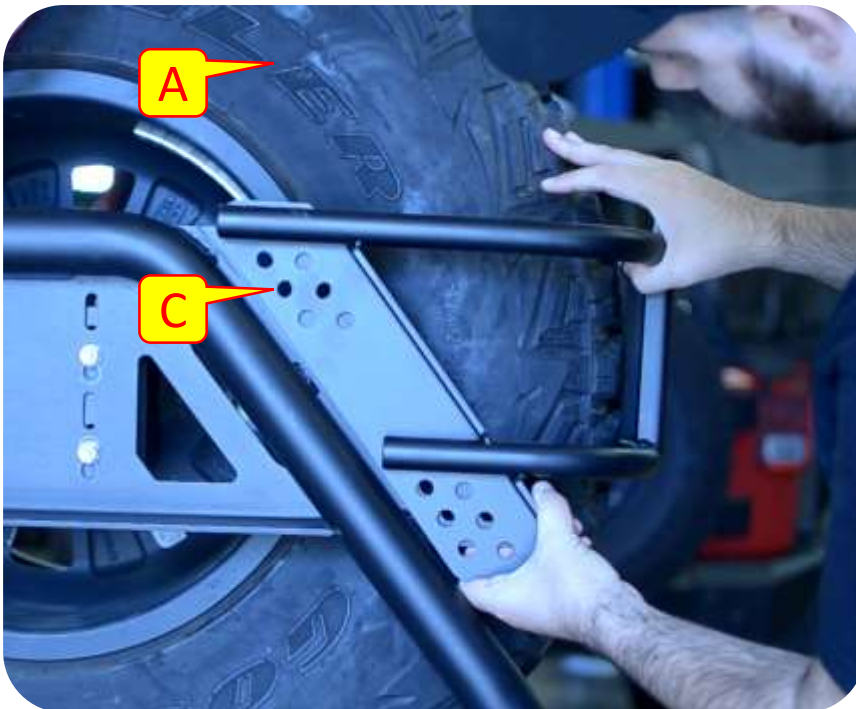

Section 3: Installation Instructions

Step 2: Install Universal Accessory Mount

- E. Place the universal accessory mount on the accessory wing and place bolts through the previously determined mounting location.
- F. Thread the nylock flange nuts onto the bolts.
- G. Use a 5/16" allen drive socket and a 3/4" wrench to tighten.
- H. Now insert the plastic tube plug into the two holes. You may need a rubber mallet to help insert these into the tube.
- I. Reinstall spare tire.

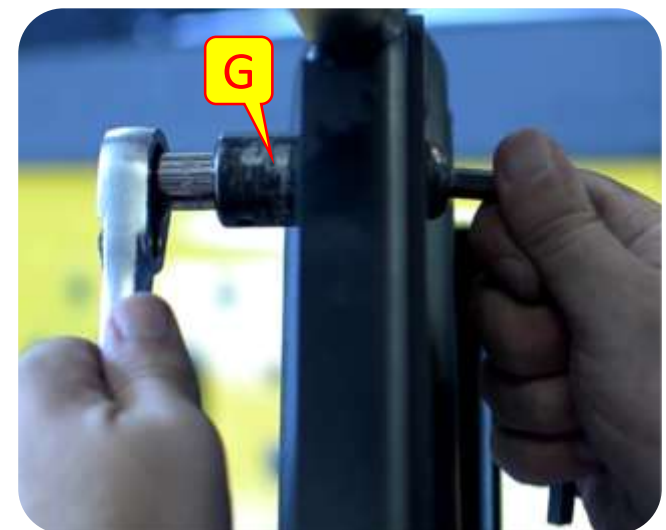
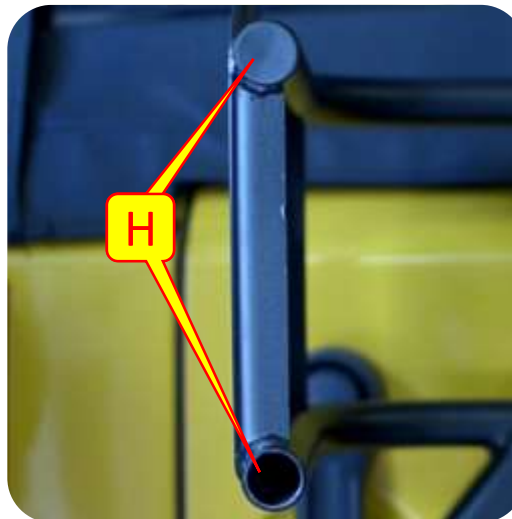
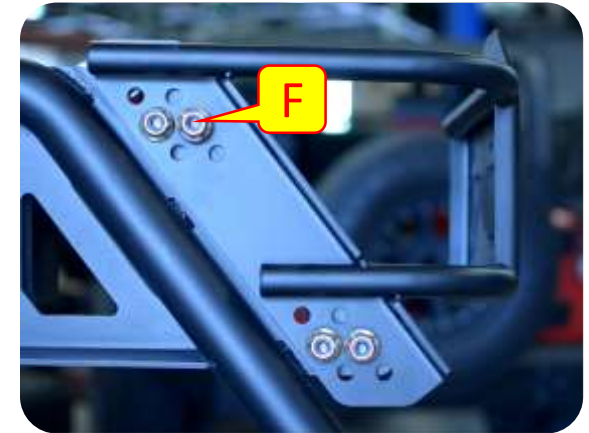

Section 2: Installation Instructions

Step 3: Accessory Options

Note: Though the MetalCloak Universal Accessory Mount shows a Roto-Pax™ attached. The Universal Accessory Mount will work with the following:

1. Can-Cams™
2. Roto-Pax™
3. Jerry Can Mount
4. Power Tank™ Mount



1. Can-Cams™



2. Roto-Pax™



3. Jerry Can Mount



4. Power Tank™ Mount