



## PRODUCT: JK Front Open Frame Tube Doors

REV: A | 03-23-2021 | II-4100

**READ INSTRUCTIONS IN FULL BEFORE INSTALLATION.**

**QUESTIONS? CALL 916-631-8071 M-F 7:00 AM – 5:00 PM PST**

The MetalCloak experience includes the ease of installation of our products. We design for most contingencies, but installation may be different based on different Jeep condition, configuration and/or year.

We are continually trying to improve our products and instructions – please help us by providing feedback and pictures if you find any part of the instructions that do not match your particular Jeep or are not easily understandable.

If you have any difficulties at all, please give us a call. Thank you and enjoy your MetalCloak Products!

**IMPORTANT NOTE: We use Stainless Steel Hardware where possible. Therefore, a tube of Silver Anti-seize is provided and should be used on all bolts—only a small amount is needed.**

**WARRANTY INFORMATION:** This article is sold without warranty expressed or implied. No warranty or representation is made as to this products ability to protect the user from injury or death. The user assumes that risk. The effectiveness, warranty and longevity of this equipment are directly related to the manner in which it is INSTALLED, USED and/or MAINTAINED. THE USER ASSUMES ALL RISK. By purchasing this product and opening the packaging, purchasers expressly acknowledge, understand and agree that they take, select and purchase these MetalCloak products from Armored Works, LLC, its affiliates and distributors and agents as is and with all faults. The entire risk as to the quality and performance of these MetalCloak products is with the purchaser. Working on your vehicle can be a dangerous activity. If you are unsure of what you are doing, please leave mechanical or safety critical work to a skilled mechanic. We take no responsibility for the incorrect use and/or installation of MetalCloak products.

## Section 1: Tools & Notes on Installation



**Tools Required:** This list is the recommended tools for ease of installation. Other versions of the same tool can be used. For example, Allen Wrenches instead of Allen Drive Sockets.



Ratchet

5/32 allen wrench or socket  
7/32 allen wrench or socket



T47 Torx Wrench

7/16" Wrench      9/16 Wrench



**HOW TO USE THIS GUIDE:** The installation guide contains ALL steps for installation. Please read and follow the instructions in order of each page top to bottom, and left to right.

**Jeep Model:** Instructions may apply to multiple Jeep models, but are labeled separately where appropriate (i.e. TJ vs. LJ).

**Options:** Because of the number of component options we offer, these instructions may contain steps that will not match your particular configuration. You can skip these steps.

**Images:** Pictures are provided and parts are labeled throughout the instructions. Each text box contains guidance based on the pictures next to it. The text will refer to alphabetical labels (A, B, etc.) found in the images.

**Installation Notes:** Terms may be used in the body of the instructions that you may not be familiar with, if you have any questions feel free to contact us at the number below, or email [techhelp@metalcloak.com](mailto:techhelp@metalcloak.com)

**QUESTIONS:** Any questions or comments about the instructions? Call us at 916-631-8071 M-F 7:00 AM – 5:00 PM PST.

# Section 2: Product Components



DC-0001 REV A

SHEET 1 OF 3

ITEM	PART NUMBER/DESCRIPTION	QTY.
1	CP-4108 STRAP BRACKET, TUBE DOOR, JK	1
2	CP-4108-P STRAP BRACKET, TUBE DOOR, JK	1
3	CP-4125 TUBE DOOR LATCH M PLATE, JK-JL	2
4	FA-1052 ROTORY LATCH, DRIVER, TUBE DOOR	1
5	FA-1053 ROTORY LATCH, PASSENGER, TUBE DOOR	1
6	FA-1055 TOGGLE CLAMP SPINDLE, 0.25-20 X 1.63L	2
7	FA-1056 ACTUATOR CABLE, TUBE DOOR, FRONT	2
8	FA-1059 ACTUATOR HANDLE, BLACK PLASTIC, TUBE DOOR	2
9	FA-1062 STRAP, TUBE DOOR	2
10	FA-2018 END PLUG, 1.25 X .53H BLK PLASTIC	8
11	FS-01018 SFHCS, 8-32 X 0.75L SS 18-8 PLAIN	4
12	FS-04005 NYLOCK NUT, 0.25-20 X 0.31H STL GF ZINC	4
13	FS-04006 SBHCS, 0.25-20 X 0.75L SS 18-8 PLAIN	4
14	FS-04206 THIN HEX NUT, 0.25-20 X 0.16H STL G5 ZINC	2
15	FS-04207 FLANGE SBHCS, 0.25-20 X 0.75L STL G5 ZINC	4
16	FS-06004 WASHER, 0.41ID X 0.81OD X 0.05TH SS 18-8	8
17	FS-06030 NYLOCK NUT, 0.38-16 X 0.45H STL GF ZINC	8
18	FS-06205 SFHCS, 0.38-16 X 1.25L SS 18-8 PLAIN	8
19	WM-4100 WELDMENT, TUBE DOOR, FRONT JK	1
20	WM-4100-P WELDMENT, TUBE DOOR, FRONT JK	1
21	WM-4102 WELDMENT, TUBE DOOR, HINGE, JK	2
22	WM-4102-P WELDMENT, TUBE DOOR, HINGE, JK	2
23	WM-4103 WELDMENT, LATCH PLATE, TUBE DOOR, JK	1
24	WM-4103-P WELDMENT, LATCH PLATE, TUBE DOOR, JK	1

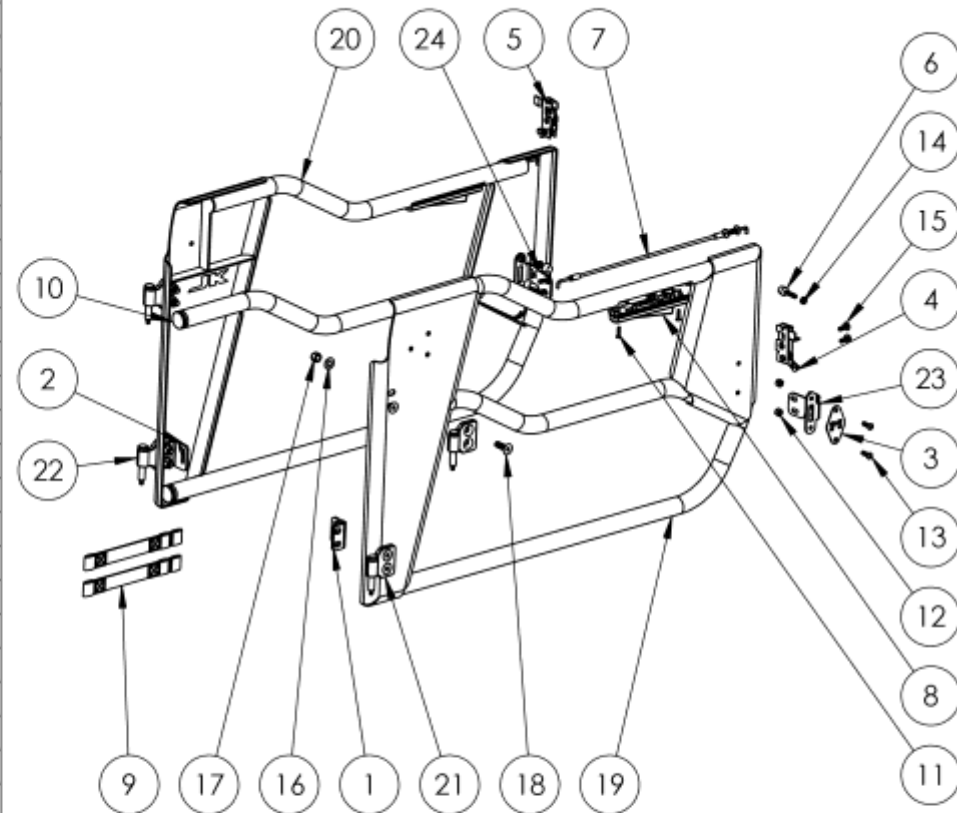

B

A

THE INFORMATION CONTAINED ON THIS DRAWING IS THE EXCLUSIVE PROPERTY OF ARMORED WORKS, LLC. UNAUTHORIZED REPRODUCTION IS PROHIBITED.  
**DO NOT SCALE DRAWING**



**PART NUMBER/DESCRIPTION**

**4100 TUBE DOOR, JK FRONT**

## Section 3: Installation Instructions

### Step 1: Remove Doors

**Note:** MetalCloak recommends you roll down the door windows before removing the stock doors.

- A. Disconnect the power window plug located under the dashboard.
- B. Remove the door strap from the hook.
- C. Using a T47 torx wrench remove the two outer hinge nut caps. **Save Hardware.**
- D. Remove door.

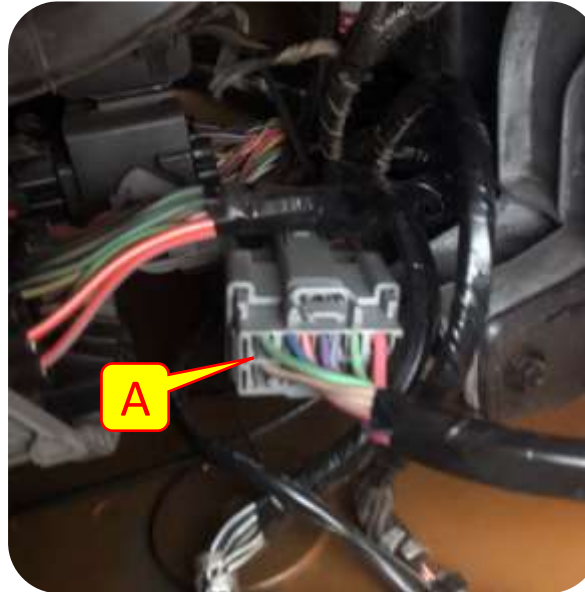

## Section 3: Installation Instructions

### Step 2: Latch Assembly

- E. Install the provided plugs into the exposed ends of the door tubes.
- F. Using the provided bolts install the M latch plate to the front of the door.
- G. Install the gold zined latch bracket to the back side of the M latch plate and secure with the provided nylock nuts.
- H. Using a 5/32 allen and a 7/16 wrench tighten the latch plate hardware.

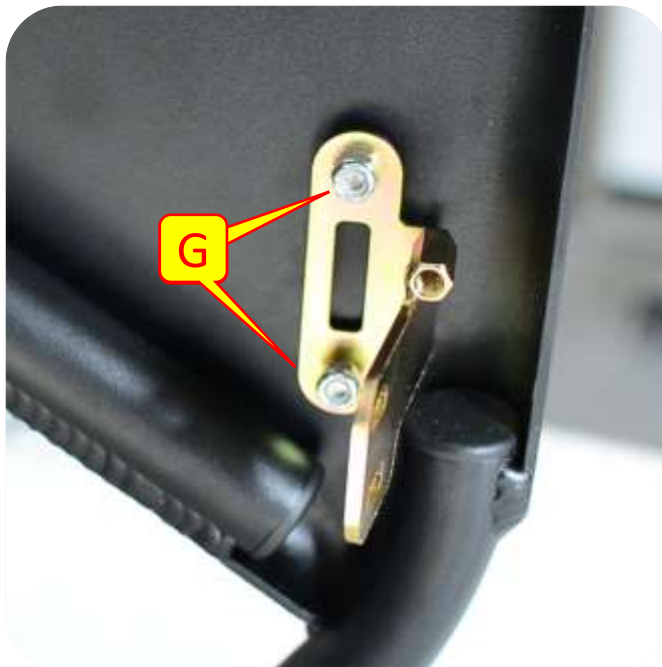

## Section 3: Installation Instructions

### Step 2: Latch Assembly

- I. Install the provided nut to the door stop bolt.
- J. Install the door stop bolt into the gold zinc latch bracket.
- K. Install the door handle hook (1) to the provided latch (2) and secure into place with the latch clips (3).
- L. Using the provided bolts install the latch to the gold zinc latch bracket snug using a 5/32 allen wrench.

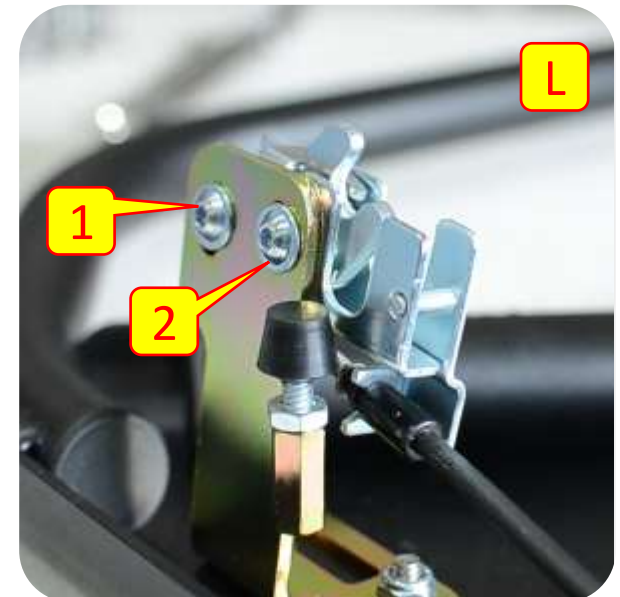
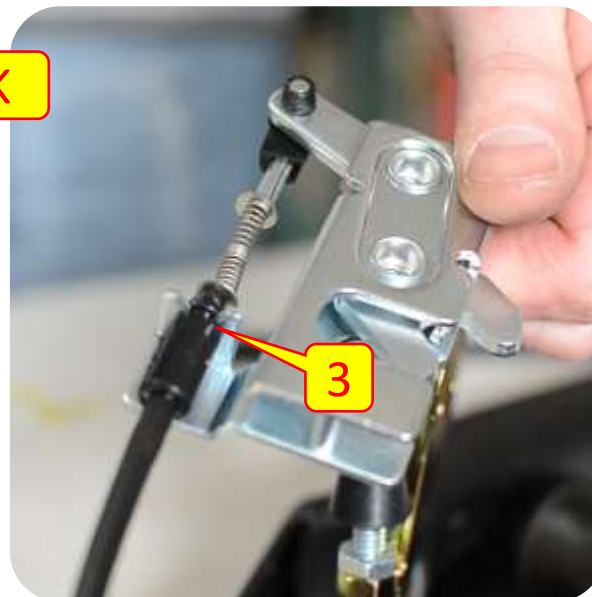
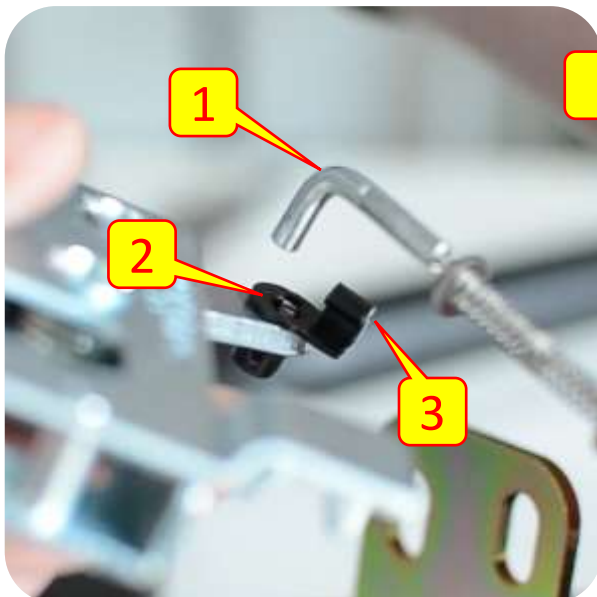

## Section 3: Installation Instructions

### Step 3: Billet Hinge Assembly

- M. Install the upper billet hinge with the provided washers, nuts, and countersunk bolts. Tighten the bolts snug using a 7/32" allen wrench and 9/16" wrench.
- N. Install the lower billet hinge (1) and the gold zinc door strap bracket (2) to the tube door. Tighten the bolts snug using a 7/32" allen wrench and 9/16" wrench.
- O. Install the provided door strap to the gold zinc bracket.

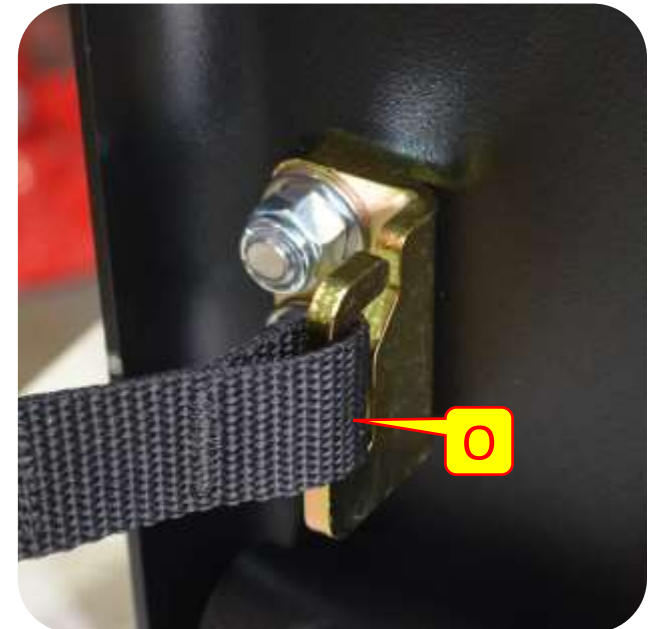
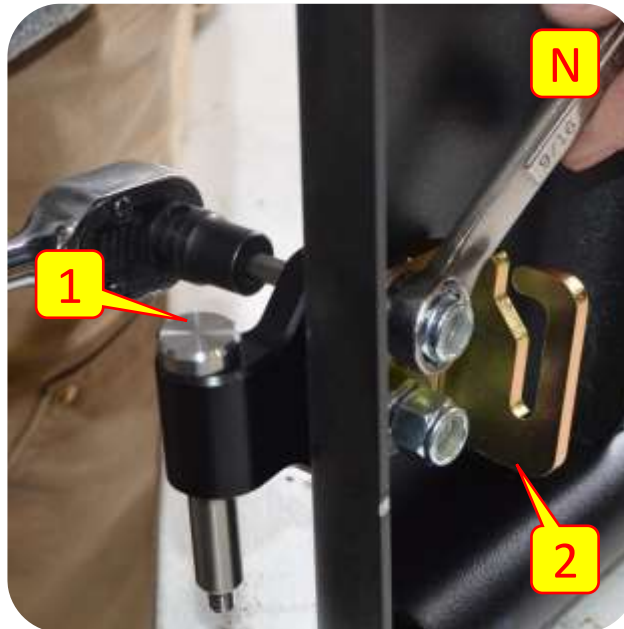
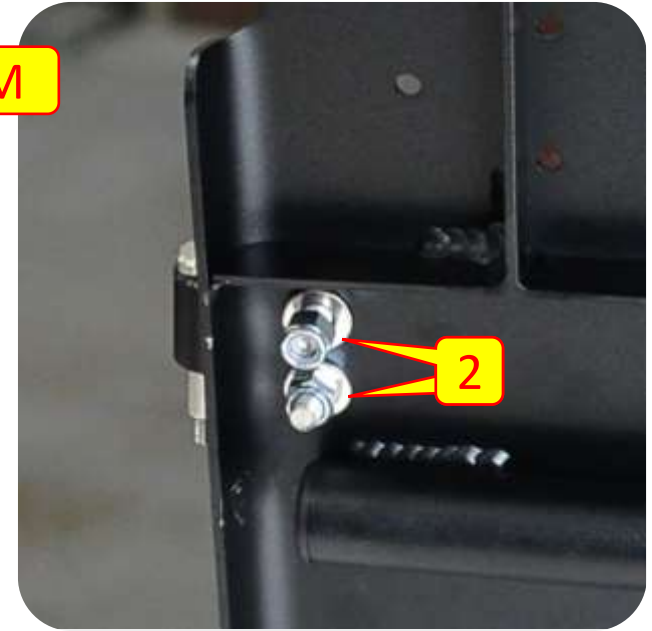

## Section 3: Installation Instructions

### Step 4: Tube Door Installation

- P. Install the tube door into the stock hinge locations (Q1) and snap the latch into place (Q2).
- Q. MetalCloak recommends having a second person lift on the door to help keep the door aligned when fully tightening the billet hinge hardware using a 7/32" allen wrench and a 9/16" wrench.





## Section 3: Installation Instructions



### Step 5: Tube Door Adjustments

- R. Make sure the door does not hit or connect with the door jam. If the door connects with the door jam or the door is not flush with the Jeep body, adjust the door latch to the desired location and then tighten the bolts using a 5/32 allen wrench. Make sure the door latches securely to the Jeep.

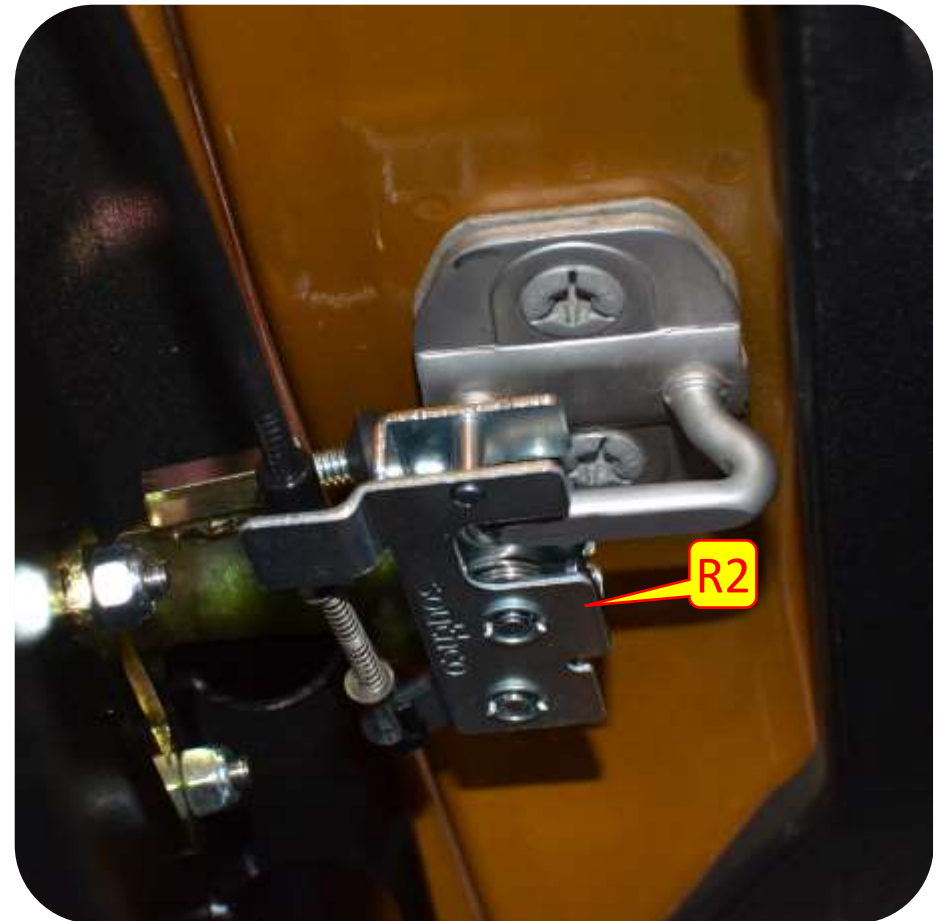

## Section 3: Installation Instructions

### Step 5: Tube Door Adjustments

- S. To prevent the door from rattling adjust the door latch stop. The door latch stop should hit the center of the latch hook on the body (S1). Adjust the door stop and shut the door, test the door for rattling, if the door rattles adjust the door stop again and continue until the rattling stops. Once satisfied use a 7/16" wrench to tighten the door stop nut (S2).

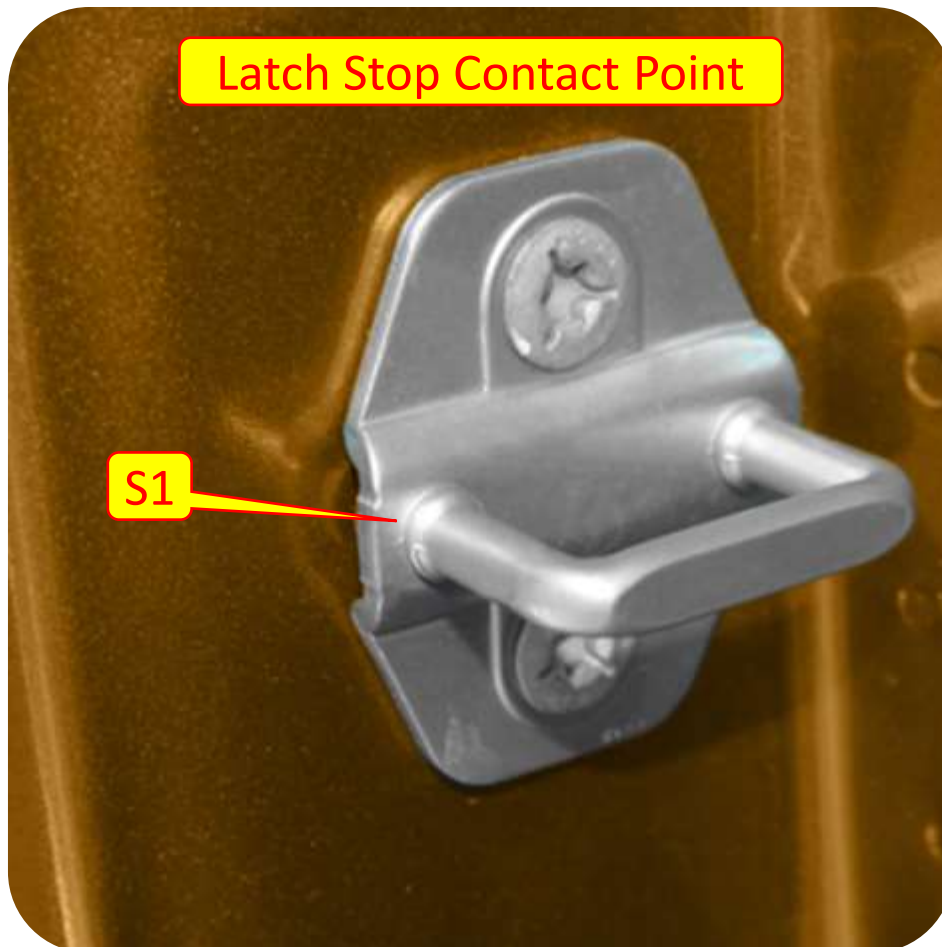

## Section 3: Installation Instructions



### Step 6: Final Assembly

- T. Once you have finished with the door adjustments connect the door strap to the stock strap hook.
- U. Using a T47 torx wrench reinstall and tighten the stock hinge nut cap.

