



PRODUCT: JL 2-Door UnderCloak System, 3.6L Motor

REV: C | 10-21-2019 | II-6362

READ INSTRUCTIONS IN FULL BEFORE INSTALLATION.

QUESTIONS? CALL 916-631-8071 M-F 7:00 AM – 5:00 PM PST

The MetalCloak experience includes the ease of installation of our products. We design for most contingencies, but installation may be different based on different Jeep condition, configuration and/or year.

We are continually trying to improve our products and instructions – please help us by providing feedback and pictures if you find any part of the instructions that do not match your particular Jeep or are not easily understandable.

If you have any difficulties at all, please give us a call. Thank you and enjoy your MetalCloak Products!

IMPORTANT NOTE: We use Stainless Steel Hardware where possible. Therefore, a tube of Silver Anti-seize is provided and should be used on all bolts—only a small amount is needed.

WARRANTY INFORMATION: This article is sold without warranty expressed or implied. No warranty or representation is made as to this products ability to protect the user from injury or death. The user assumes that risk. The effectiveness, warranty and longevity of this equipment are directly related to the manner in which it is INSTALLED, USED and/or MAINTAINED. THE USER ASSUMES ALL RISK. By purchasing this product and opening the packaging, purchasers expressly acknowledge, understand and agree that they take, select and purchase these MetalCloak products from Armored Works, LLC, its affiliates and distributors and agents as is and with all faults. The entire risk as to the quality and performance of these MetalCloak products is with the purchaser. Working on your vehicle can be a dangerous activity. If you are unsure of what you are doing, please leave mechanical or safety critical work to a skilled mechanic. We take no responsibility for the incorrect use and/or installation of MetalCloak products.

Section 1: Tools & Notes on Installation



Tools Required: This list is the recommended tools for ease of installation. Other versions of the same tool can be used. For example, Allen Wrenches instead of Allen Drive Sockets.



Socket & Ratchet Wrench

13mm Socket/Wrench
18mm Socket/Wrench
3/4" Socket/Wrench
9/16" Socket/Wrench



8mm Allen Socket or wrench

11/16" Drill Bit



Drill

HOW TO USE THIS GUIDE: The installation guide contains ALL steps for installation. Please read and follow the instructions in order of each page top to bottom, and left to right.

Jeep Model: Instructions may apply to multiple Jeep models, but are labeled separately where appropriate (i.e. TJ vs. LJ).

Options: Because of the number of component options we offer, these instructions may contain steps that will not match your particular configuration. You can skip these steps.

Images: Pictures are provided and parts are labeled throughout the instructions. Each text box contains guidance based on the pictures next to it. The text will refer to alphabetical labels (A, B, etc.) found in the images.

Installation Notes: Terms may be used in the body of the instructions that you may not be familiar with, if you have any questions feel free to contact us at the number below, or email techhelp@metalcloak.com

QUESTIONS: Any questions or comments about the instructions? Call us at 916-631-8071 M-F 7:00 AM – 5:00 PM PST.

Section 2: Product Components



DC-0001 REV A

SHEET 1 OF 1

ITEM	PART NUMBER/DESCRIPTION	QTY.
1	8998 INSTALLATION TOOL, 0.50-13 RIVET NUT	1
2	CP-3084-G BEVELED SKID WASHER	1
3	CP-6081 GUSSET STRAP, MOTOR SKID, JL DRIVE	1
4	CP-6084 REAR GUSSET STRAP, GAS TANK SKID, JL	1
5	CP-6085 BEVELLED SKID WASHER, 90DEG	7
6	CP-6114 GUSSET STRAP, 3.6L MOTOR SKID, JL PASS	1
7	FM-12188 SFHCS, M12-1.5 X 45L STL C10.9 CLEAR ZINC	7
8	FS-06030 NYLOCK NUT, 0.38-16 X 0.45H STL GF ZINC	2
9	FS-06031 HHCS, 0.38-16 X 1.0L STL G5 ZINC	1
10	FS-06181 SFHCS, 0.38-16 X 1.00L SS 18-8 PLAIN	1
11	FS-08061 HHCS, 0.5-13 X 1.25L STL G8 ZINC	4
12	FS-08081 SFHCS, 0.5-13 X 1.75L STL G8 ZINC	1
13	FS-08082 RIVET NUT, 0.5-13 X 0.20GRIP STL G5 GOLD ZINC	1
14	FS-08127 NYLOCK FLANGE NUT, 0.5-13 X 0.56H STL GF ZINC	4
15	WM-6074 WELDMENT, TRANSMISSION SKID PLATE, JL	1
16	WM-6075 WELDMENT, 3.6L MOTOR SKID PLATE, JL	1
17	WM-6076 WELDMENT, GAS TANK SKID PLATE, JL	1

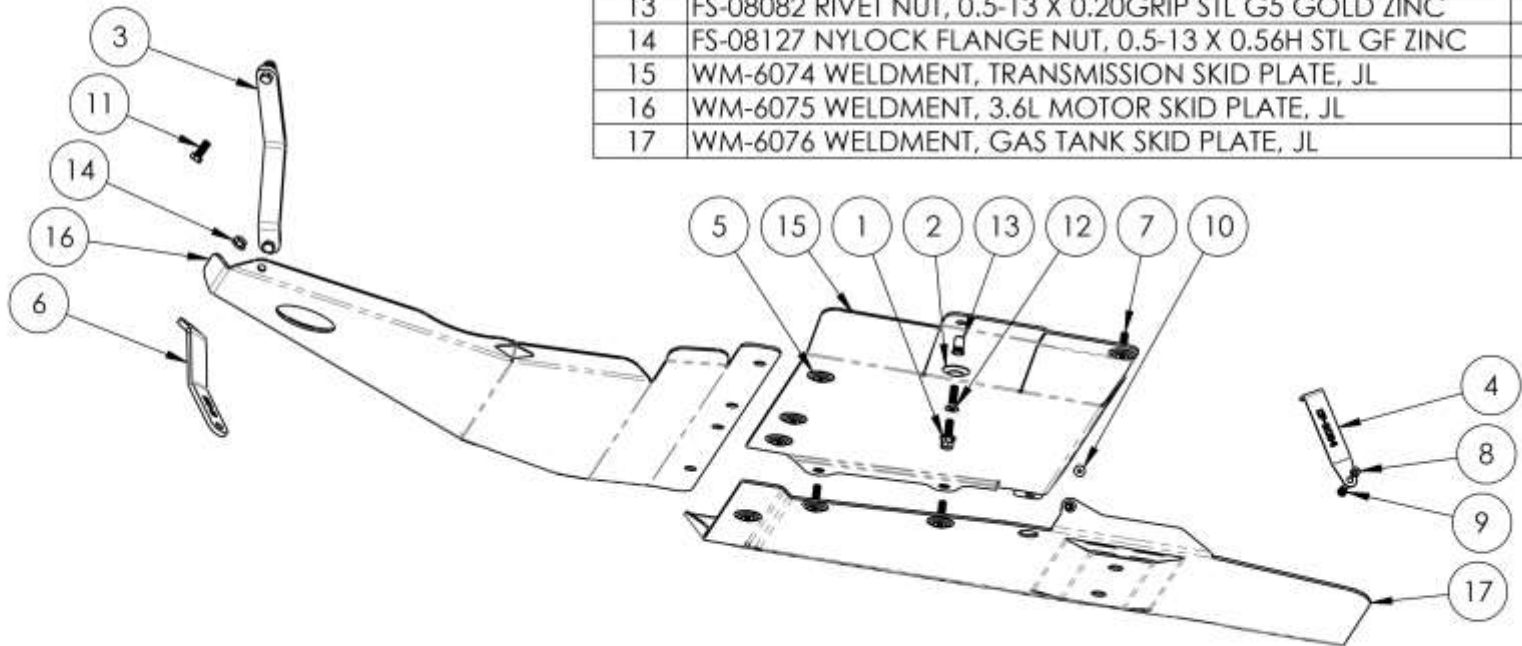

THE INFORMATION CONTAINED ON THIS DRAWING IS THE EXCLUSIVE PROPERTY OF ARMORED WORKS, LLC. UNAUTHORIZED REPRODUCTION IS PROHIBITED.

DO NOT SCALE DRAWING



A DIVISION OF ARMORED WORKS, LLC

PART NUMBER/DESCRIPTION

6362 SKID PLATE SYSTEM, 3.6L JL

Section 3: Installation Instructions

Step 1: Remove Stock Components

- A. Using a 13mm socket, remove the nut from the stock transmission skid. **Save All Hardware.**
- B. Using an 18mm socket, remove the bolts from the stock transmission and transfer case skids (*1 bolt will be reused*).
- C. Remove fuel line retainer from the gas tank front skid.

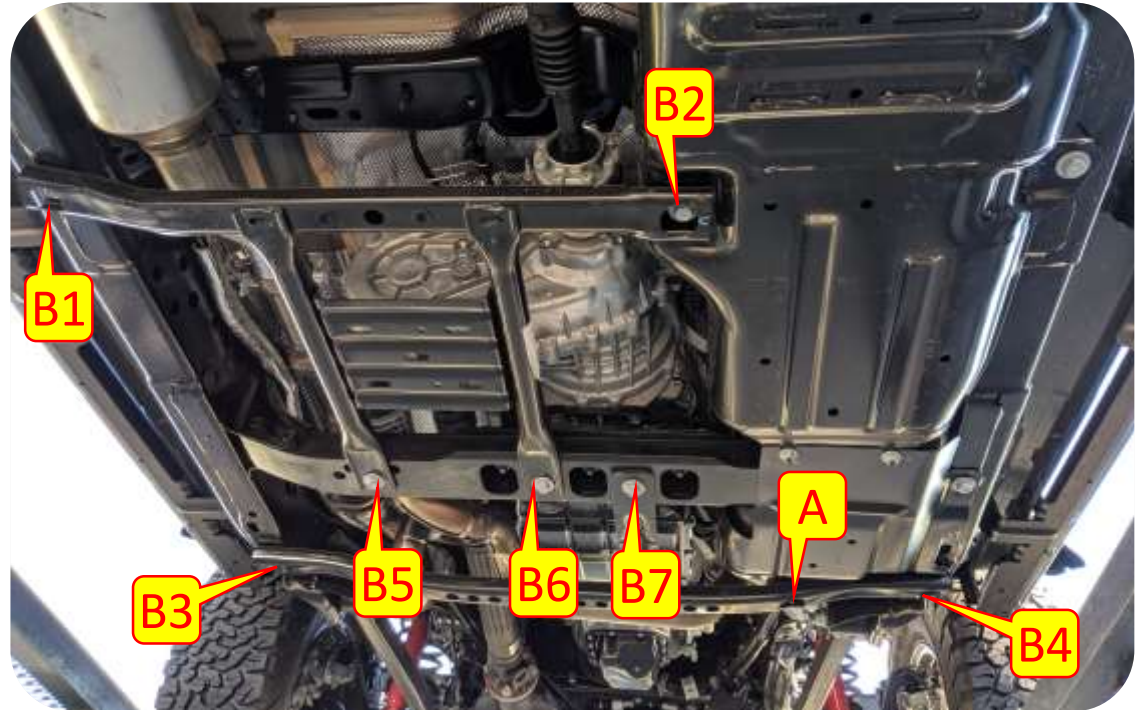

Section 3: Installation Instructions

Step 1: Remove Stock Components

- D. Using a 13mm socket, remove the nuts from the gas tank skid.
- E. Using an 18mm socket, remove the bolts from the gas tank front skid and remove it. 1 bolt will be reused. The skid will not be reused.
- F. Using a 18mm socket disconnect the three bolts on the stock gas tank skid at the frame. **Save all Hardware.**
- G. Using the provided hardware and an 8MM Allen wrench install the transfer case skid plate snug. Do not fully tighten.

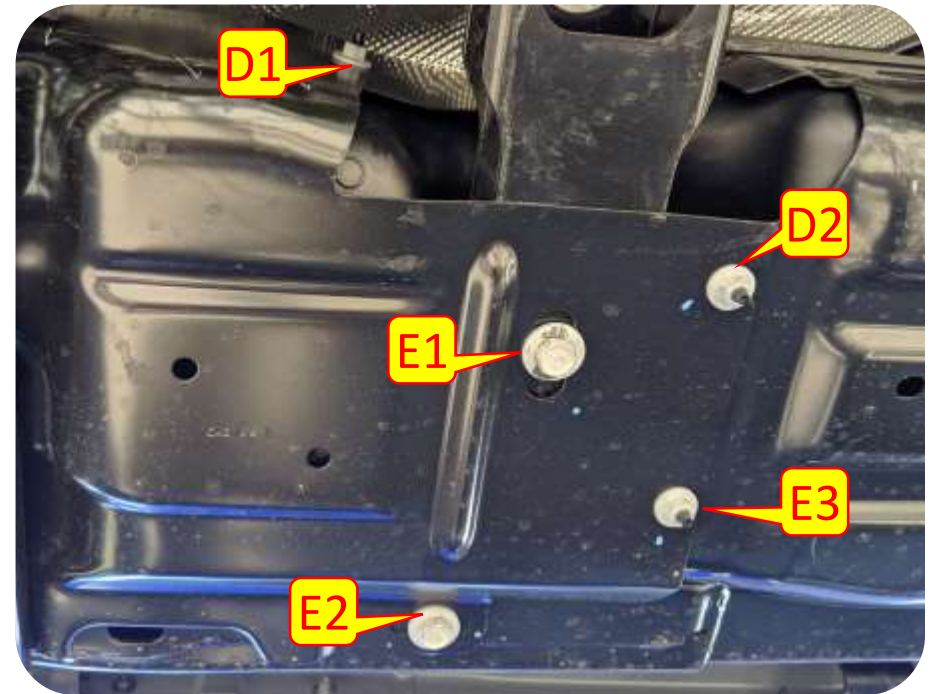

Section 3: Installation Instructions

Step 1: Installing the JL UnderCloak System

- H. Mark and center punch the hole on the frame for the transfer case skid plate.
- I. Remove the transfer case skid plate using an 8mm allen wrench.
- J. Using a 11/16 drill bit or step bit drill out the marked location on the frame.
- K. Using a 3/4" wrench and socket or rivet nut installation tool install the provided rivet nut.

Note: MetalCloak recommends painting any exposed metal to help prevent rust.

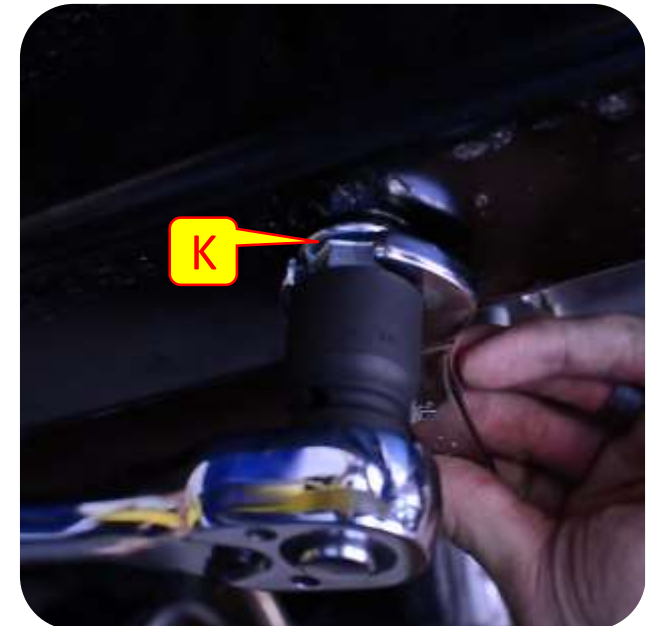
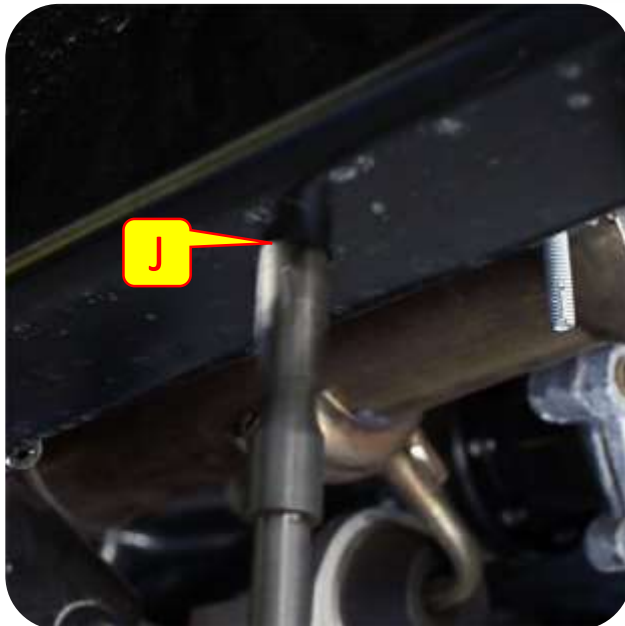

Section 3: Installation Instructions

Step 2: Transmission Skid Installation

- L. Fully tighten both bolts at the frame using an 8mm wrench.
- M. Disconnect the three counter sunk bolts on the transfer case skid plate on the crossmember in preparation for installing the motor skid plate.



Section 3: Installation Instructions



Step 3: Motor Skid Installation

N. Install the saved stock bolt into the motor skid tab at the frame hand tight.

Important Note: *Each motor mount bracket has a square hole and a round hole. The round hole attaches to the frame.*

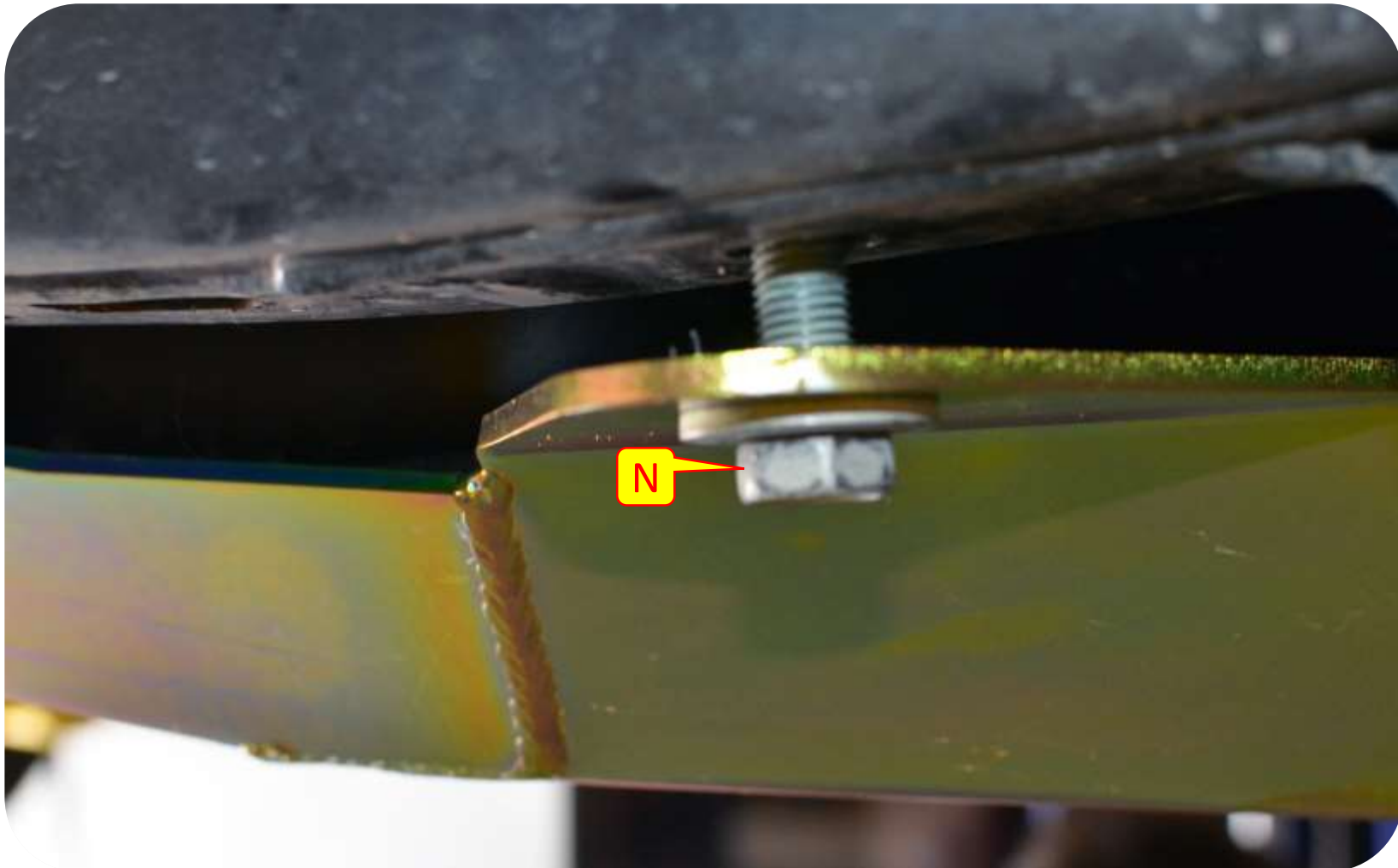

Section 3: Installation Instructions

Step 3: Motor Skid Installation

- O. Using an 8mm allen wrench attach the motor skid plate to the transfer case skid plate using the counter sunk bolts.
- P. Install the front brackets to the motor skid hand tight. Make sure the bracket is installed on the inside of the skid plate. *(The longer bracket is for the driver side and the shorter bracket is for the passenger side).*
- Q. Install the front bracket to the first hole on the frame side motor mount bracket hand tight.
- R. Using a 3/4" socket and wrench fully tighten the front motor mount brackets.

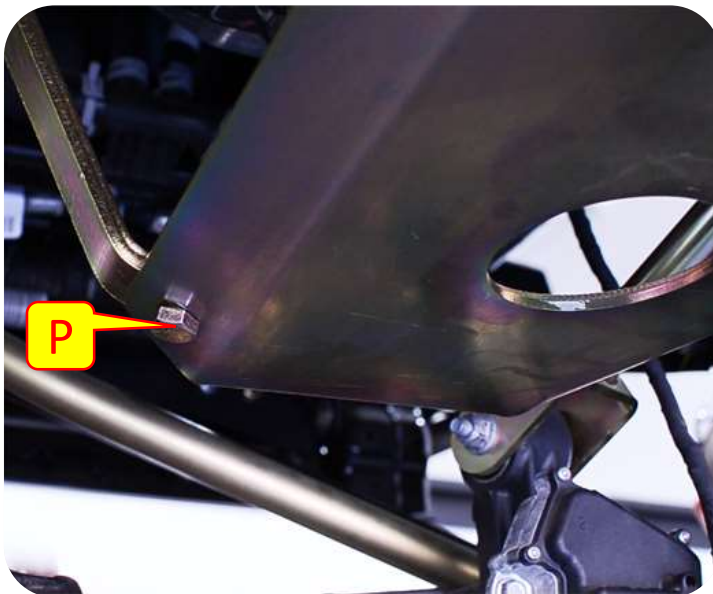
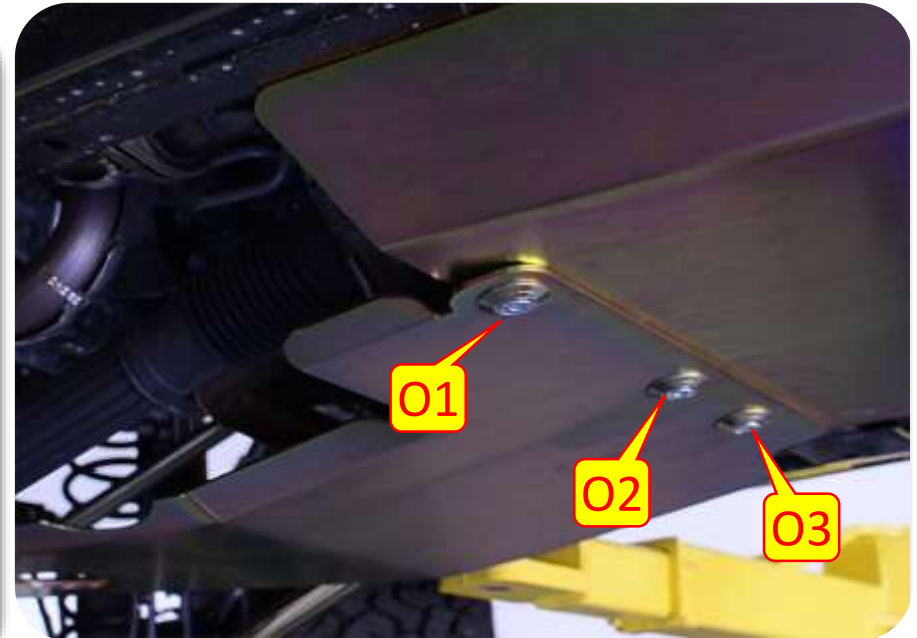

Section 3: Installation Instructions

Step 4: Gas Tank Skid Installation

- S. Using an 8mm allen wrench fully tighten the motor skid/transfer skid bolts.
- T. Attach the gas tank skid plate to the frame with the stock hardware hand tight.
- U. Using an 8mm allen wrench attach the gas tank skid to the cross member.
- V. Using an 8mm allen wrench attach the gas tank skid to the transfer case skid.

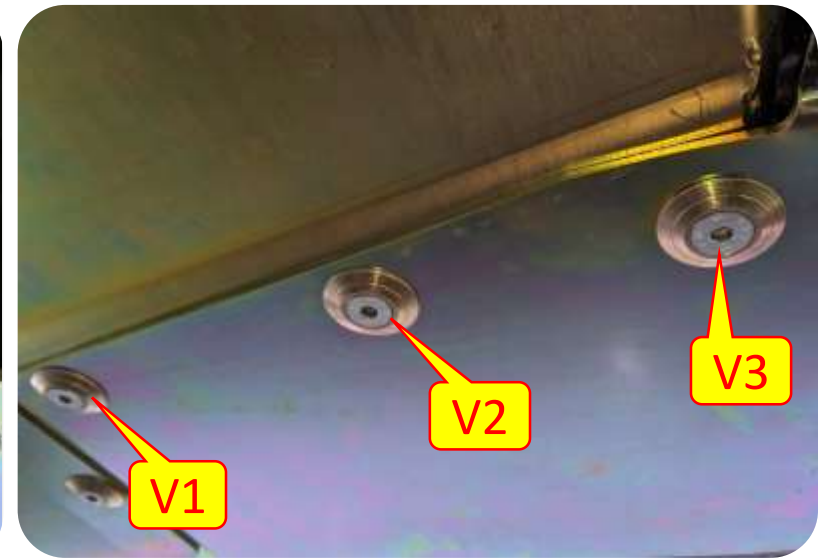
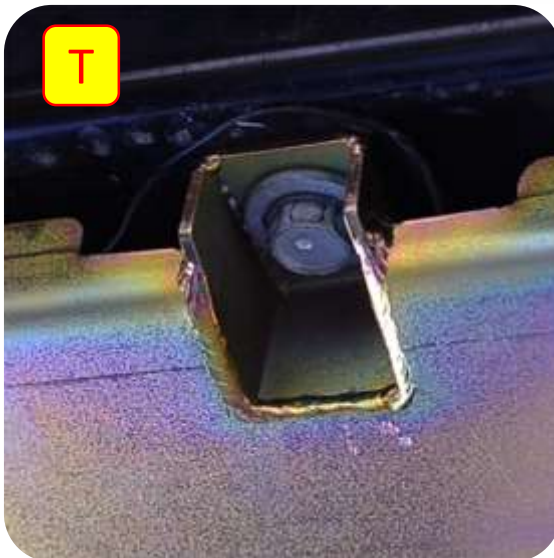

Section 3: Installation Instructions



Step 4: Gas Tank Skid Installation

- W. Using a 18mm socket disconnect the stock gas tank skid rear frame bolt. Save hardware.
- X. Using the stock bolt install the rear gas tank skid bracket to the frame hand tight.
- Y. Using the provided bolt install the gas tank skid bracket to the gas tank skid and tighten with a 9/16 socket and wrench.
- Z. Tighten ALL hardware.

