



PRODUCT: JL SportGate Tire Carrier

REV: A | 11-12-2019 | II-6950

**READ INSTRUCTIONS IN FULL BEFORE INSTALLATION.
QUESTIONS? CALL 916-631-8071 M-F 7:00 AM – 5:00 PM PST**

The MetalCloak experience includes the ease of installation of our products. We design for most contingencies, but installation may be different based on different Jeep condition, configuration and/or year.

We are continually trying to improve our products and instructions – please help us by providing feedback and pictures if you find any part of the instructions that do not match your particular Jeep or are not easily understandable.

If you have any difficulties at all, please give us a call. Thank you and enjoy your MetalCloak Products!

IMPORTANT NOTE: We use Stainless Steel Hardware where possible. Therefore, a tube of Silver Anti-seize is provided and should be used on all bolts—only a small amount is needed.

WARRANTY INFORMATION: This article is sold without warranty expressed or implied. No warranty or representation is made as to this products ability to protect the user from injury or death. The user assumes that risk. The effectiveness, warranty and longevity of this equipment are directly related to the manner in which it is INSTALLED, USED and/or MAINTAINED. THE USER ASSUMES ALL RISK. By purchasing this product and opening the packaging, purchasers expressly acknowledge, understand and agree that they take, select and purchase these MetalCloak products from Armored Works, LLC, its affiliates and distributors and agents as is and with all faults. The entire risk as to the quality and performance of these MetalCloak products is with the purchaser. Working on your vehicle can be a dangerous activity. If you are unsure of what you are doing, please leave mechanical or safety critical work to a skilled mechanic. We take no responsibility for the incorrect use and/or installation of MetalCloak products.

Section 1: Tools & Notes on Installation

Tools Required: This list is the recommended tools for ease of installation. Other versions of the same tool can be used. For example, Allen Wrenches instead of Allen Drive Sockets.



Wire Cutter

T8 Torx Wrench
T25 Torx Wrench
T55 Torx Wrench

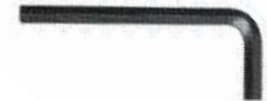

Socket Wrench

13MM Socket
9/16 Socket



5/32 Allen Wrench
5/16 Allen Wrench

7/16 Wrench
9/16 Wrench



Pry bar

HOW TO USE THIS GUIDE: The installation guide contains ALL steps for installation. Please read and follow the instructions in order of each page from top to bottom, and left to right.

Jeep Model: Instructions may apply to multiple Jeep models, but are labeled separately where appropriate (i.e. TJ vs. LJ).

Options: Because of the number of component options we offer, these instructions may contain steps that will not match your particular configuration. You can skip these steps.

Images: Pictures are provided and parts are labeled throughout the instructions. Each text box contains guidance based on the pictures next to it. The text will refer to alphabetical labels (A, B, etc.) found in the images.

Installation Notes: Terms may be used in the body of the instructions that you may not be familiar with, if you have any questions feel free to contact us at the number below, or email techhelp@metalcloak.com

QUESTIONS: Any questions or comments about the instructions? Call us at 916-631-8071 M-F 7:00 AM – 5:00 PM PST.

Section 2: Product Components

DC-0001 REV A

SHEET 1 OF 1

ITEM	PART NUMBER/DESCRIPTION	QTY.
1	6954 SPORTGATE TIRE MOUNT, 3.75 TO 5.25 MOUNT JL	1
2	FM-08094 HHCS SERRATED FLANGE, M8-1.25 X 25L STL C8.8 ZINC	8
3	FM-10202-BZ SHCS, M10-1.5 X 60L STL C10.9 BLACK ZINC	4
4	FM-10203 LOCK WASHER SPLIT, 10.7ID X 16OD X 2.3TH SS 18-8 PLAIN	4
5	FS-06001-BZ SBHCS, 0.38-16 X 0.75L STL G5 BLACK ZINC	4
6	WM-6970 WELDMENT, SPORTGATE, JL	1

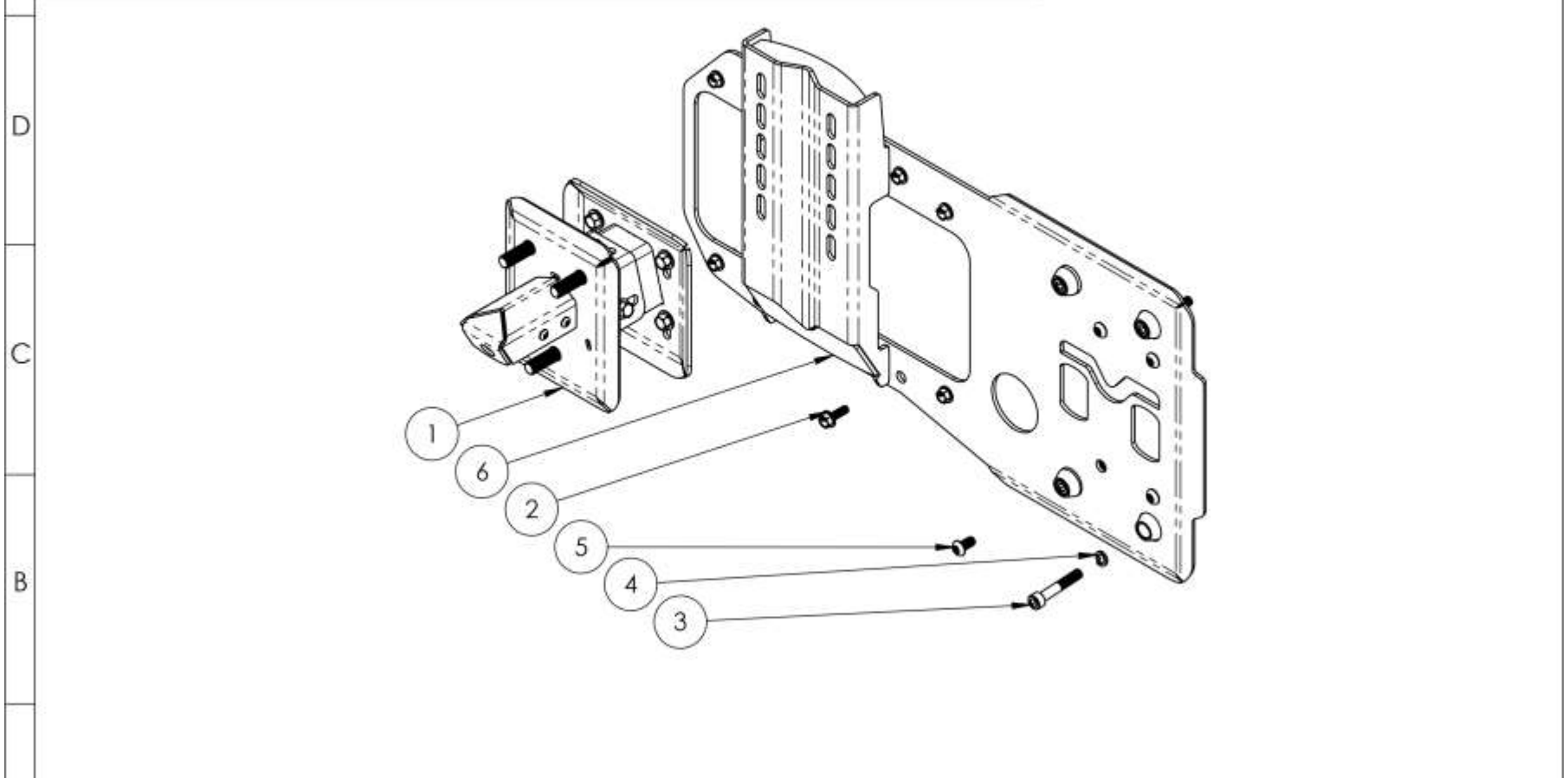

A	THE INFORMATION CONTAINED ON THIS DRAWING IS THE EXCLUSIVE PROPERTY OF ARMORED WORKS, LLC. UNAUTHORIZED REPRODUCTION IS PROHIBITED. DO NOT SCALE DRAWING	 A DIVISION OF ARMORED WORKS, LLC
	PART NUMBER/DESCRIPTION	

Section 3: Installation Instructions

Step 1: Preparation for SportGate Tire Carrier

- A. Open the tail gate and remove the plastic trim using a pry tool.”
- B. Disconnect the third brake light and camera wiring connectors.
- C. Remove the rubber grommet from the tail gate and pull the taillight wiring out of the tail gate.
- D. Open the wire cover and cut the white with green stripe and small black wires and remove the wiring leading to the third brake light from the wiring cover.

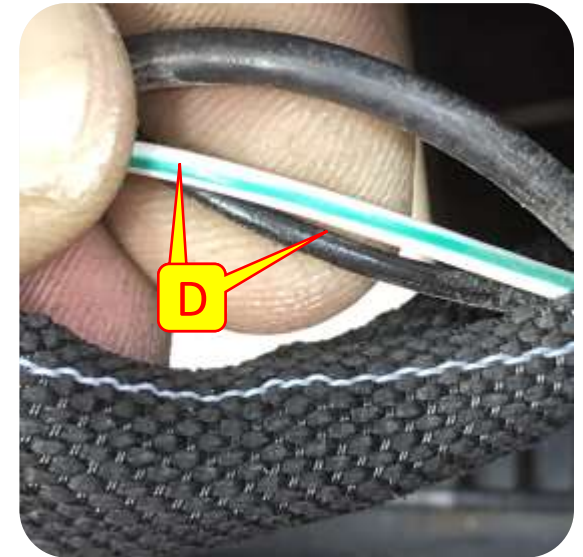
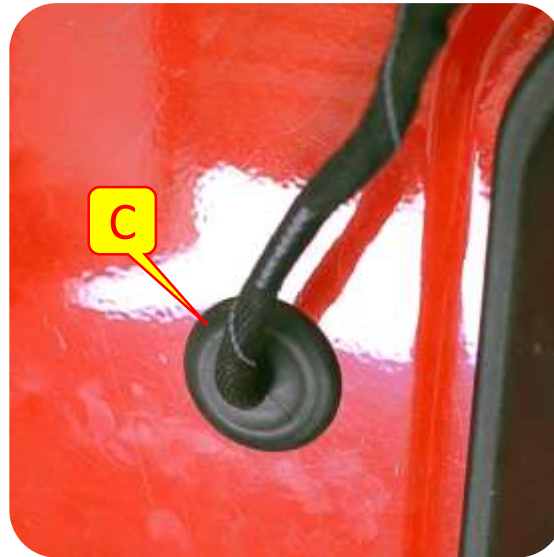
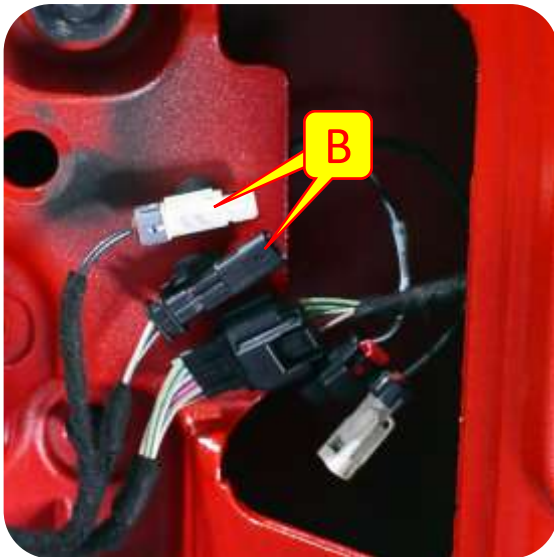

Section 3: Installation Instructions



Step 2: Backup Camera Removal

- E. Using a 13mm socket remove the stock tire carrier mount. If the spare tire is mounted remove the spare tire.
- F. Remove the back up camera wiring from the stock spare tire mount.
- G. Using a T25 torx wrench remove the bolts holding the camera mount into place on the spare tire mount.

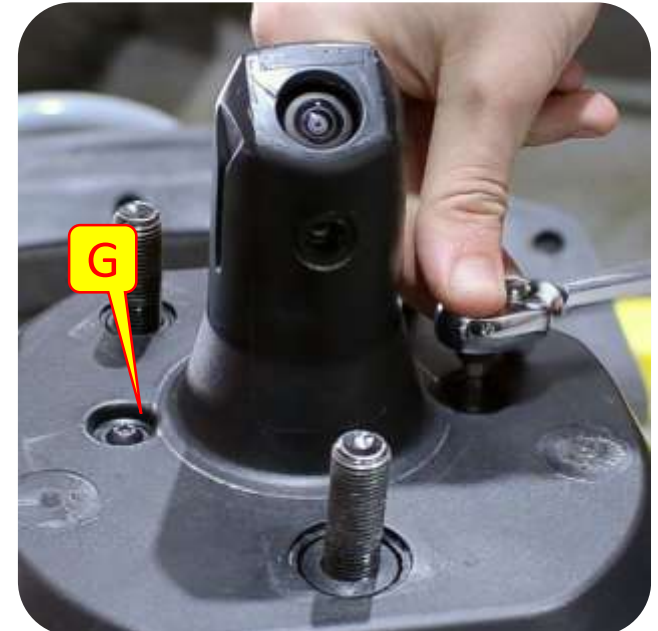

Section 3: Installation Instructions

Step 2: Backup Camera Removal

- H. Remove the camera mount from the inside of the tire mount.
- I. Using a T8 torx wrench remove the 3 screws holding the rear camera into place. **SAVE HARDWARE.**
- J. Disconnect the rear camera from the wiring.
- K. Remove the wiring from the camera mount. **SAVE WIRING.**

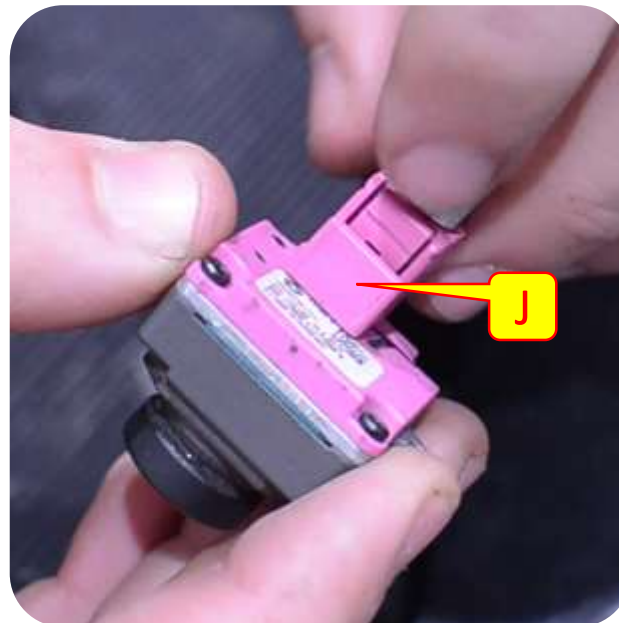

Section 3: Installation Instructions

Step 3: Backup Camera Installation

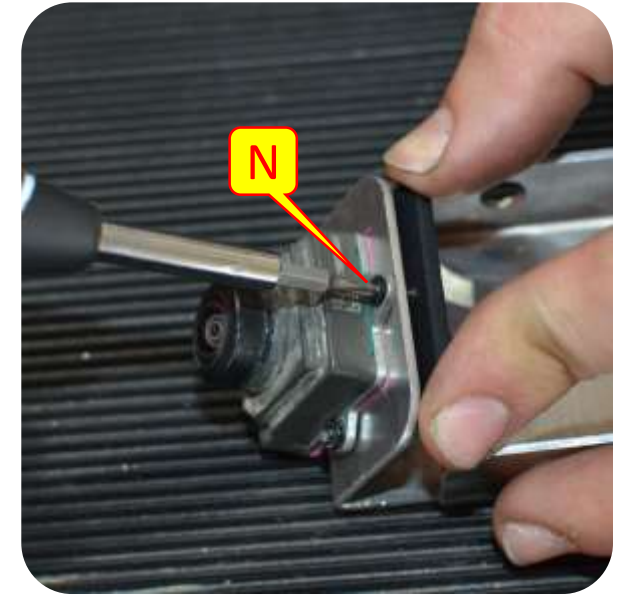
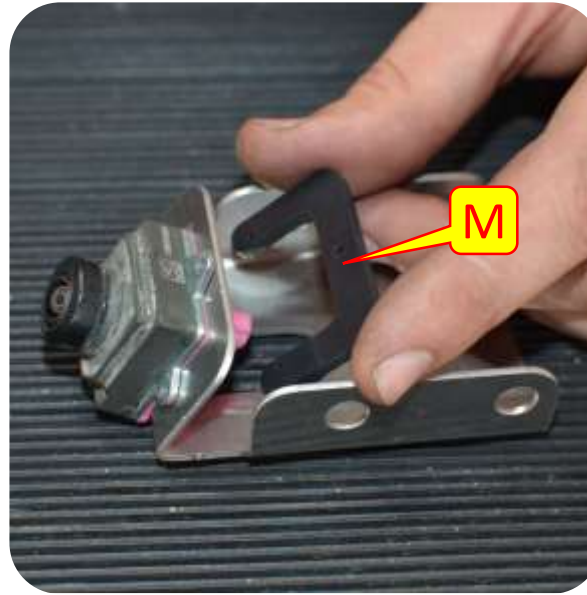
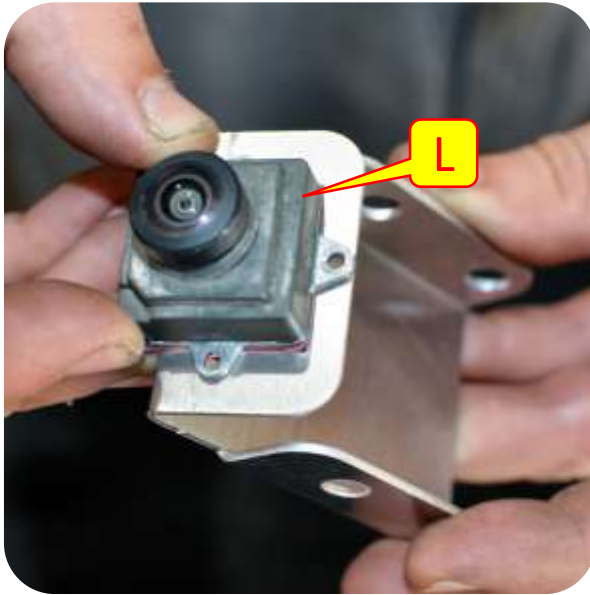

- L. Place the back up camera on the outside of the provided camera mount.
- M. Install the provided camera backing to the inside of the camera mount.
- N. Using a T8 torx wrench install the stock camera screws to the new camera mount and camera backing. Tighten fully.
- O. We will be disconnecting the tail gate hinge bolts. Use tape to help hold the tailgate in alignment.



Section 3: Installation Instructions

Step 4: SportGate Tire Carrier Installation

- P. Using a T55 torx wrench remove the stock hinge bolts. **DO NOT OPEN TAIL GATE.**
- Q. Install the split washer onto the provided hinge bolts and using a 5/16 allen tighten the new hinge bolts to the tail gate.
- R. Using a 13mm socket install the provided bolts into the stock tire carrier mount locations.

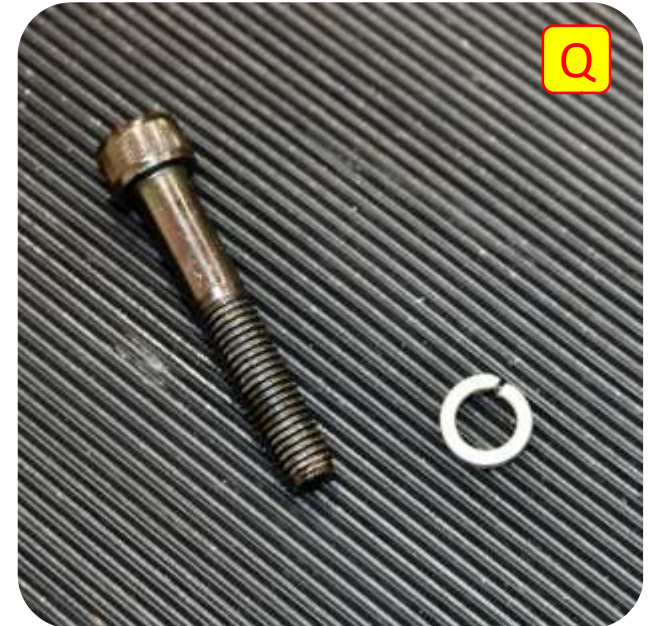

Section 2: Installation Instructions

Step 5: Press in Wheel Stud

- S. To press the wheel stud into place. Place the wheel stud into the Adjustment bracket in the chosen wheelbase location.
- T. Place a long socket on the other end of the adjustment bracket. Make sure the socket has enough room for the wheel stud to be pressed in fully.
- U. Place the wheel stud and socket inside a vice and tighten the vice until the wheel stud is completely pressed in. repeat process for remaining wheel studs.

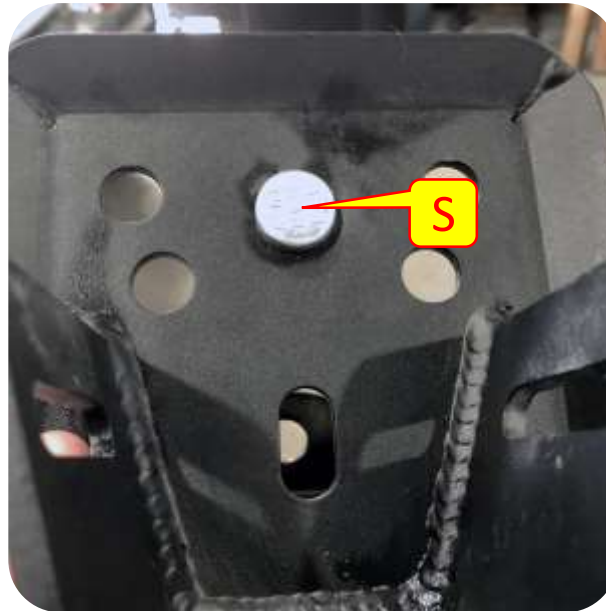

Section 3: Installation Instructions

Step 6: SportGate Tire Carrier Bracket Installation

- V. Using a 9/16" socket install the tire carrier bracket to the appropriate height for your spare tire.
- W. Loosely install the backspacing adjustment bracket to the tire carrier bracket using the provided hardware.
- X. Reinstall the rubber grommet into the tail gate and insert the back up camera wiring into the back of the backspacing adjustment bracket.
- Y. Connect the back up camera wiring to the back up camera.
- Z. Install the back up camera into the backspacing adjustment bracket and tighten the provided hardware with a 5/32" allen wrench and a 7/16 wrench.

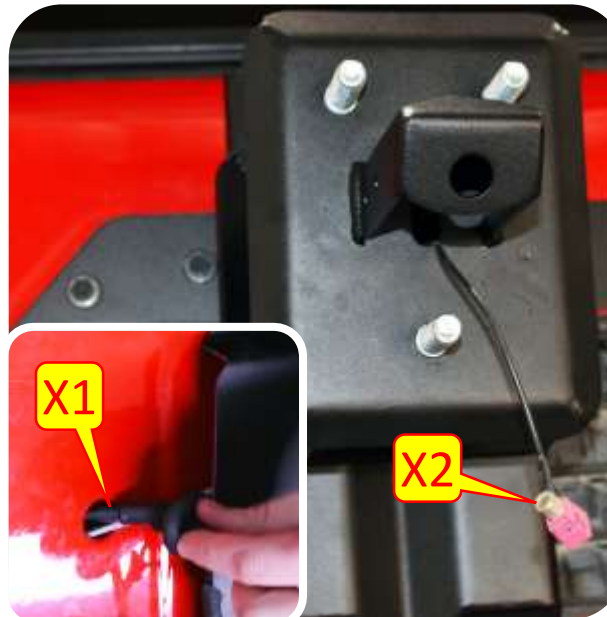
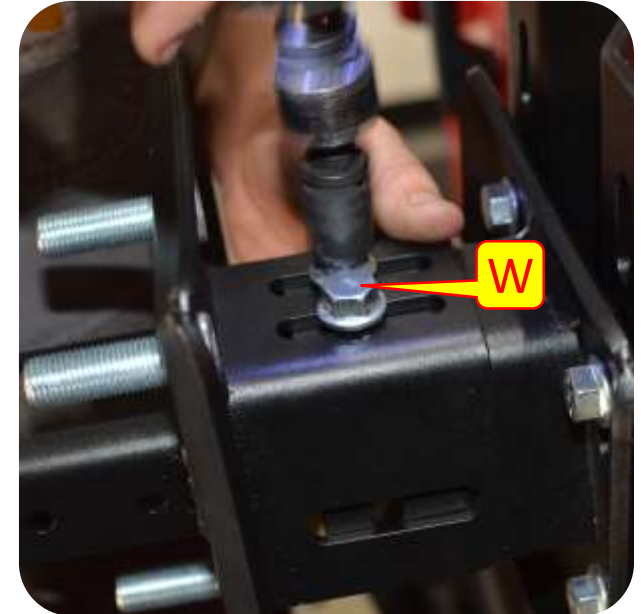
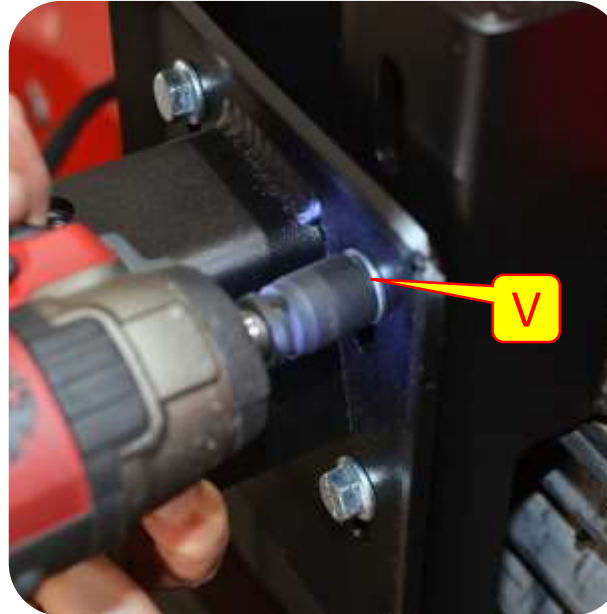

Section 3: Installation Instructions

Step 7: Spare Tire Adjustment

- AA. Install the spare tire.
- BB. Open the tailgate and tighten all hardware using a 9/16" socket while pulling the tire firmly against the tailgate.
- CC. Reconnect the back up camera clips and reinstall the tailgate plastic trim.

