



PRODUCT: JL Wrangler 4-Link Long Arm Upgrade System

REV: D | 03-22-2024 | II-7290

READ INSTRUCTIONS IN FULL BEFORE INSTALLATION.

QUESTIONS? CALL 916-631-8071 M-F 7:00 AM – 5:00 PM PST

The MetalCloak experience includes the ease of installation of our products. We design for most contingencies, but installation may be different based on different Jeep condition, configuration and/or year.

We are continually trying to improve our products and instructions – please help us by providing feedback and pictures if you find any part of the instructions that do not match your particular Jeep or are not easily understandable.

If you have any difficulties at all, please give us a call. Thank you and enjoy your MetalCloak Products!

IMPORTANT NOTE: We use Stainless Steel Hardware where possible. Therefore, a tube of Silver Anti-seize is provided and should be used on all bolts—only a small amount is needed.

WARRANTY INFORMATION: This article is sold without warranty expressed or implied. No warranty or representation is made as to this products ability to protect the user from injury or death. The user assumes that risk. The effectiveness, warranty and longevity of this equipment are directly related to the manner in which it is INSTALLED, USED and/or MAINTAINED. THE USER ASSUMES ALL RISK. By purchasing this product and opening the packaging, purchasers expressly acknowledge, understand and agree that they take, select and purchase these MetalCloak products from Armored Works, LLC, its affiliates and distributors and agents as is and with all faults. The entire risk as to the quality and performance of these MetalCloak products is with the purchaser. Working on your vehicle can be a dangerous activity. If you are unsure of what you are doing, please leave mechanical or safety critical work to a skilled mechanic. We take no responsibility for the incorrect use and/or installation of MetalCloak products.

Section 1: Tools & Notes on Installation

Tools Required: This list is the recommended tools for ease of installation. Other versions of the same tool can be used. For example, Allen Wrenches instead of Allen Drive Sockets.



Socket & Ratchet Wrench

7MM, 10MM, 13MM Sockets
18MM, 21MM, 24MM Sockets
9/16" , 13/16", 15/16" Sockets
3/4", 1 1/8" Socket



Drill
Drill Bits (1/8" up to 1/2")

15/16" Wrench 18MM Wrench
21MM Wrench 24MM Wrench



Center Punch

Tape Measure



Cut-Off Disc and Grinder

5/16" Allen Wrench



HOW TO USE THIS GUIDE: The installation guide contains ALL steps for installation. Please read and follow the instructions in order of each page top to bottom, and left to right.

Jeep Model: Instructions may apply to multiple Jeep models, but are labeled separately where appropriate (i.e. TJ vs. LJ).

Options: Because of the number of component options we offer, these instructions may contain steps that will not match your particular configuration. You can skip these steps.

Images: Pictures are provided and parts are labeled throughout the instructions. Each text box contains guidance based on the pictures next to it. The text will refer to alphabetical labels (A, B, etc.) found in the images.

Installation Notes: Terms may be used in the body of the instructions that you may not be familiar with, if you have any questions feel free to contact us at the number below, or email techhelp@metalcloak.com

QUESTIONS: Any questions or comments about the instructions? Call us at 916-631-8071 M-F 7:00 AM – 5:00 PM PST.

Section 2: Product Components

DC-0001 Rev B

SHEET 1 OF 1

ITEM.	PART NUMBER / DESCRIPTION	QTY.
1	6361 SKID PLATE SYSTEM UPGRADED CROSS-MEMBER, JLU JT	1
2	7291 4-LINK LONG-ARM PAIR, UPPER FRONT JK JL JT	1
3	7293 4-LINK LONG-ARM SET, REAR UPPER JK-JL	1
4	7294 4-LINK LONG-ARM PAIR, REAR LOWER JK-JL	1
5	7295 LONG ARM MOUNT LOWER, FRONT JL-JT	1
6	7297 4-LINK LONG-ARM PAIR, LOWER FRONT JL JT	1
7	7298 4-LINK MOUNT UPPER, FRONT JL JT	1
8	7299 4-LINK MOUNT, REAR JL	1

THE INFORMATION CONTAINED ON THIS DRAWING IS THE EXCLUSIVE PROPERTY OF ARMORED WORKS, LLC. UNAUTHORIZED REPRODUCTION IS PROHIBITED.
DO NOT SCALE DRAWING

METAL CLOAK
 A DIVISION OF ARMORED WORKS, LLC

PART NUMBER/DESCRIPTION 7290 BOLT ON 4 LINK FULL SYSTEM, JLU

Section 2: Product Components

ITEM.	PART NUMBER	QTY.
1	WM-5885 WELDMENT, .5-13 FLAG NUT	2
2	WM-5896 WELDMENT, FLAG NUT .5-20, 4-LINK MOUNT JK JL	2
3	WM-5901 WELDMENT, FRONT NUT PLATE, 4-LINK MOUNT JL JT	1
4	WM-5901-P WELDMENT, FRONT NUT PLATE, 4-LINK MOUNT JL JT	1
5	WM-5955 WELDMENT, 4-LINK MOUNT UPPER, FRONT JL JT	1
6	WM-5955-P WELDMENT, 4-LINK MOUNT UPPER, FRONT JL JT	1
7	WM-5958 WELDMENT, LONG FLAG NUT 5-13, LONG ARM MOUNT JL JT	2
HK-7298		
8	FS-08173 HHCS, 0.5-13 x 1.75L STL G8 ZINC FULL THREAD	8
9	FS-08307 WASHER, 0.53ID X 1.06OD X 0.20TH STL GR8 GOLD ZINC	12
10	FS-08311 HHCS, 0.5-20 x 3.00L STL G8 ZINC	2
11	FM-12350 HHCS, M12-1.5 X 35L STL C10.9 GOLD ZINC	2

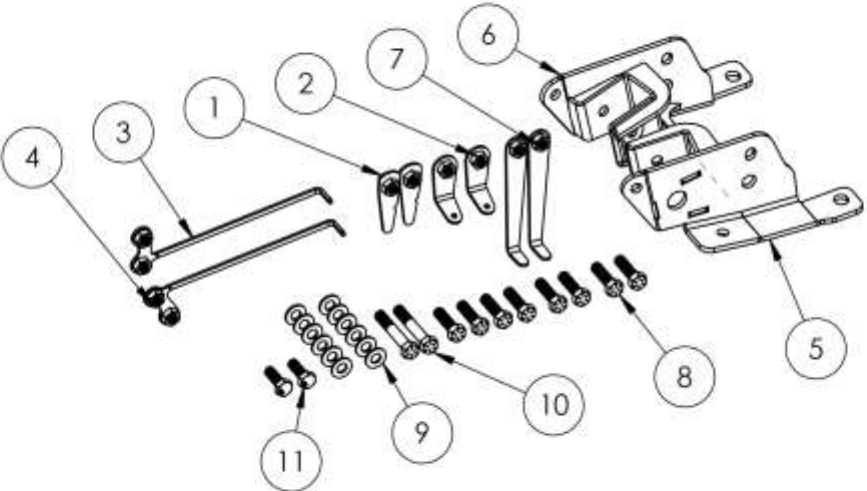

THE INFORMATION CONTAINED ON THIS DRAWING IS THE EXCLUSIVE PROPERTY OF ARMORED WORKS, LLC. UNAUTHORIZED REPRODUCTION IS PROHIBITED.

DO NOT SCALE DRAWING

PART NUMBER/DESCRIPTION



Metal Cloak
A DIVISION OF ARMORED WORKS, LLC

7298 4-LINK MOUNT UPPER, FRONT JL JT

Section 2: Product Components

DC-0001 Rev B

SHEET 1 OF 2

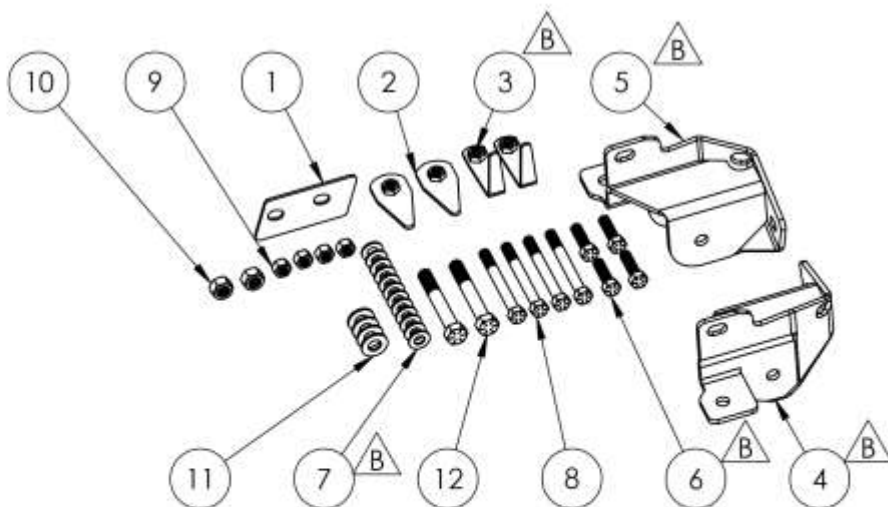
ITEM.	PART NUMBER / DISCRIPTION	QTY.
E	1 SS-0325 BACKING PLATE, LONG-ARM MOUNT LOWER, FRONT JL JT	1
	2 WM-5897 WELDMENT, FLAG NUT .5-13, LOWER LONG-ARM MOUNT JL JT	2
	3 WM-5898 WELDMENT, FLAG NUT 5-13, LONG ARM MOUNT JL JT	2
	4 WM-5954 WELDMENT, LONG-ARM MOUNT LOWER, FRONT JL JT	1
	5 WM-5954-P WELDMENT, LONG-ARM MOUNT LOWER, FRONT JL JT	1
HK-7295		
D	6 FS-08173 HHCS, 0.5-13 x 1.75L STL G8 ZINC FULL THREAD	4
	7 FS-08307 WASHER, 0.53ID X 1.06OD X 0.20TH STL GR8 GOLD ZINC	12
	8 FS-08322 HHCS, 0.50-13 x 4.50L STL G8 GOLD ZINC	4
	9 FS-08359 TOPLOCK NUT, 0.5-13 X .44H STL GC STL ZINC	4
	10 FS-10130 TOPLOCK NUT, 0.63-18 X 0.55H STL GC CAD	2
	11 FS-10161 WASHER, 0.66ID X 1.31OD X 0.14TH STL GR8 GOLD ZINC	4
	12 FS-10295 HHCS, 0.63-18 X 4.25L STL G8 ZINC	2
		
<p>THE INFORMATION CONTAINED ON THIS DRAWING IS THE EXCLUSIVE PROPERTY OF ARMORED WORKS, LLC. UNAUTHORIZED REPRODUCTION IS PROHIBITED.</p> <p>DO NOT SCALE DRAWING</p> <p>PART NUMBER/DESCRIPTION 7295 LONG ARM MOUNT LOWER, FRONT JL-JT</p>		

Section 2: Product Components



ITEM NO.	PART NUMBER	QTY.
1	SS-0289 SIDE SHIM PLATE, 4-LINK MOUNT, REAR JK-JL	1
2	SS-0289-P SIDE SHIM PLATE, 4-LINK MOUNT, REAR JK-JL	1
3	SS-0290 BOTTOM SHIM PLATE, 4-LINK MOUNT, REAR JK-JL	2
4	SS-0312 THREADED FRAME INSERT, 4-LINK MOUNT, REAR JL	2
5	WM-5890 WELDMENT, 4-LINK MOUNT, REAR JK-JL	1
6	WM-5890-P WELDMENT, 4-LINK MOUNT, REAR JK-JL	1
7	WM-5950 WELDMENT, SIDE STICK NUT, 4-LINK MOUNT JL	2
8	WM-5951 WELDMENT, BOTTOM STICK NUT, 4-LINK MOUNT JL	2
9	WM-5956 WELDMENT, LARGE FRAME PLATE, 4-LINK MOUNT REAR JL	1
10	WM-5956-P WELDMENT, LARGE FRAME PLATE, 4-LINK MOUNT REAR JL	1
11	WM-5957 WELDMENT, SMALL FRAME PLATE, 4-LINK MOUNT, REAR JL	1
12	WM-5957-P WELDMENT, SMALL FRAME PLATE, 4-LINK MOUNT, REAR JL	1
HK-7299		
13	FM-12350 HHCS, M12-1.5 X 35L STL C10.9 GOLD ZINC	2
14	FS-06015 HHCS, 0.38-16 x 1.5L STL G8 ZINC, FULL THREAD	4
15	FS-06142 WASHER, 0.41ID X 1.0OD X 0.09TH STL ZINC	4
16	FS-08083 SFHCS, 0.5-13 X 1.00L STL G8 ZINC	2
17	FS-08173 HHCS, 0.5-13 x 1.75L STL G8 ZINC FULL THREAD	8
18	FS-08307 WASHER, 0.53ID X 1.06OD X 0.20TH STL GR8 GOLD ZINC	10
19	FS-09119 WASHER, 0.59ID X 1.16OD X 0.10TH STL GOLD ZINC	8
20	FS-09305 TOPLOCK NUT, 0.56-18 X .48H STL GC STL ZINC	4
21	FS-09313 HHCS, 0.56-18 X 4.0L STL GOLD ZINC	4

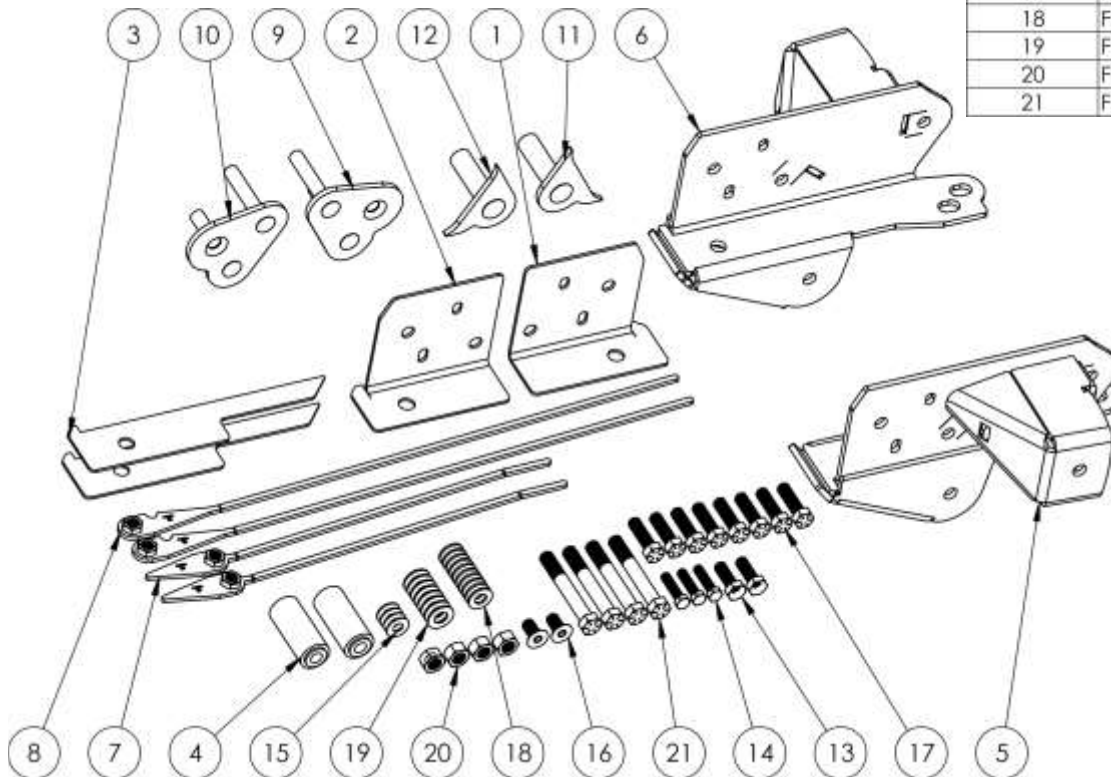

Section 3: Installation Instructions



Step 1: Install MetalCloak Crossmember

Note: Before removing the crossmember support the transmission and transfer case with jackstands.

- A. Remove the factory cross member and install the provided MetalCloak cross member using 21mm socket at the transmission mount, a 13mm socket for the exhaust mount and 18mm socket and wrench for the crossmember.

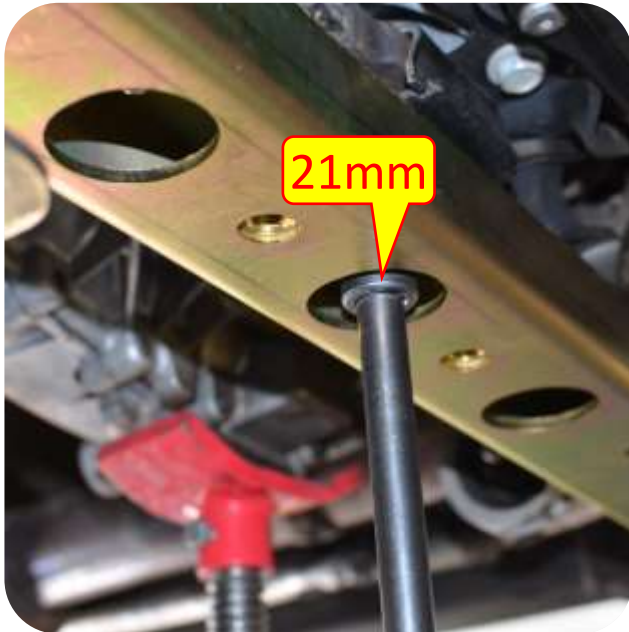

Section 3: Installation Instructions

Step 2: Disconnect Front Control Arms (*Stock Control Arms*)

Note: Make sure to use jack stands to support the axle before removing the control arms.

Note: The brake line on the lower front control arms (drivers and passenger side) must be removed from the bracket. It may be pried out or cut; be VERY careful not to damage the brake line!!!

Note: On the passenger side upper control arm you will need to cut the stock bolt as the exhaust interferes with the bolt removal.

- B. Disconnect the upper control arm heat shield on both sides at the frame using a 10MM Socket. Save heat shields and all hardware.
- C. Use a 24mm Socket & Wrench to remove the stock bolts from the front lower control arms. **Save all hardware.**
- D. Using a 18mm wrench and socket remove the Front Upper Control Arms. **Save all hardware.**

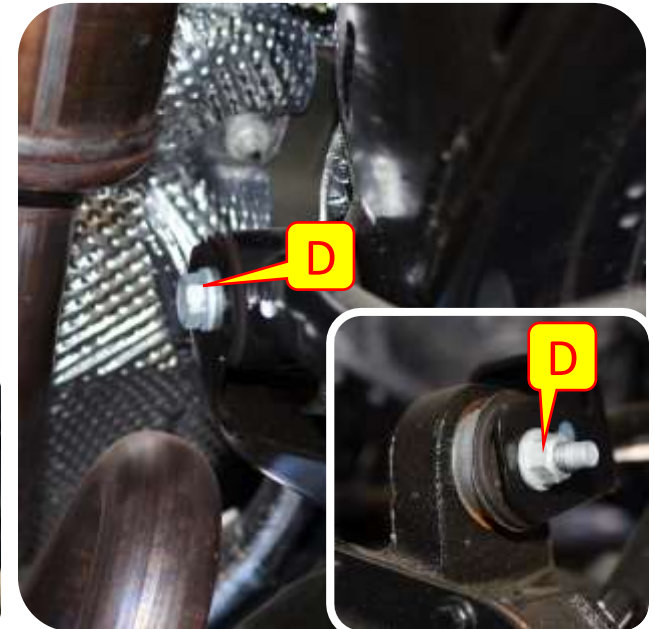
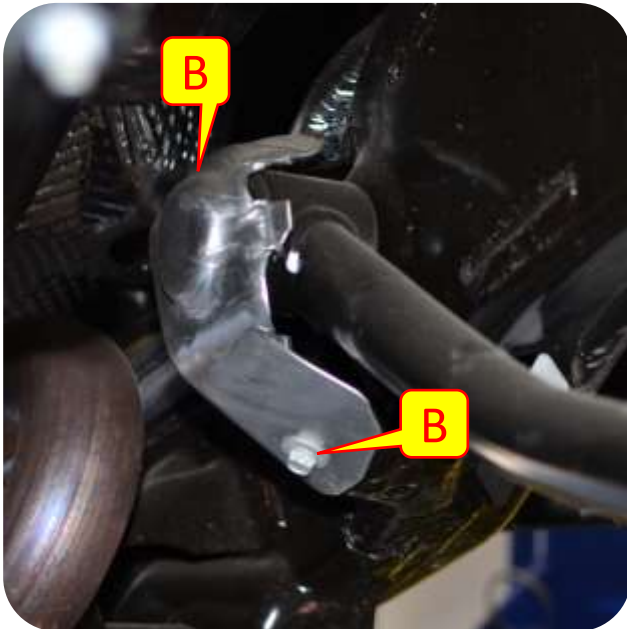

Section 3: Installation Instructions



Step 2: Disconnect Front Control Arms (*MetalCloak Mid Arms*)

Note: Make sure to use jack stands to support the axle before removing the control arms.

- E. Disconnect the front lower control arms using a 24mm socket & wrench. **Save Hardware.**
- F. Disconnect the front upper control arms using a 18mm socket and wrench. **Save Hardware.**

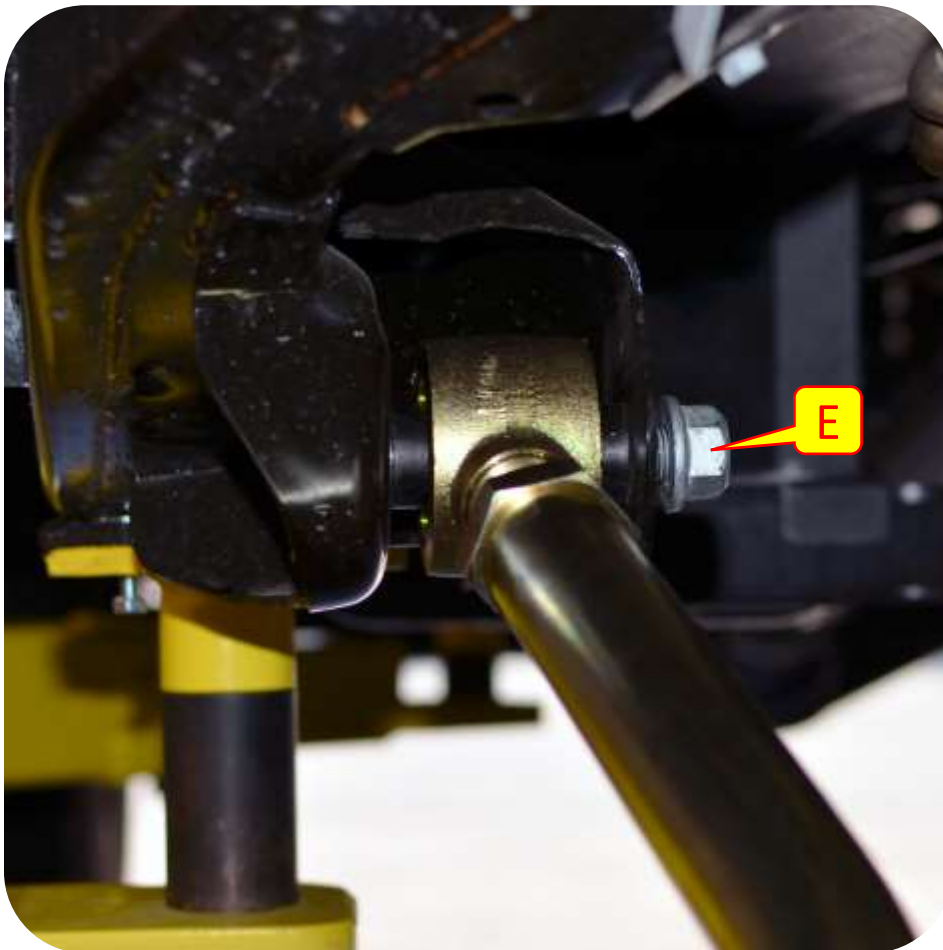

Section 3: Installation Instructions

Step 3: Removing Stock Control Arm Mounts

- G. Using a cut off wheel & grinder or torch remove the factory front control arm brackets from the frame.
- H. Clean and paint any exposed metal to prevent rust.

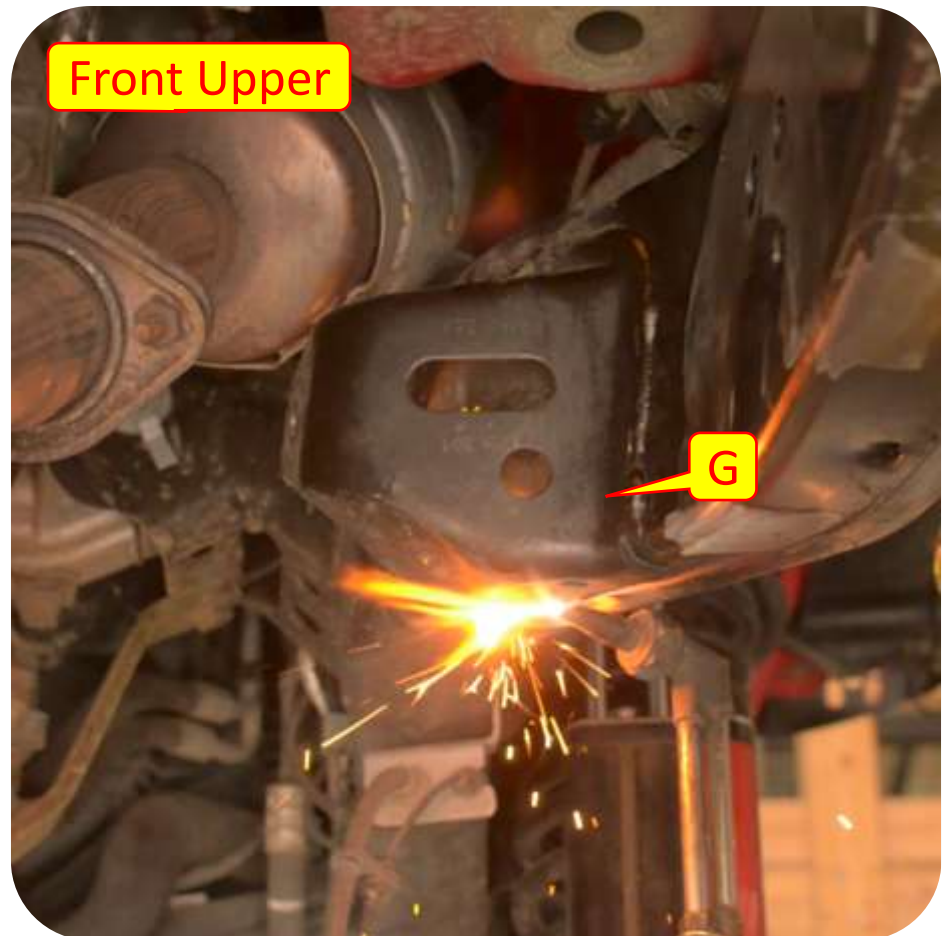
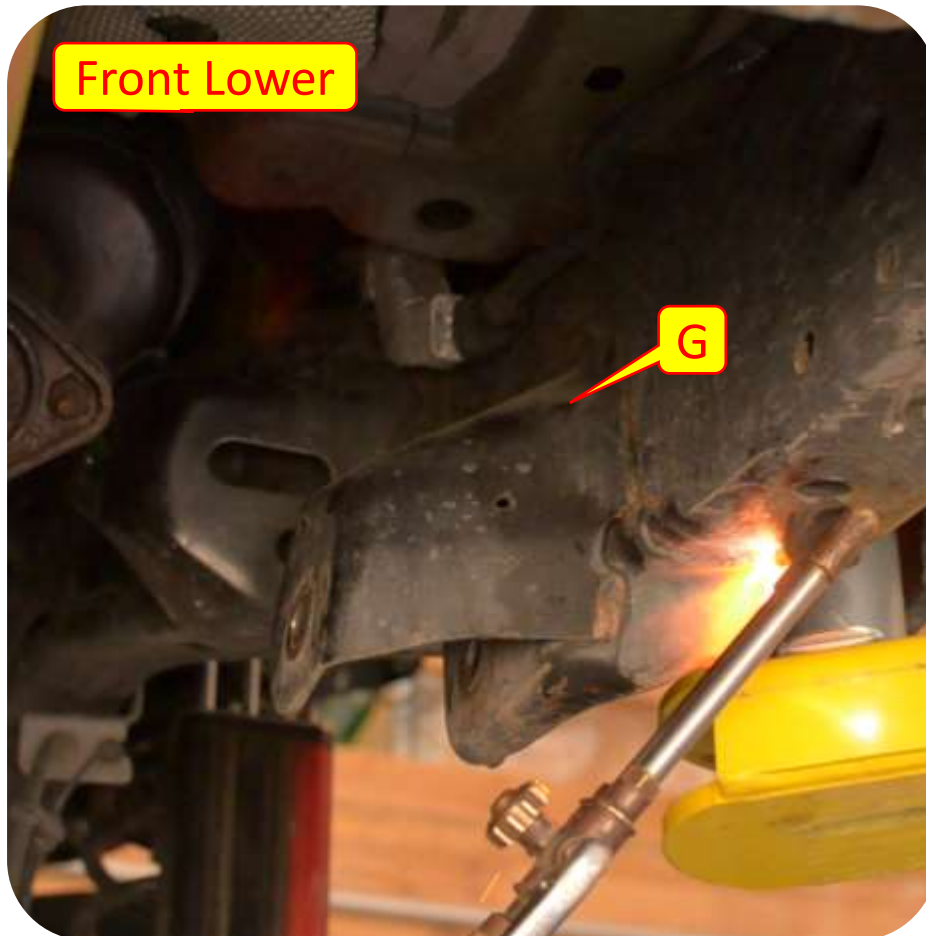

Section 3: Installation Instructions

Step 4: Install the Front Lower Control Arm Bracket

- I. Install the lower control arm bracket to the crossmember using the provided 1/2" bolts (3/4" head), washers and nuts and hand tighten.

Note: *The passenger side lower control arm bracket comes with a shim to be placed between the bracket and the crossmember. If you have a symmetric crossmember (w/6391) on your gladiator; do not use the provided shim.*

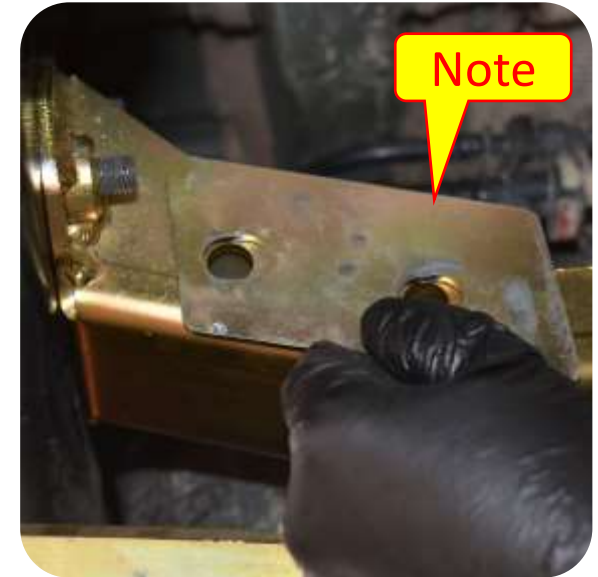

Section 3: Installation Instructions

Step 4: Install the Front Lower Control Arm Bracket

J. Insert flag nut (*BOM#3*) into the frame and install 3/4" bolt and washer through the control arm bracket at the bottom of the frame.

K. Insert flag nut (*BOM#4*) into the side of the frame and install 3/4" bolt through control arm bracket and frame.

L. Tighten all lower control arm bracket hardware.

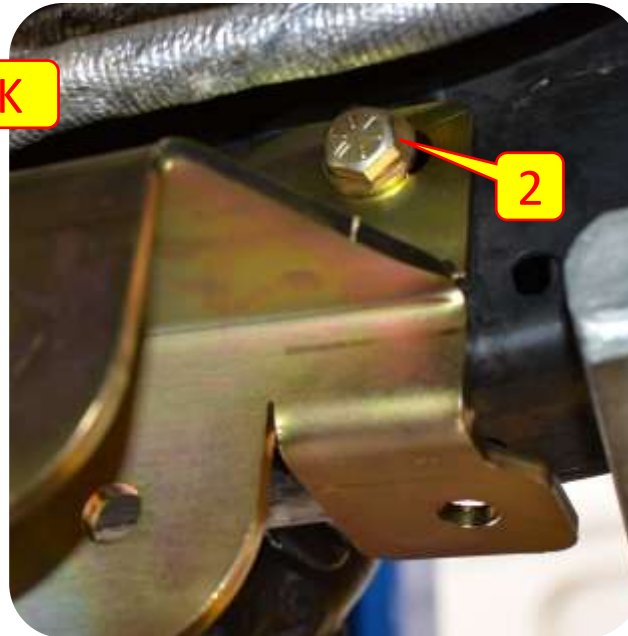
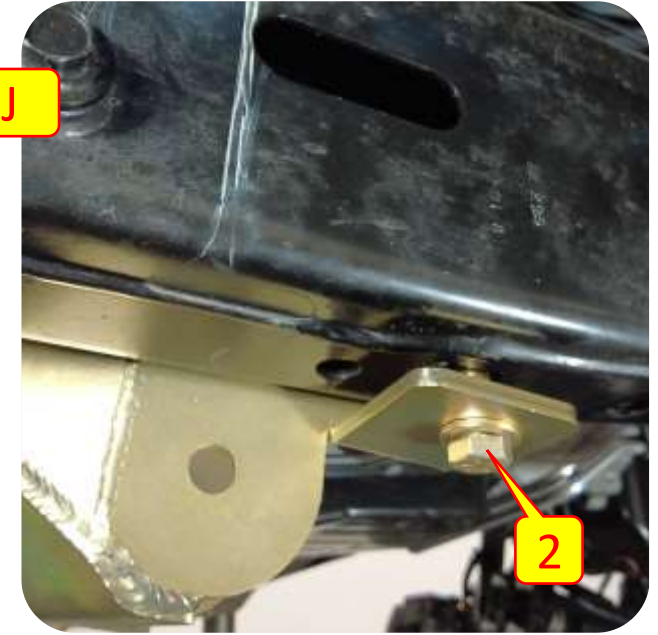

Section 3: Installation Instructions

Step 5: Install the Front Upper Control Arm Bracket

- M. Place upper control are bracket up to frame and align rear most slot on the bottom of the bracket with factory threaded insert using the provided 18mm head 12mm bolt. Insert the bolt and snug holding the bracket with pressure to the rear of the vehicle.
- N. Use a jack or c clamp to pull the rest of the bracket tight up to the vehicles frame.
- O. Mark the 1 hole on the bracket for drilling.

Note: *If your vehicle is equipped with the factory crash bar on the passenger side frame rail, trace the profile of the lower large hole just rear of the arm pocket.*

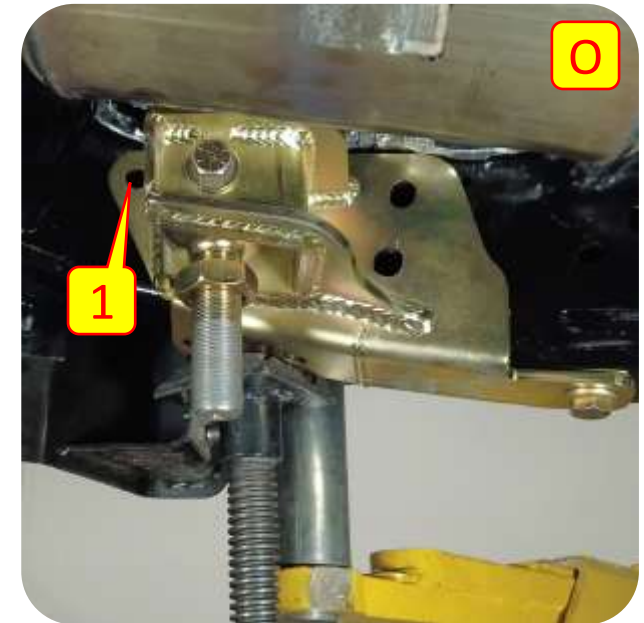
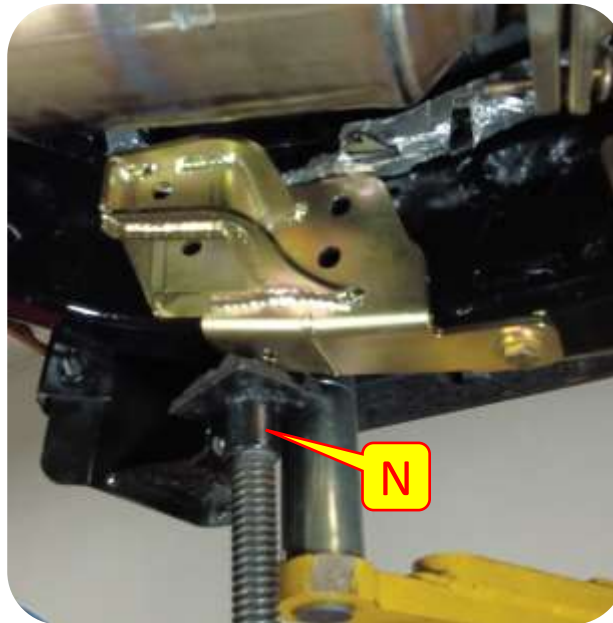

Section 3: Installation Instructions

Step 5: Install the Front Upper Control Arm Bracket

- P. Remove the bracket and drill you 2x 1/2 holes and if equipped with the crash bar clearance the marked hole using a die girder or something similar.
- Q. Place upper control are bracket up to frame and align rear most slot on the bottom of the bracket with factory threaded insert using the provided 18mm head 12mm bolt. Insert the bolt and snug holding the bracket with pressure to the rear of the vehicle.
- R. Use a jack or c clamp to pull the rest of the bracket tight up to the vehicles frame.

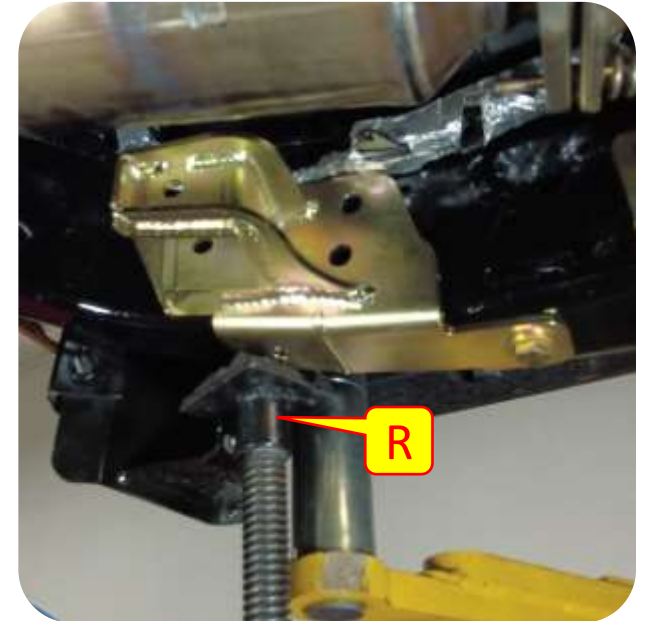
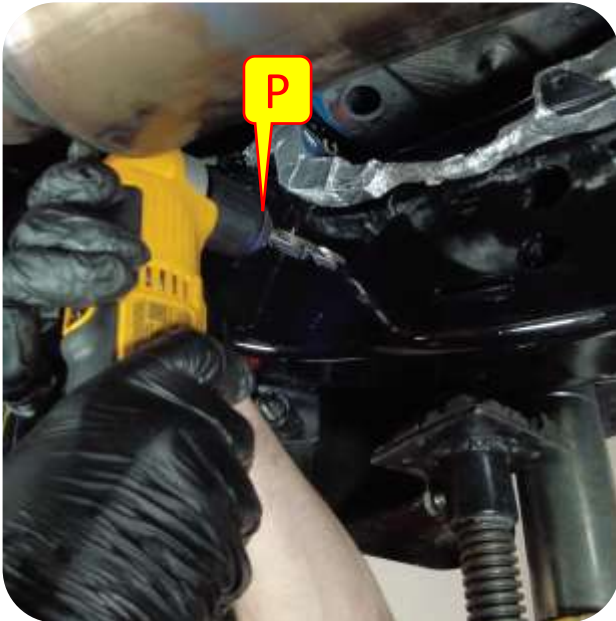

Section 3: Installation Instructions

Step 5: Install the Front Upper Control Arm Bracket

- S. Insert flag nut BOM #3 into the same slot as step K. Align with the 2 holes on the rear side of the bracket and install the two provided 3/4" head 1/2" bolts into this flag plate.
- T. Insert flag nut BOM #7 into the hole in the frame just ahead of the body mount and align with the hole on the inside from most hole drilled earlier. install provided bolt.



Section 3: Installation Instructions

Step 5: Install the Front Upper Control Arm Bracket

- U. Using a 1/2" drill bit drill out the lower front hole on the frame.
- V. Insert the flag nut BOM #1 into the hole in the side of the frame between the mounts and install the provided bolt into the front most bottom hole drilled out in step U.

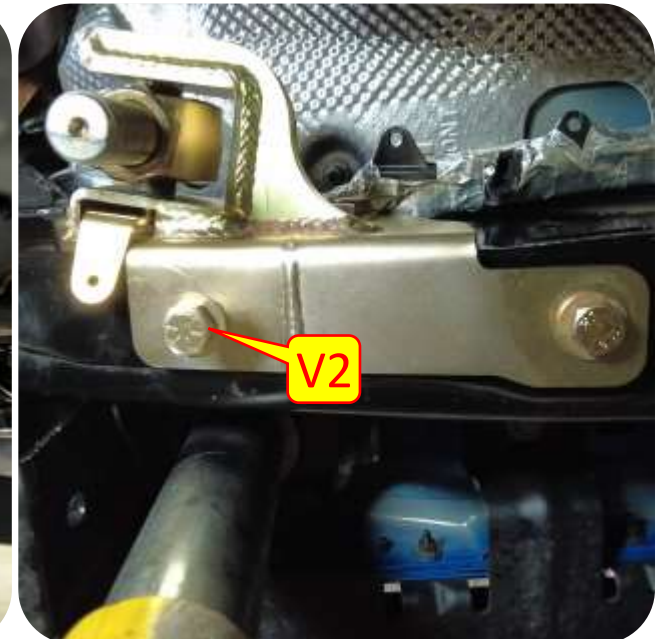

Section 3: Installation Instructions

Step 6: Install the Front Control Arms

Note: Measure the upper front control arms to 26 3/4" eye to eye and the lower rear control arms to 37 9/16" eye to eye. These control arm specifications are just starting points. **ALL JEEPS ARE DIFFERENT.** MetalCloak recommends seeing a suspension specialist for correct control arm lengths for **YOUR** Jeep.

- W. Install the front upper control arm into the upper control arm bracket loosely using the provided 1/2" bolt and flag nut (BOM#3 & BOM#11).
- X. Install the lower control arm into the axle and bracket at the crossmember using a 13/16" socket at the frame and the factory 21mm bolt at the axle.
- Y. Set the caster and install the upper control arms at the axle end using the factory hardware.

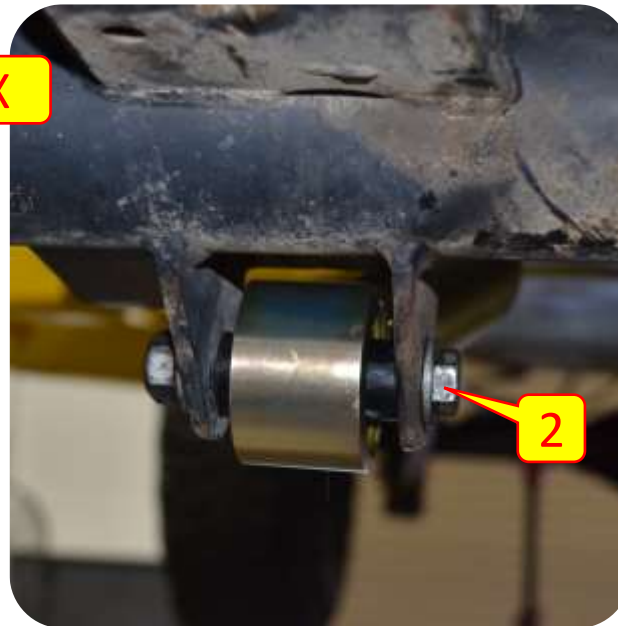
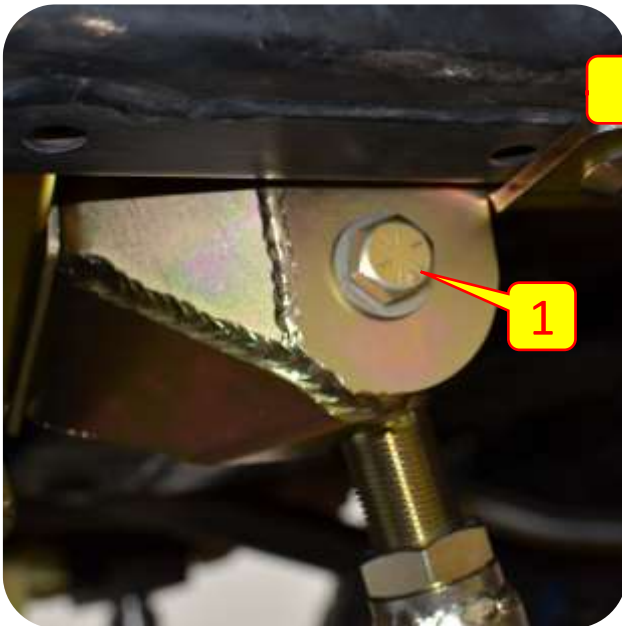
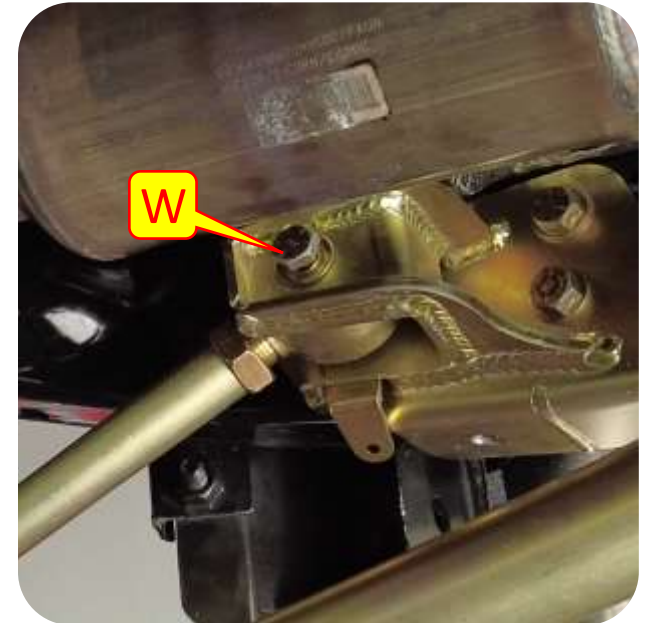

Section 3: Installation Instructions

Step 1: Remove Gas Tank

- A. Place a jack or something similar under the gas tank to support it.
- B. Remove all the bolts holding the gas tank in place with a 18mm socket.
- C. Remove the gas fill neck by loosening the hose clamp using a 7mm socket or wench.

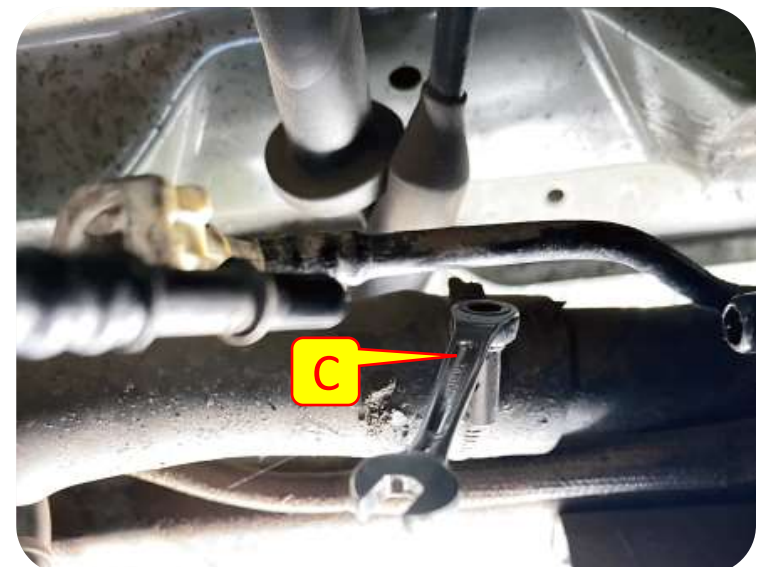
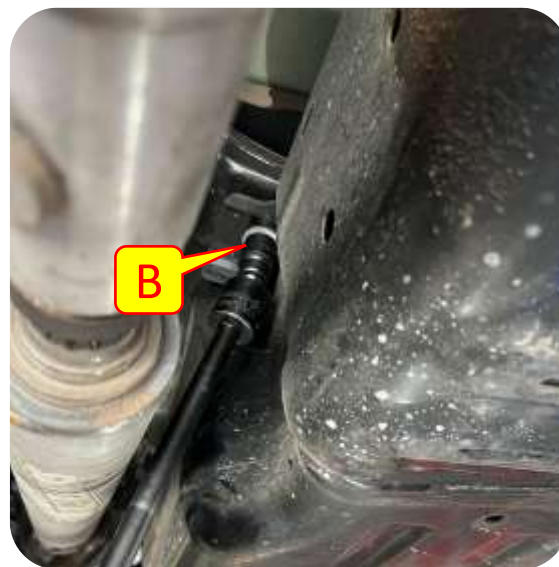
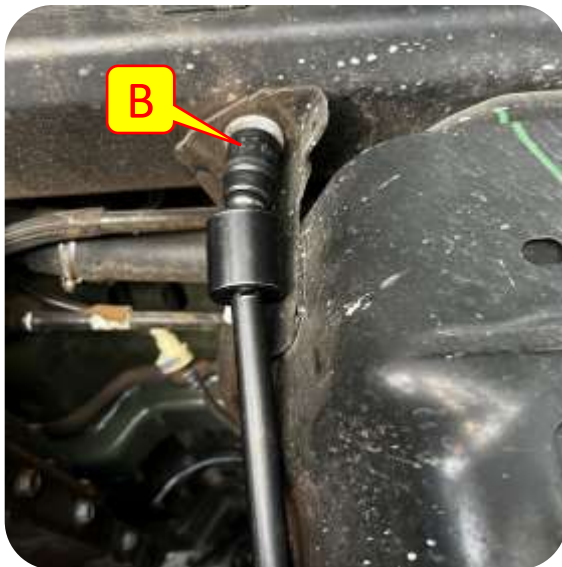

Section 3: Installation Instructions

Step 1: Remove Gas Tank

- D. Remove filler breather by removing the plastic retaining clip before pressing on the line fitting. ****be careful not to break as they are not very strong****
- E. Remove any plastic "Christmas trees" that may be connecting the fuel line to the gas tank.
- F. Remove the fuel lines in front of the gas tank by removing plastic retaining clip before pressing down on the line fitting. ****Be careful as these lines may be under pressure and release fuel. We recommend using a container to catch any released fuel to prevent mess.****

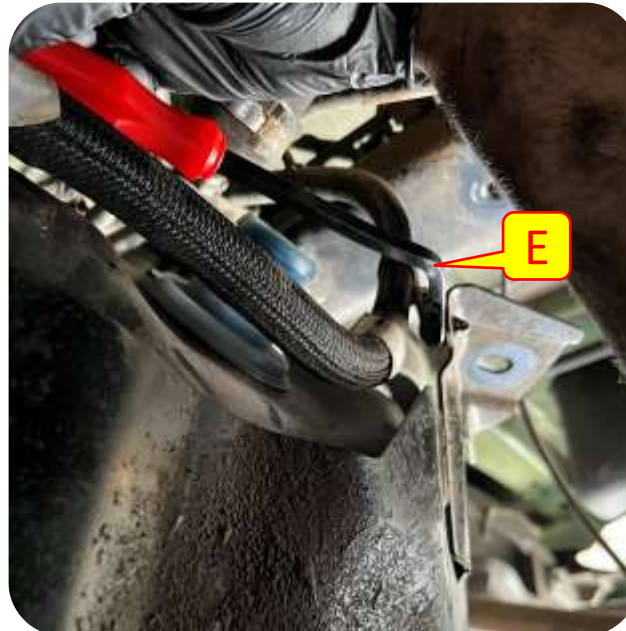

Section 3: Installation Instructions

Step 1: Remove Gas Tank

- G. Remove evap canister hoses by pressing on the line fittings.
- H. Remove the gas tank.

Important Note: Move the gas tank at least 25 ft away and make sure the room is well vented as we will be drilling and grinding.



Section 3: Installation Instructions

Step 2: Rear Control Arm Bolt On Bracket Installation

- I. Support the rear axle with jack stands and remove the rear control arms using a 21mm socket and wrench.
- J. Using a cut off wheel/grinder or torch; remove the existing rear control arm brackets from the frame, clean the frame and paint the left-over exposed metal.
- K. Make sure to grind down the factory weld spatter on each side of the frame so it is flush and paint the exposed metal to prevent rust

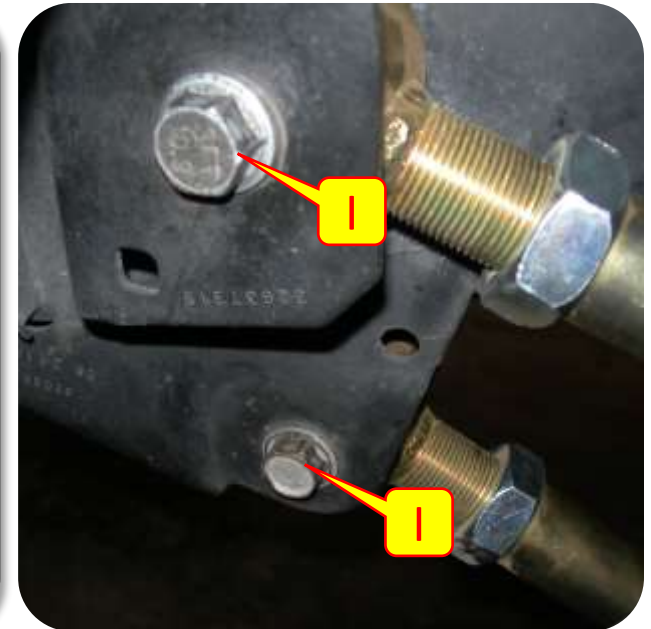

Section 3: Installation Instructions

Step 2: Rear Control Arm Bolt On Bracket Installation

- L. Thread in the tapered flat head bolt into the threaded frame insert as shown, this will help prevent losing it inside the frame by accident.
- M. Insert the spacer through the outer part of the frame as shown.
- N. Once the space is lined up, remove the hardware and place the large frame plate onto the frame, then reinstall the 5/16 allen flat head bolt.
- O. Install the small frame plate.

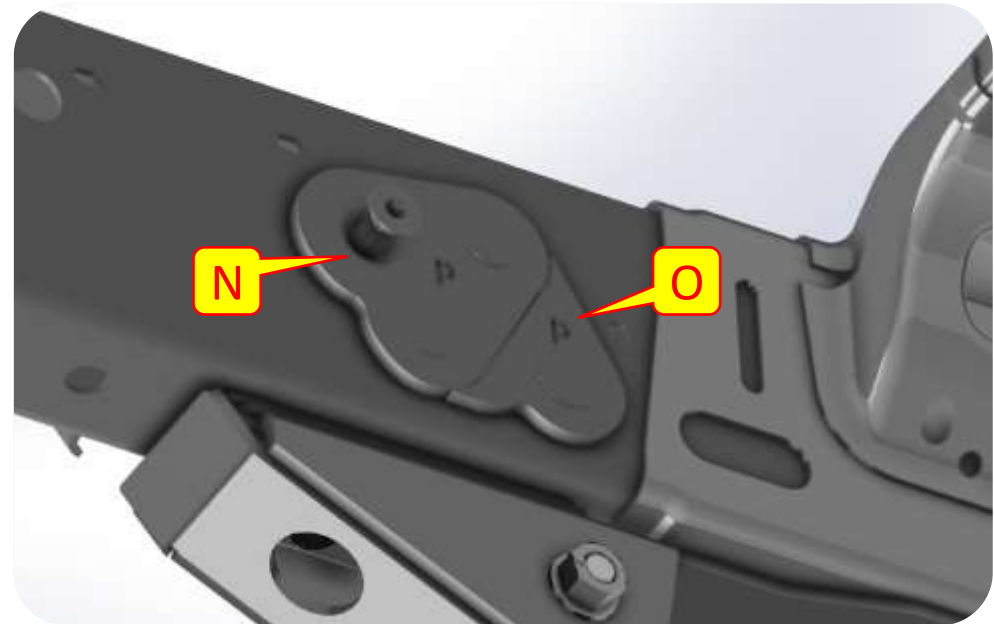

Section 3: Installation Instructions

Step 2: Rear Control Arm Bolt On Bracket Installation

P. Place the control arm bracket shims into the inside of the rear control arm bracket.

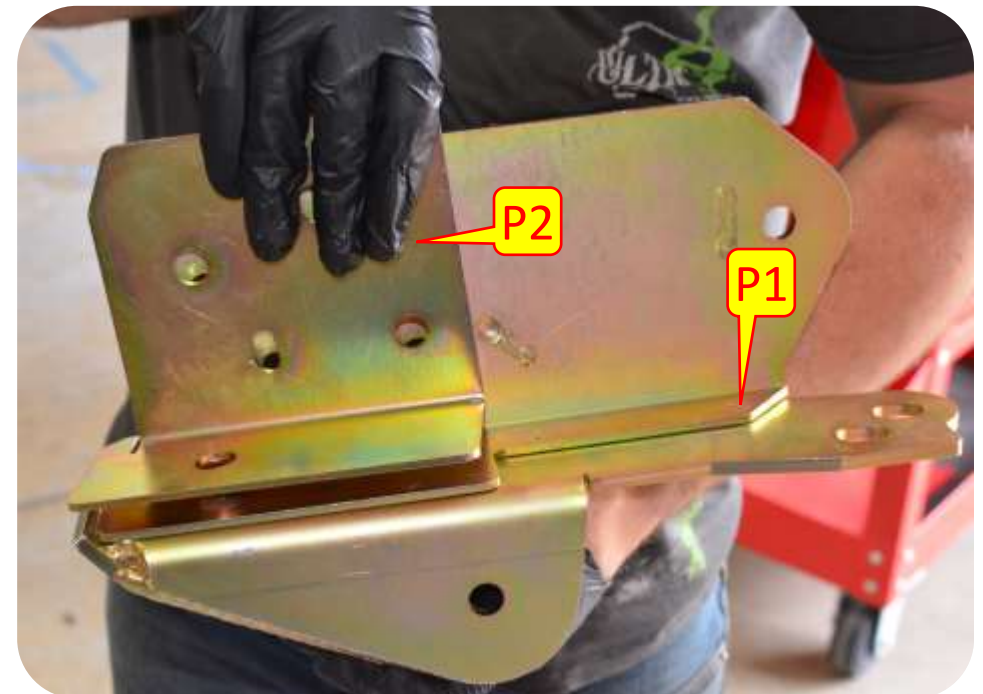

Section 3: Installation Instructions

Step 2: Rear Control Arm Bolt On Bracket Installation

- Q. Place the long arm bracket onto the frame and install the provided 1/2 bolts (3/4" heads). We recommend using a floor jack or clamp to hold the bracket tight to the frame.
- R. Install provided 12mm bolts (18mm bolt head) hardware into the bottom of the bracket.
- S. Mark the hole location at the bottom and side of the bracket for drilling.
- T. Remove the bracket drill out the marked locations starting with a smaller drill bit, work your way up to 1/2 drill bit. We recommend painting any exposed metal to prevent rust.

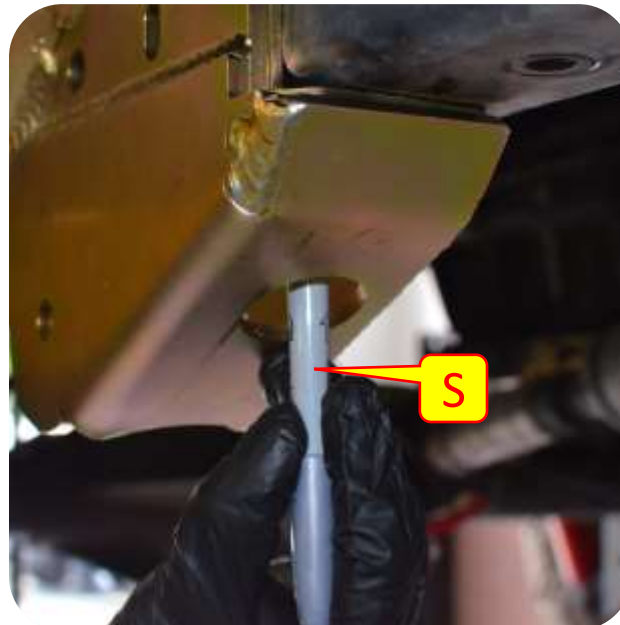
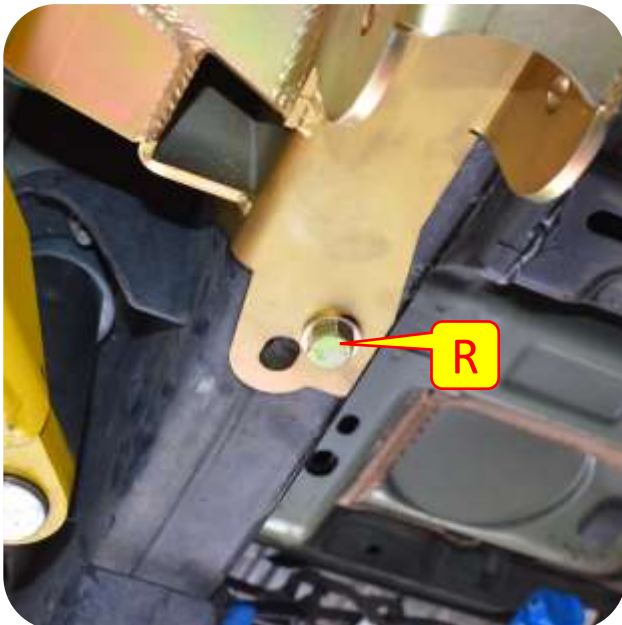

Section 3: Installation Instructions

Step 2: Rear Control Arm Bolt On Bracket Installation

- U. Reinstall the bracket with shims onto the frame, installing the 1/2" bolts (3/4" heads) and 3/8" in bolts with (9/16" heads) hardware.
- V. Insert the longer flag nut (*BOM#8*) through the hole located in the factory lower control arm mount and install the 1/2" bolt (3/4" head) hardware into the hole that was drilled in Step T.
- W. Insert the shorter flag nut (*BOM#7*) through the hole located in the factory lower control arm mount and install the 1/2" bolt (3/4" head) hardware into the hole located at the rear of the bracket.

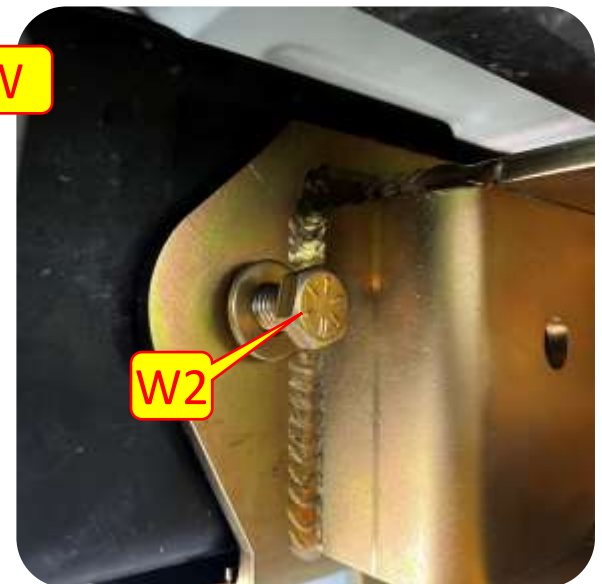
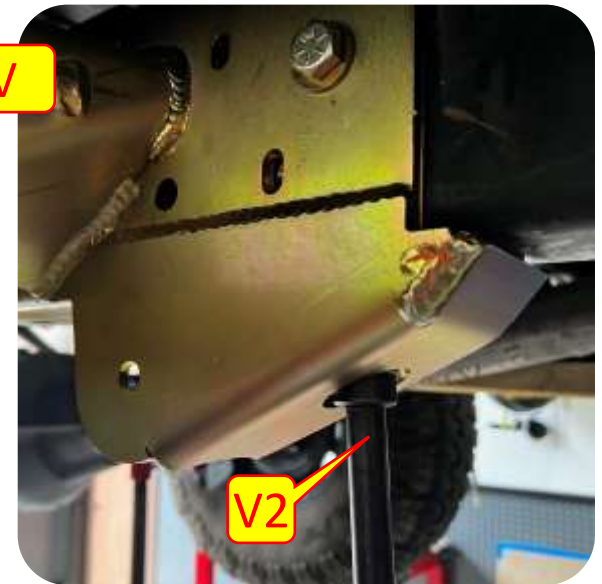

Section 3: Installation Instructions



Step 3: Gas Tank Installation

Important Note: If you're installing the rear long arm kit with our UnderCloak system. Check to see if the UnderCloak system will mount without modification. If the UnderCloak does not fit the gas tank skid plate will need to be modified, you will need to notch out the gas tank skid plate and reinstall the skid plate (See Last Page for Instructions).

Important Note 2: Cut off the last gas tank mount as shown. Make sure there is plenty of ventilation before cutting the mount off.

Important Note 3: Cut off the rear tab on the gas tank mount next to the one you removed in note 2 as shown. Make sure there is plenty of ventilation before cutting the mount off.



Section 3: Installation Instructions

Step 3: Gas Tank Installation

- X. Reinstall the gas tank.
- Y. Reinstall the fuel lines in front of the gas tank.
- Z. Reinstall any plastic "Christmas trees" that connected the fuel line to the gas tank.
- AA. Reconnect filler breather.

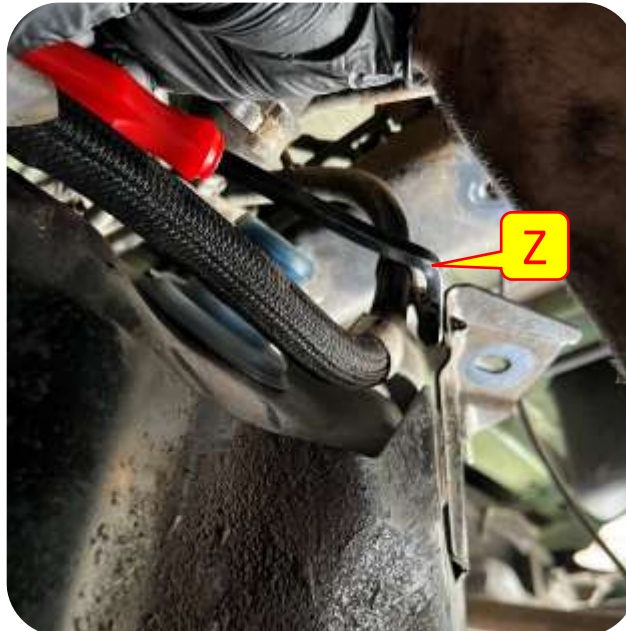

Section 3: Installation Instructions

Step 3: Gas Tank Installation

BB. Reinstall evap canister hoses.

CC. Reconnect the gas fill neck using a 7mm socket or wench.

DD. Reinstall all the gas tank bolts with a 18mm socket.

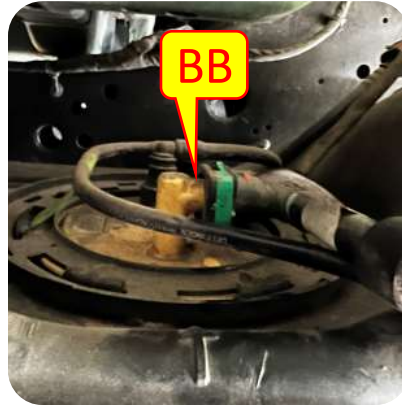

Section 3: Installation Instructions



Step 4: Rear Control Arm Installation

Note: Measure the upper rear control arms to 32 1/2" eye to eye and the lower rear control arms to 38 1/4" eye to eye. These control arm specifications are just starting points. **ALL JEEPS ARE DIFFERENT.** MetalCloak recommends seeing a suspension specialist for correct control arm lengths for **YOUR** Jeep.

- EE. Install the lower control arms orientating it so that the lock is toward the frame, using the provided 9/16" hardware and a 15/16" socket and wrench at the frame and the factory hardware using a 21mm socket and wrench at the axle end.
- FF. Install the upper control arms, orientating it so that the lock nut is toward the axle, using a 15/16" socket and wrench at the frame end and the factory hardware using a 21mm socket and wrench at the axle end.
- GG. Make sure all hardware is fully tightened.

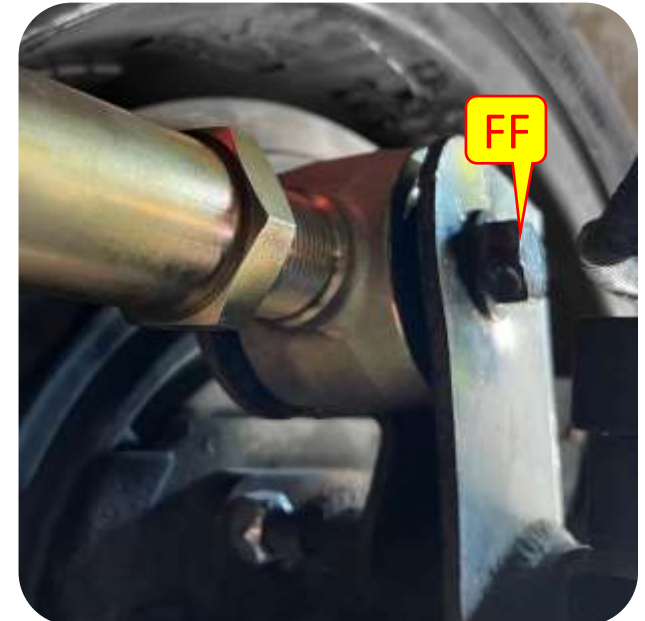
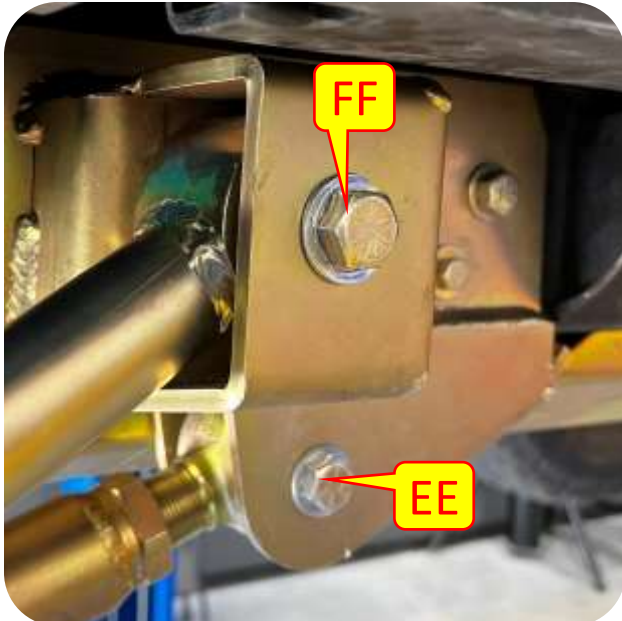

Section 3: Installation Instructions



Step 5: Modifying the UnderCloak Gas Tank Skid

The Following Step is ONLY if you have the MetalCloak UnderCloak System that needs to be modified.

To modify your UnderCloak Gas Tank Skid Plate measure 1.5" up from the bend line to the cut out for factory arms. from this point measure forward 19" in parallels to the bend line (dash line) and then up to the edge of the skid at a 135 deg angle. measure forward 14.25" and draw a circle approximately 1.5" diameter this is to clear the hardware on the long arm mount. Using a cutoff wheel cut along the line (green line). These Measurements are starting points you may need to modify your skid slightly to fit properly.

