



PRODUCT: JL/JT RockSport Steering Stabilizer Kit

REV: C | 09-28-2020 | II-7681

**READ INSTRUCTIONS IN FULL BEFORE INSTALLATION.
QUESTIONS? CALL 916-631-8071 M-F 7:00 AM – 5:00 PM PST**

The MetalCloak experience includes the ease of installation of our products. We design for most contingencies, but installation may be different based on different Jeep condition, configuration and/or year.

We are continually trying to improve our products and instructions – please help us by providing feedback and pictures if you find any part of the instructions that do not match your particular Jeep or are not easily understandable.

If you have any difficulties at all, please give us a call. Thank you and enjoy your MetalCloak Products!

IMPORTANT NOTE: We use Stainless Steel Hardware where possible. Therefore, a tube of Silver Anti-seize is provided and should be used on all bolts—only a small amount is needed.

WARRANTY INFORMATION: This article is sold without warranty expressed or implied. No warranty or representation is made as to this products ability to protect the user from injury or death. The user assumes that risk. The effectiveness, warranty and longevity of this equipment are directly related to the manner in which it is INSTALLED, USED and/or MAINTAINED. THE USER ASSUMES ALL RISK. By purchasing this product and opening the packaging, purchasers expressly acknowledge, understand and agree that they take, select and purchase these MetalCloak products from Armored Works, LLC, its affiliates and distributors and agents as is and with all faults. The entire risk as to the quality and performance of these MetalCloak products is with the purchaser. Working on your vehicle can be a dangerous activity. If you are unsure of what you are doing, please leave mechanical or safety critical work to a skilled mechanic. We take no responsibility for the incorrect use and/or installation of MetalCloak products.

Section 1: Tools & Notes on Installation

Tools Required: This list is the recommended tools for ease of installation. Other versions of the same tool can be used. For example, Allen Wrenches instead of Allen Drive Sockets.



Socket & Ratchet Wrench

14mm Socket 17mm Socket
18mm Socket 19mm Socket
7/16" Socket



3/8" Drill Bit
(3/8" Step Bit Recommended)

14mm Wrench
19mm Wrench



Drill
(Angle Drill Recommended)

3/16" Allen Socket



HOW TO USE THIS GUIDE: The installation guide contains ALL steps for installation. Please read and follow the instructions in order of each page top to bottom, and left to right.

Jeep Model: Instructions may apply to multiple Jeep models, but are labeled separately where appropriate (i.e. TJ vs. LJ).

Options: Because of the number of component options we offer, these instructions may contain steps that will not match your particular configuration. You can skip these steps.

Images: Pictures are provided and parts are labeled throughout the instructions. Each text box contains guidance based on the pictures next to it. The text will refer to alphabetical labels (A, B, etc) found in the images.

Installation Notes: Terms may be used in the body of the instructions that you may not be familiar with, if you have any questions feel free to contact us at the number below, or email techhelp@metalcloak.com

QUESTIONS: Any questions or comments about the instructions? Call us at 916-631-8071 M-F 7:00 AM – 5:00 PM PST.

Section 2: Product Components

DC-0001 REV A

SHEET 1 OF 1

ITEM	PART NUMBER/DESCRIPTION	QTY.
1	7680 STEERING STABILIZER-AXLE MOUNT, JL	1
2	SS-1223 ROCKSPORT STEERING STABILIZER, TJ-JK	1

OPTION 1

STEEL - 7686 STEERING STABILIZER 1.63IN TIE ROD MOUNT
 ALUMINUM - 7687 STEERING STABILIZER 1.63IN BILLET MOUNT

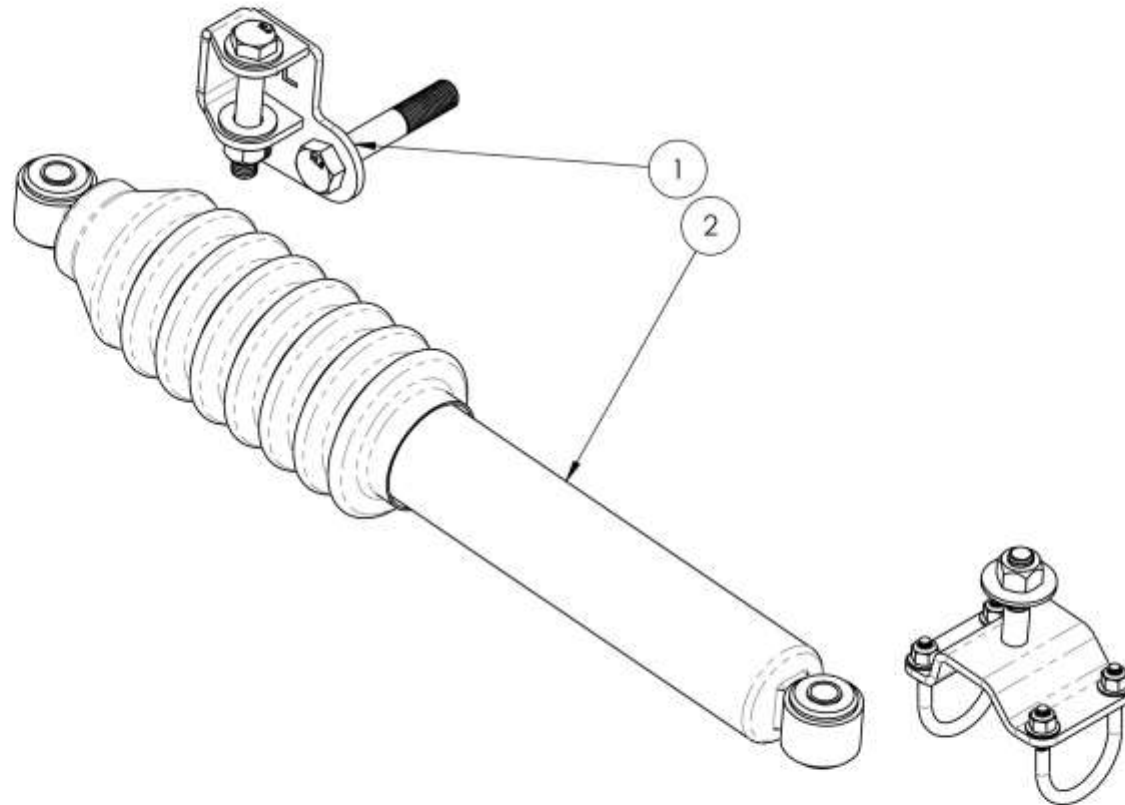

THE INFORMATION CONTAINED ON THIS DRAWING IS
 THE EXCLUSIVE PROPERTY OF ARMORED WORKS, LLC.
 UNAUTHORIZED REPRODUCTION IS PROHIBITED.

DO NOT SCALE DRAWING

PART NUMBER/DESCRIPTION

7681 STEERING STABILIZER KIT, ROCKSPORT, JL

**Metal
Cloak**
 A DIVISION OF ARMORED WORKS, LLC

Section 3: Installation Instructions

Step 1: Steering Stabilizer Axle Mount Installation

- A. Using a 18mm socket remove the stock steering stabilizer
- B. Using a 19mm wrench and socket remove the track bar bolt at the axle. **SAVE HARDWARE.**
- C. Install the steering stabilizer axle mount hand tight using the provided 22mm bolt.
- D. Center punch the second hole and drill with a 3/8" drill bit.
- E. Using a 14mm socket and wrench install the provided bolt.
- F. Fully tighten all hardware.

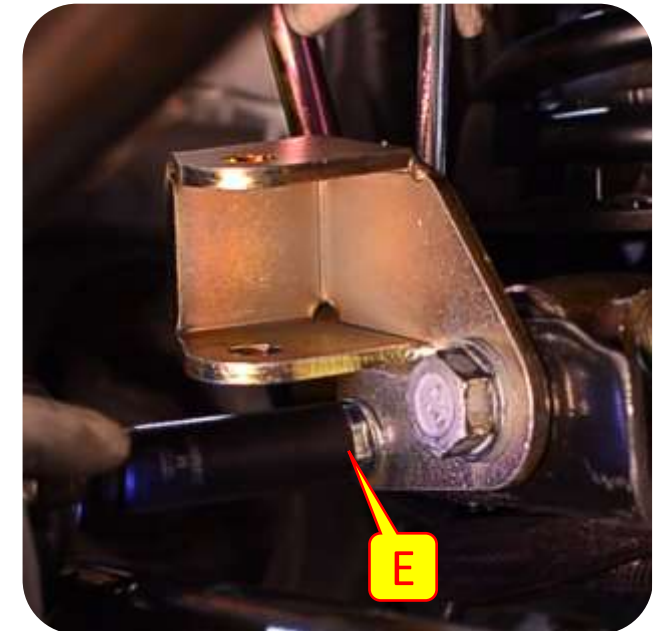
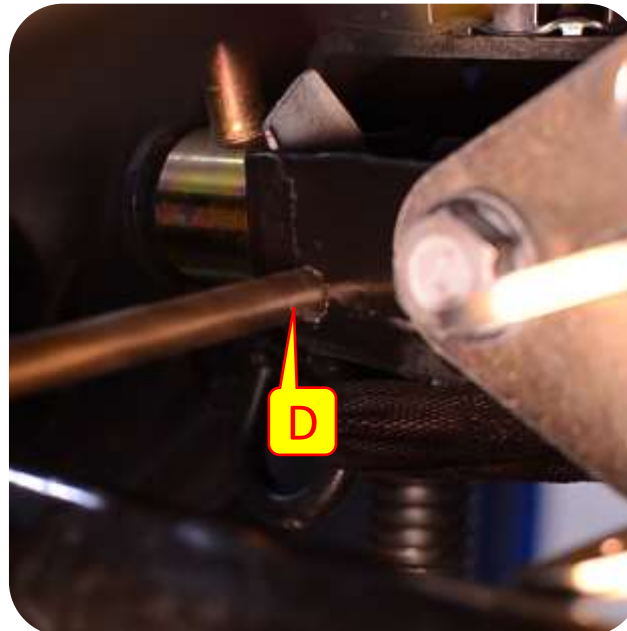
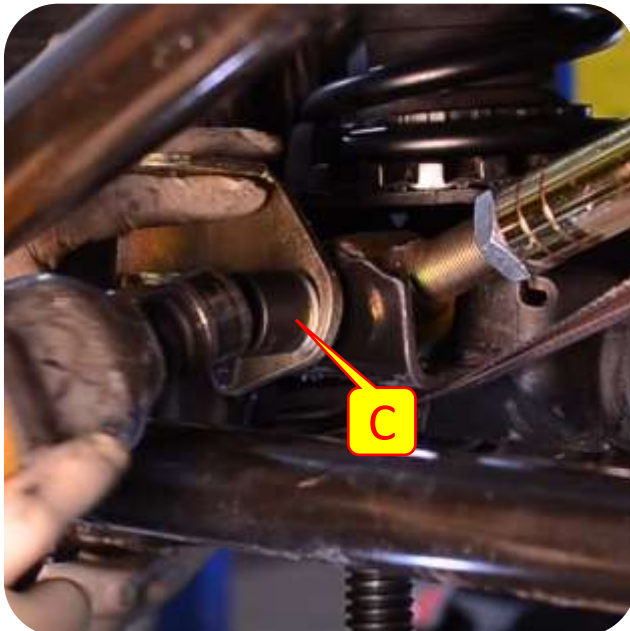
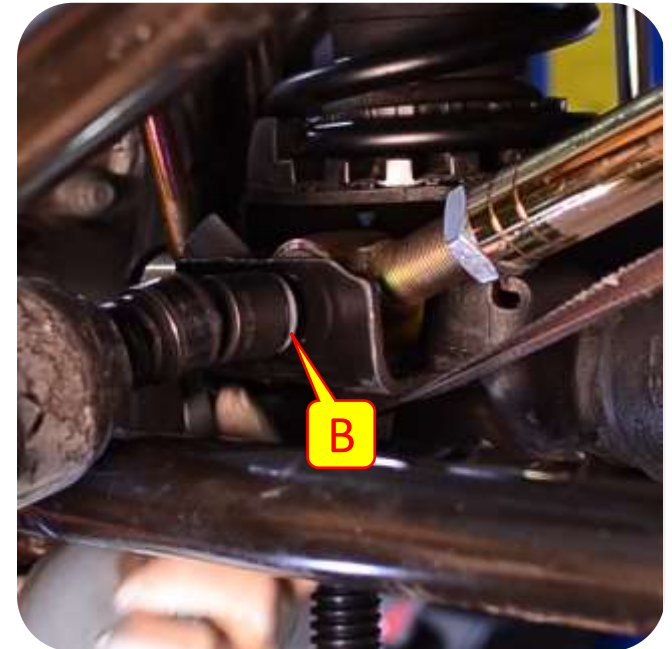

Section 3: Installation Instructions

Step 2: Install RockSport Steering Stabilizer

- G. Using the provided hardware install the steering stabilizer into the Steering Stabilizer Axle Mount.
- H. Place the new bracket on top of the tie rod as shown in the picture. Add the U-bolts, nylock nuts, and washers to hold the plate in place.
- I. Attach steering stabilizer to the 1/2" bolt and use the nut supplied to secure the steering stabilizer to the bracket.
- J. Tighten the Tie Rod mount nylock nuts with a 7/16" socket.
- K. Tighten all the stabilizer hardware using a 19mm socket.
- L. **Make Sure ALL hardware is fully tightened.**

Note: Once fully installed make sure your steering can turn lock to lock.

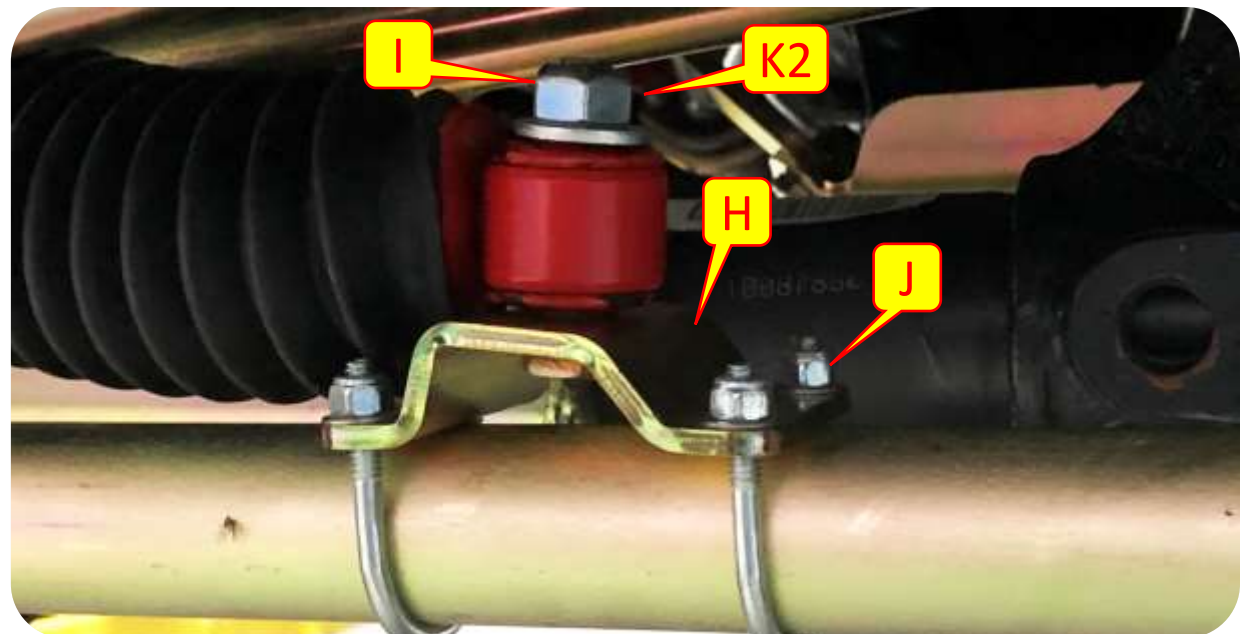
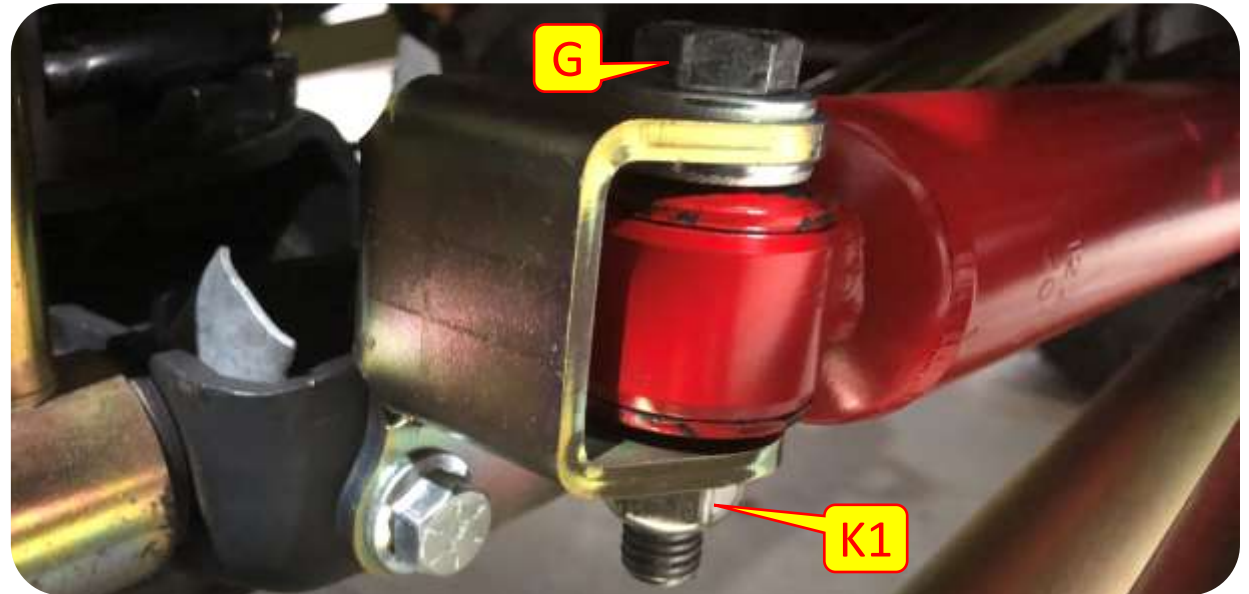

Section 3: Installation Instructions

Step 3: Billet Mount Option

Important Note: MetalCloak highly recommends using anti-seize on all bolts.

- A. Using the provided allen head bolts loosely mount the billet bracket to the tie rod.
- B. Turn the steering wheel all the way driver and fully extend the steering stabilizer.
- C. Move the billet mount to the new location and install the stabilizer hand tight using the provided washer and bolt.
- D. Using a 3/16" allen socket tighten the bolts of billet mount to the tie rod. Make sure the bolts are tightened evenly.
- E. Using a 17mm socket tighten the stabilizer bolt.

