



PRODUCT: **JK True Dual Rate Lift Kit, Fox Edition**

REV: G | 04-02-2024 | II-A1125/A1135

READ INSTRUCTIONS IN FULL BEFORE INSTALLATION.
QUESTIONS? CALL 916-631-8071 M-F 7:00 AM – 5:00 PM PST

The MetalCloak experience includes the ease of installation of our products. We design for most contingencies, but installation may be different based on different Jeep condition, configuration and/or year.

We are continually trying to improve our products and instructions – please help us by providing feedback and pictures if you find any part of the instructions that do not match your particular Jeep or are not easily understandable.

If you have any difficulties at all, please give us a call. Thank you and enjoy your MetalCloak Products!

IMPORTANT NOTE: We use Stainless Steel Hardware where possible. Therefore, a tube of Silver Anti-seize is provided and should be used on all bolts—only a small amount is needed.

SUSPENSION WARRANTY INFORMATION: MetalCloak products are warranted to be free of defects in material and workmanship for one year from the original purchase date. All products produced by MetalCloak are designed exclusively for off road applications and therefore do not have any warranty or guarantee of performance. No warranty or representation is made as to this products ability to protect the user from injury or death. The user assumes that risk. Because of the wide variety of applications of our products, the effectiveness, warranty and longevity of this equipment are directly related to the manner in which it is installed, used and/or maintained. The entire risk as to the quality and performance of these MetalCloak products is with the purchaser. Working on your vehicle can be a dangerous activity. If you are unsure of what you are doing, please leave mechanical or safety critical work to a skilled mechanic. We take no responsibility for how MetalCloak products are installed.

Section 1: Tools & Notes on Installation



Tools Required: This list is the recommended tools for ease of installation. Other versions of the same tool can be used. For example, Allen Wrenches instead of Allen Drive Sockets. Be sure to use metric on metric and SAE on SAE.



Socket & Ratchet Wrench

Metal Head Hammer



10" Socket Extension

Electric Drill



Center Punch

Philips Screwdriver

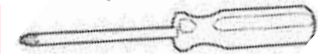

Retaining Ring Pliers

5/16" Allen Drive Socket



Cut-Off Disc and Grinder
(Optional)

12mm Brake line Wrench
17mm Brake line Wrench



10mm Socket	12mm Socket
14mm Socket	15mm Socket
16mm Socket	18mm Socket
1/2" Socket	5/8" Socket
3/4" Socket	13/16" Socket
7/8" Socket	21mm Socket

12mm Wrench	14mm Wrench
17mm Wrench	18mm Wrench
19mm Wrench	1-1/2" Wrench
1-7/8" Wrench	3/4" Wrench
9/16" Wrench	3/8" Wrench
5/8" Wrench	9/32" Wrench
1/2" Wrench	



3/8" Drill Bit	L Drill Bit
1/4" Drill Bit	1/2" Drill Bit
7/16" Drill Bit	9/16 Drill Bit

Section 1: Tools & Notes on Installation



HOW TO USE THIS GUIDE: The installation guide contains ALL steps for installation. Please read and follow the instructions in order of each page top to bottom, and left to right.

Jeep Model: Instructions may apply to multiple Jeep models, but are labeled separately where appropriate (i.e. TJ vs. LJ).

Options: Because of the number of component options we offer, these instructions may contain steps that will not match your particular configuration. You can skip these steps.

Images: Pictures are provided and parts are labeled throughout the instructions. Each text box contains guidance based on the pictures next to it. The text will refer to alphabetical labels (A, B, etc) found in the images.

Installation Notes: Terms may be used in the body of the instructions that you may not be familiar with, if you have any questions feel free to contact us at the number below, or email techhelp@metalcloak.com

QUESTIONS: Any questions or comments about the instructions? Call us at 916-631-8071 M-F 7:00 AM – 5:00 PM PST.

Section 3: Installation Instructions



Important Note: *If using stock wheels with factory backspacing the #7104 outboard shock mount is not recommended as it will interfere with the wheel.*



Important Note: *MetalCloak provides "rear specific" end-links that have shorter bolt lengths that will keep for optimal fitment.*

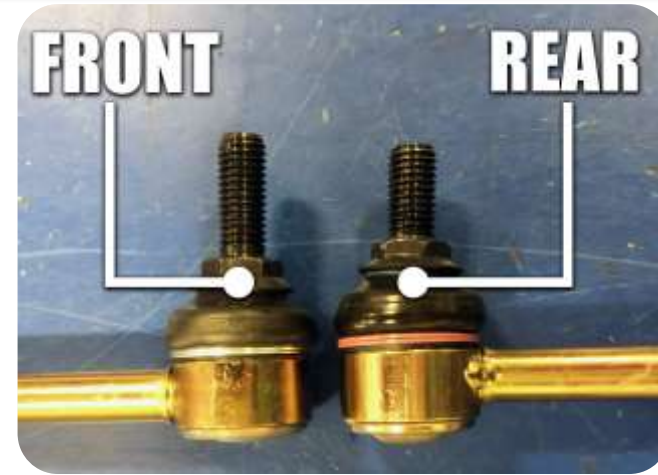

Important Note: *MetalCloak does not recommend powder coating your True Dual Rate Coils. The baking process in powder coating can, in some cases, cause the metallurgical properties of the coils to be changed, resulting in the loss of the lift properties of the coils. As such, the process of powder coating the coils will void any warranty stated or implied in relation to the coils.*

Important Note: *To install lift components, you will need to fully 'droop' your suspension in the front and rear (though not at the same time). we strongly recommend that the vehicle be placed on an automotive lift and that all appropriate safety precautions be taken to secure the vehicle while it is off the ground. always use the necessary axle stands (or equivalent) to support the axle when the suspension components are disconnected for safety, and to ensure the integrity of your suspension system during the installation process.*

Important Note: *To prevent tires from rubbing the shocks at full turn and flex, a clearance of 11-3/4" between inner wall of the tire and the outside of the frame rail is recommended. Wheel backspacing, wheel spacers, axle width and tire width can effect this value. We recommend a wheel backspacing of less than or equal to 4.0" for most common vehicle builds.*

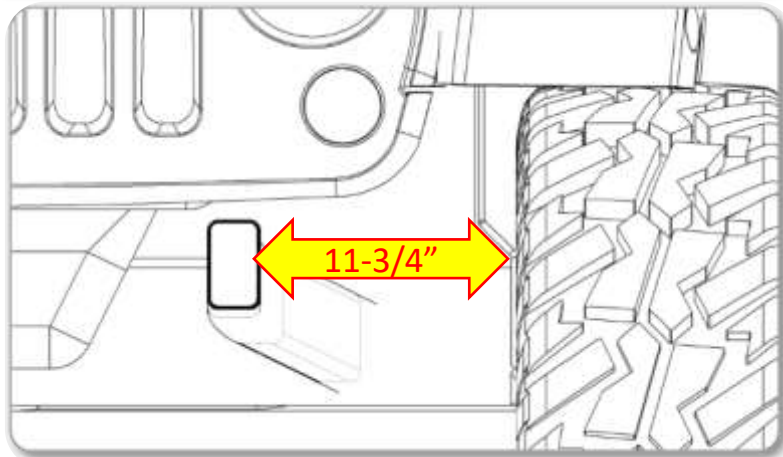

Section 3: Installation Instructions

Step 1: Remove Stock Components

- A. Disconnect front sway bar links.
- B. Watch the brake lines as the axle drops! Unbolt the bracket from the frame in case the lines are stretched while working.
- C. Remove the front track bar.
- D. Remove stock springs, and any spacers that have been used if vehicle has been previously lifted.
- E. Use a 16MM (5/8") Socket and Wrench to remove the stock nut on top of the upper shock mount tower.
- F. Use a 19MM (3/4") Socket and Wrench to remove the stock nut and bolt from the lower shock mount bracket located on the axle.
- G. Remove stock front shocks.

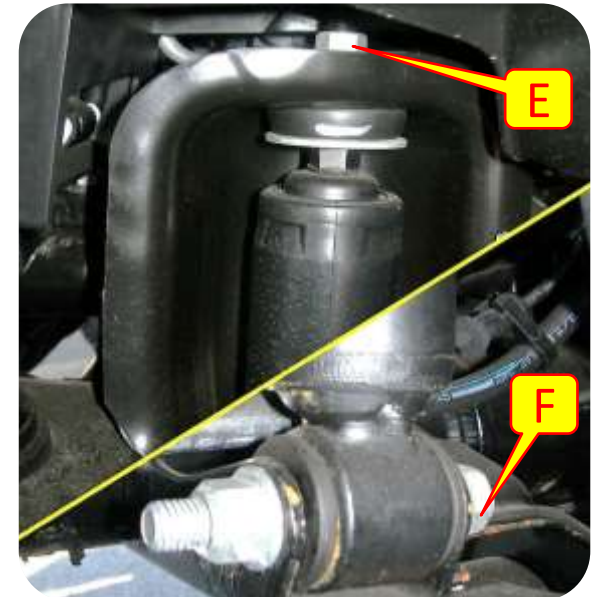
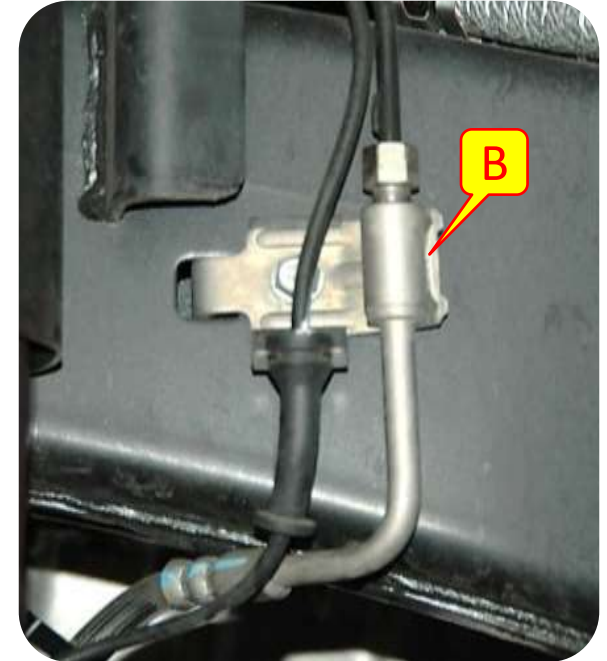

Section 3: Installation Instructions

Step 2: Install Front Brake Line

- H. Use a 15mm Socket to remove the 'banjo' bolt from the brake calipers. You will want an oil drain pan to catch the brake fluid.
- I. Unclip the ABS line from the brake line (all the way down) and use a 10mm Socket to remove the bolt holding the stock bracket. Remove the frame clip and discard.
- J. Use a 12mm Wrench to unscrew the stock brake line from the frame bracket.

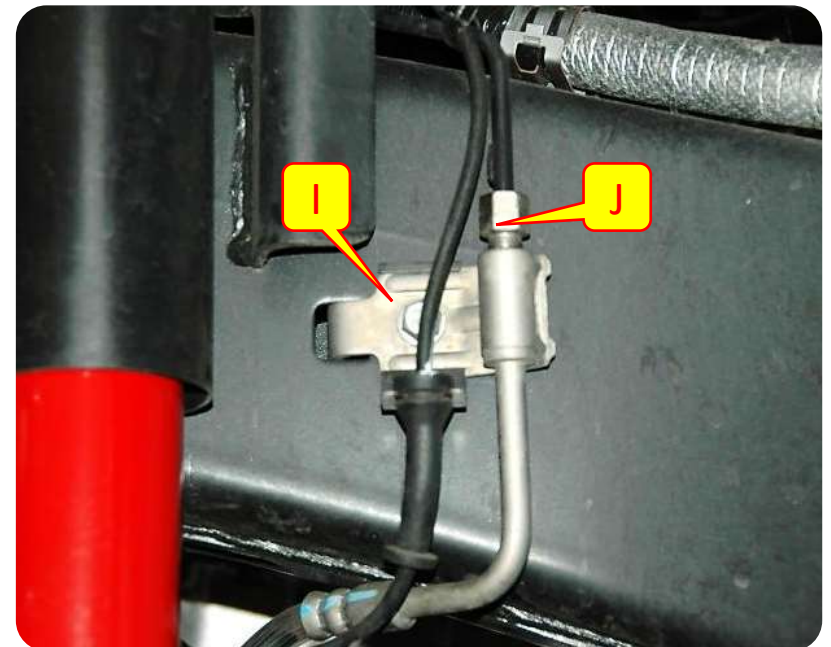
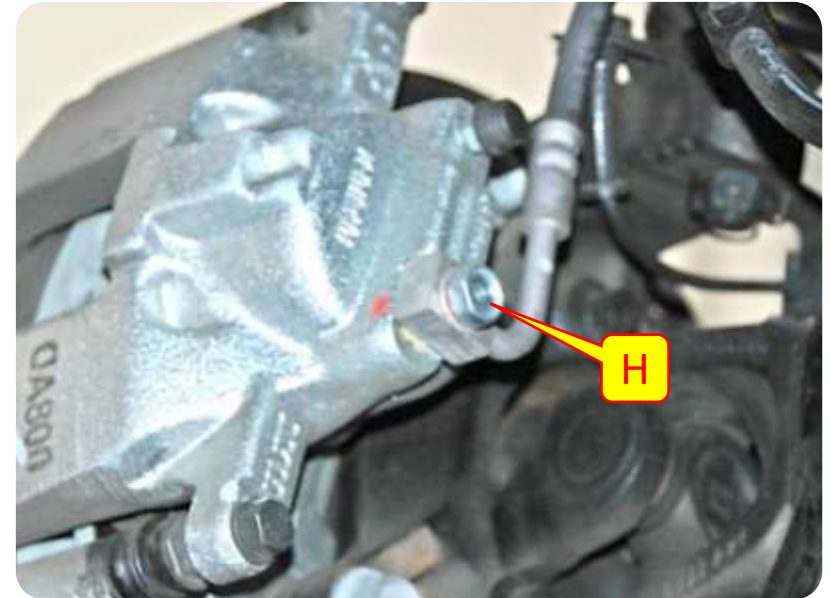

Section 3: Installation Instructions

Step 2: Install Front Brake Line

- D. Space the provided L-Bracket 1" rearward from the frame opening, and center-punch or mark the hole location.
- E. Drill the hole with an '1' [.272"] Drill.
- F. Use a 1/2" Socket to install the 5/16"-18 Hex Head Self-Tapping Screw. Do not fully tighten.
- G. Install the 24-1/2" Brake Line through the bracket. Screw the stock line into the new Brake Line and tighten using a 12mm and 17mm Wrench.
- H. Install the provided Spring Clip to retain the Brake Line in the Bracket. You may need a hammer to lightly tap this clip into place. Fully tighten the 5/16" Screw.
- I. Feed the banjo screw through the square end of the Brake Line. Use the provided Brass Washers on both sides of the Brake Line as shown.
- J. Re-install the banjo screw into the brake caliper.
- K. Zip-tie the ABS line to the new Brake Line.

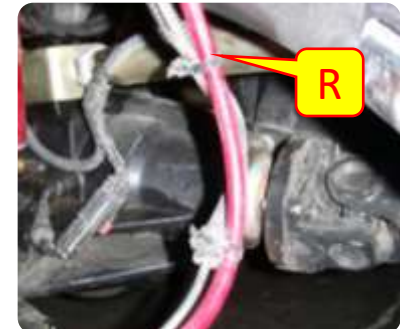
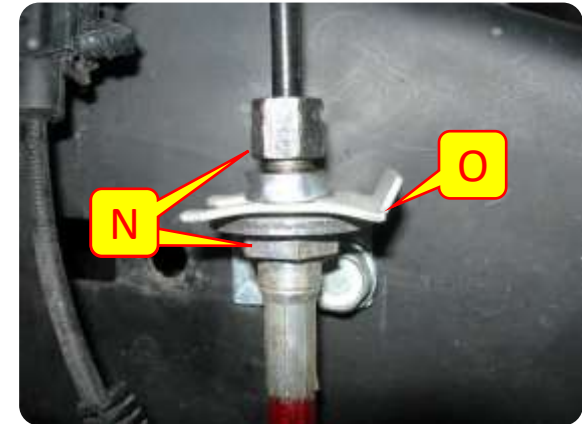
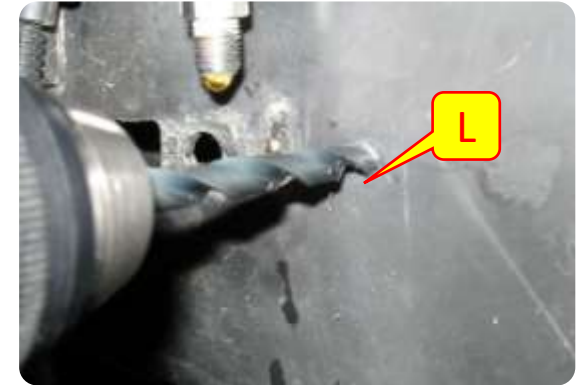
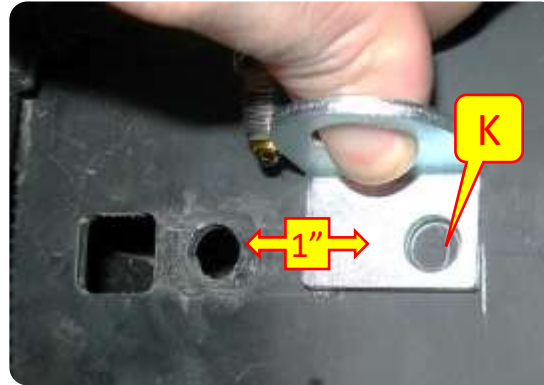

Section 3: Installation Instructions

Step 3: Swap Control Arms (Front Uppers)

- L. Use an 18mm Socket & Wrench to remove the stock bolts. You will need a socket extension to access the head of the upper bolt inside the frame [L1].
- M. The exhaust on the passenger side of some models interferes with removal of the upper bolt. Cut the stock bolt and replace it with the ½-13 x 3 ¼" Flange Hex Head Bolt and ½"-20 Hex Flange Nut provided, install bolt from the outside of frame and the nut inside the frame.

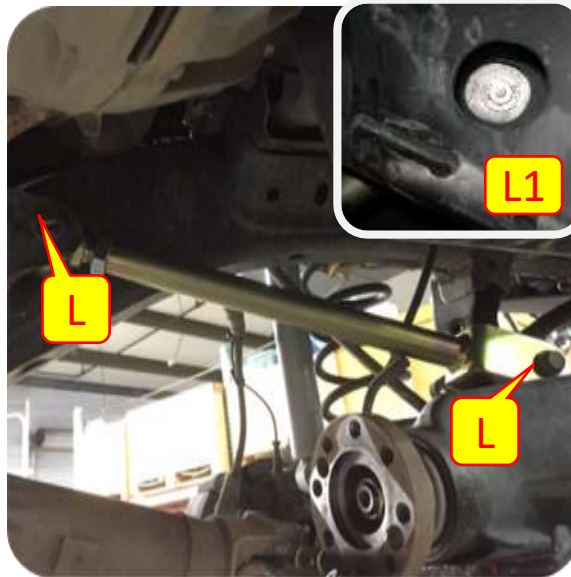

Use the chart below to identify and pre-set the length of your control arms. Hand tighten the lock nuts, for now.



		FRONT CONTROL ARMS		REAR CONTROL ARMS	
CASTOR ANGLE		UPPER	LOWER	UPPER	LOWER
FACTORY CONTROL ARMS	STOCK	22 5/8"	18 3/4"	19 3/4"	17 7/16"
METALCLOAK 2.5"/3.5" LIFT	5 DEGREES	23 1/16"	18 3/4"	20 7/16"	18 7/16"

Section 3: Installation Instructions



Step 4: Coil Isolator Information Guide

Important Note: MetalCloak's suspension systems include a unique coil design that utilizes upper isolators to position the coil. The following table will help you identify where to install the isolators included with your kit. You must remove the stock isolators before installing the provided coil isolators. If you have any questions give us a call at 916-631-8071.

Coil Isolator Jeep Locations		
Tall Isolator	Jeep Model	Installation Locations
	JL Wrangler 3.6L Non-E Torque	Upper Front Passenger
	JL Wrangler 2.0T E-Torque	Upper Front Driver & Passenger
	JL Wrangler 4xE	Upper Front Driver & Passenger
	JL Wrangler Diesel	Upper Front Driver & Passenger
	JT Gladiator Diesel	Upper Front Driver & Passenger
Short Isolator	JK Wrangler (All Models)	Upper Front Driver & Passenger
	JL Wrangler 3.6L Non-E Torque	Upper Front Driver
	JL Wrangler 3.6L E-Torque	Upper Front Driver & Passenger
	JL Wrangler Turbo	Upper Front Driver & Passenger
	JL Gladiator 3.6L Motor	Upper Front Driver & Passenger
	Rear Isolator	JL Wrangler 3.6L Non-E Torque
	JL Wrangler 4xE	Upper Front Driver & Passenger

Section 3: Installation Instructions

Step 5: Install Front Bump Stops & Coils

- N. Center a Bump Stop Disk on the top of the spring perch and mark the center of the hole.
- O. Drill a hole at the marked location. You can use any drill size from size 1/2" to size 9/16".



Section 3: Installation Instructions

Step 5: Install Front Bump Stops & Coils

- P. Select the appropriate Screw length so that the threads stick out of the bottom Disks approximately $3/4"$. Assemble your bump stops by feeding the $1/2"$ Countersunk Screw through the Cover Plate, and then threading through the Bump Stop Disks. The center hole in the Disk is intentionally small to create the most rigid assembly possible after installation.
- Q. **IMPORTANT!** Place the assembled Bump Stop inside the spring before re-installing. Re-install the spring and place the end of the $1/2"$ Screw in the drilled hole.
- R. The $1/2"$ Screw is backed by a $1/2"$ Flanged Nylon Lock Nut. Install the nut and tighten the hardware using a $5/16"$ Hex Key Socket or Allen Wrench and a $3/4"$ Wrench. Tighten until everything is tight; the hardware will not bottom out, but instead will begin to compress the Disks.
- S. Repeat all steps for other side.

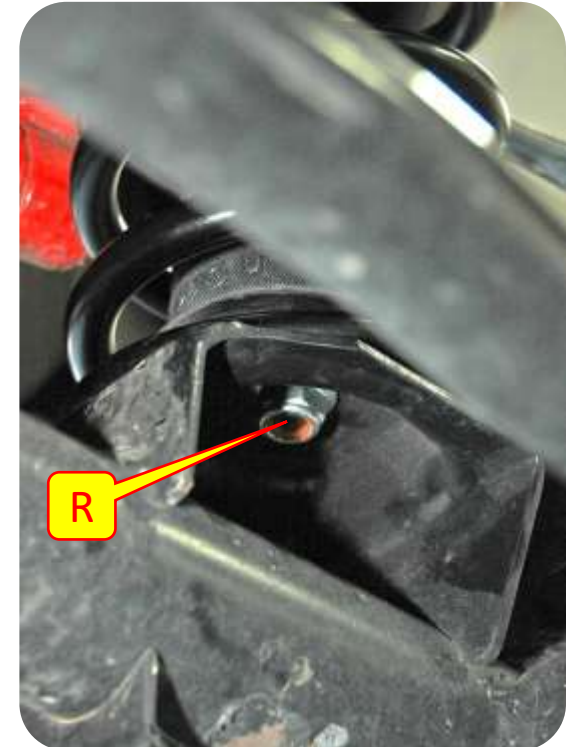

Section 3: Installation Instructions

Step 5: Install Front Bump Stops & Coils

- T. If the axle does not “droop” enough to allow the coil to be put in place a coil compressor can be used to compress the coil to allow fitment.
- U. Install Front Dual Rate Coils with the tightly wound coils oriented upward.
- V. Slip the bottom of the coil onto the coil base on the axle.



Section 3: Installation Instructions

Step 6: Install Front Shocks

Important Note: *If using stock wheels with factory backspacing the outboard shock mount is not recommended as it will interfere with the wheel.*

- W. Slide the stock shock bracket into the outboard shock spacer making sure the holes align.
- X. Mark the hole located on the bottom of the shock mount.
- Y. Drill out all three holes using a 3/8" drill bit.

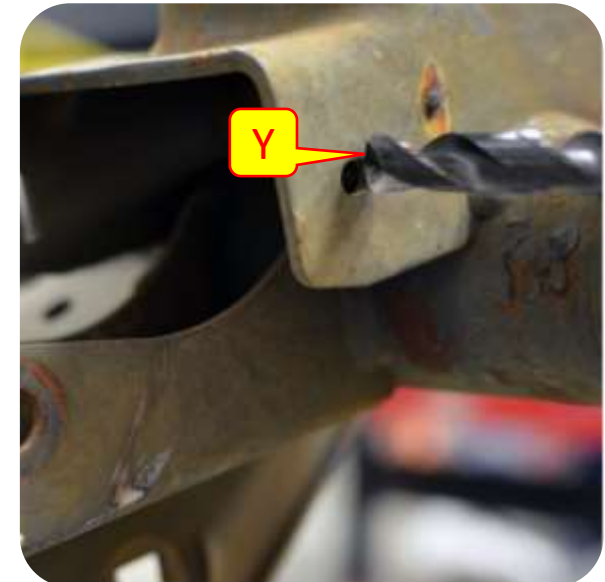
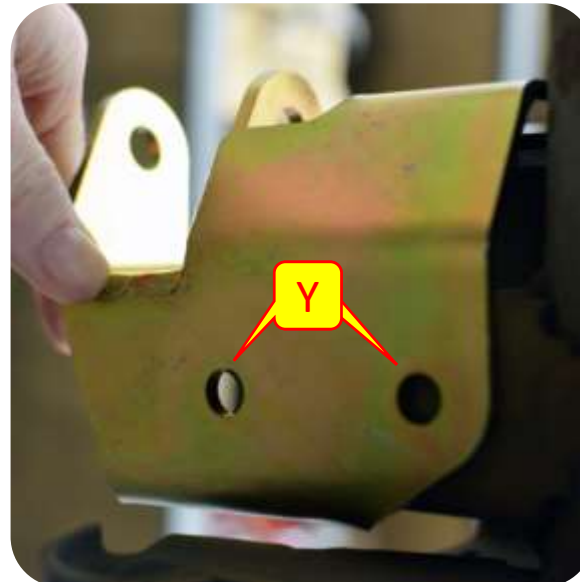
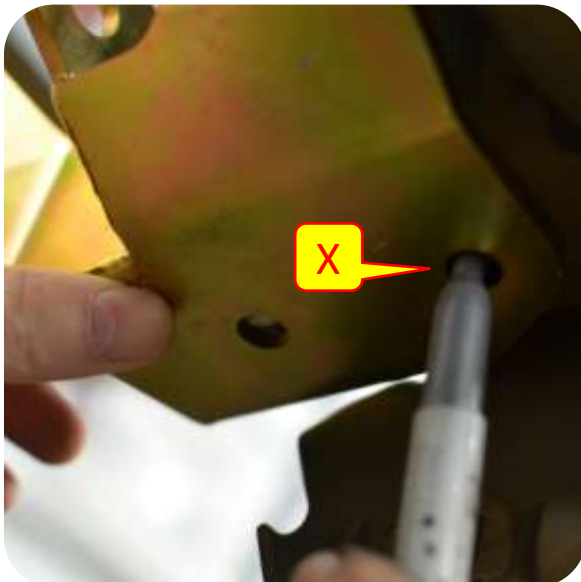
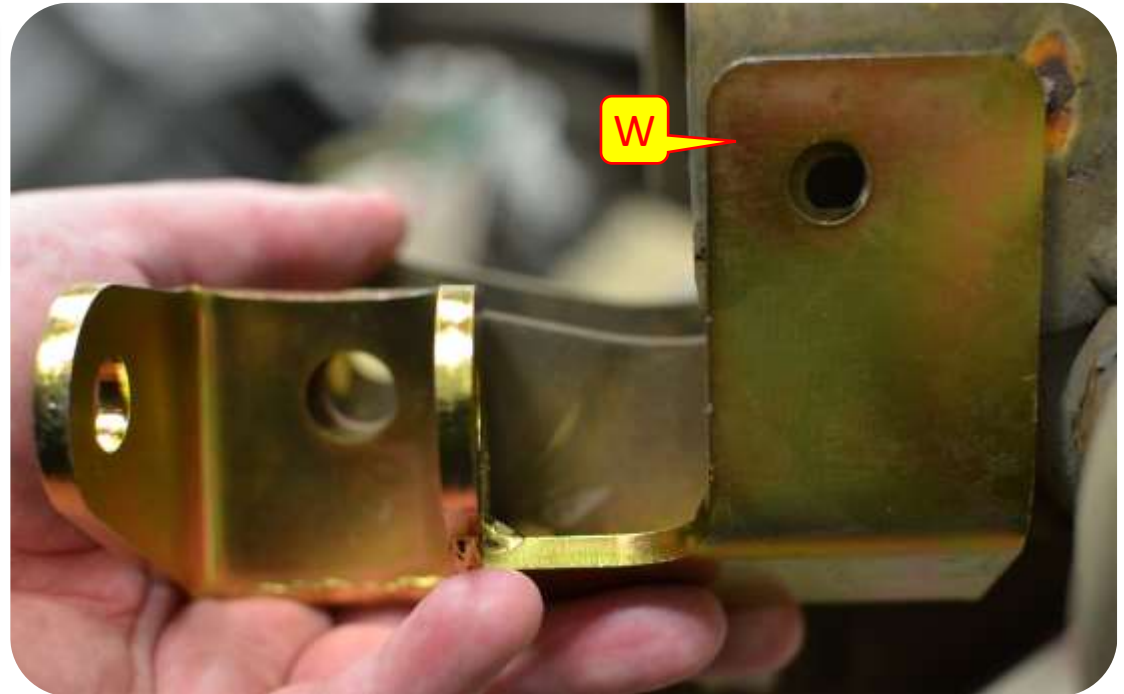

Section 3: Installation Instructions

Step 6: Install Front Shocks

Z. Install 2 bottom bolts hand tight.

AA. Install the side bolt hand tight

BB. Insert the spacer in the space between the stock shock mount.

CC. Install spacer bolt and washers.

DD. Tighten all hardware.

Flange Bolts – 14MM Socket & Wrench

Hex Bolts – 19MM Socket & Wrench

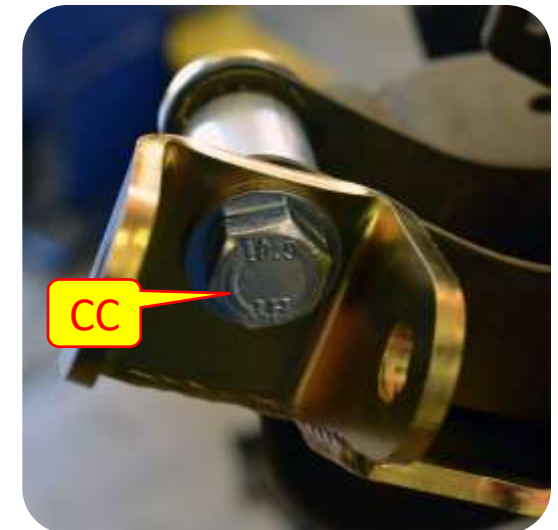
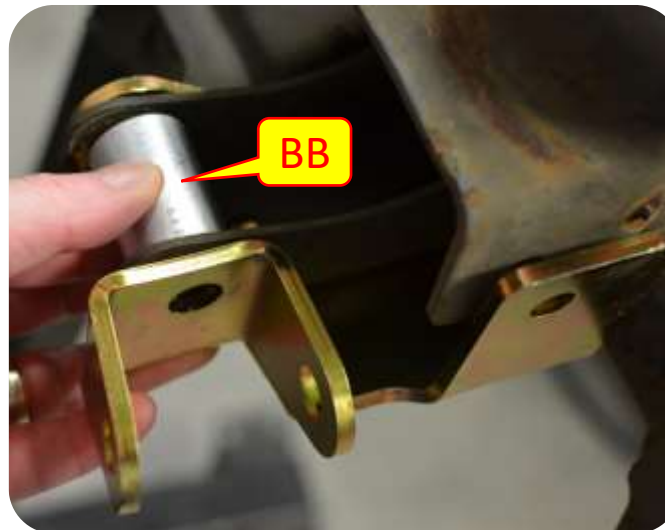
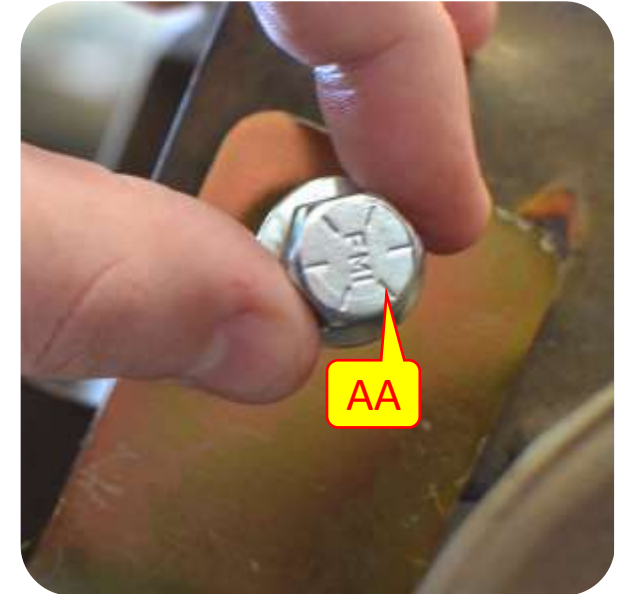
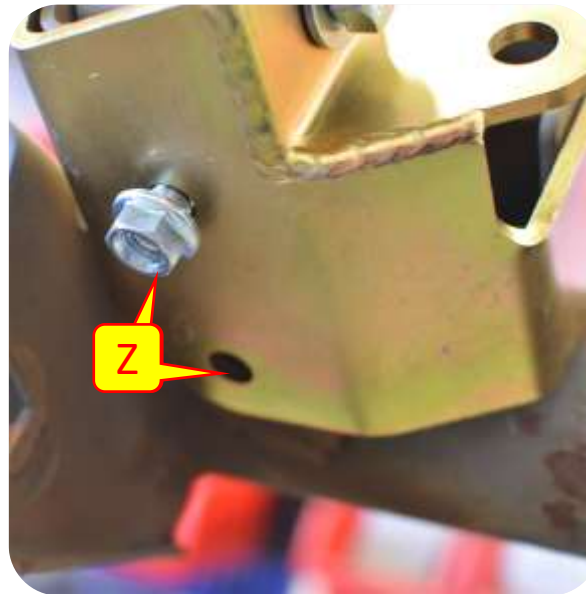

Section 3: Installation Instructions

Step 6: Install Front Shocks

- EE. Install the Fox front shocks (Part # 98224922). Put the upper shock pin through the upper tower first and bolt into place (do not tighten). It may be necessary to grind some of the plastic engine guard components above the shock tower.
- FF. Align the shock with the outboard shock spacer.
- GG. Install stock hardware.
- HH. Using a 18mm wrench and socket tighten stock hardware.
- II. Torque all bolts to 35 ft/lbs.

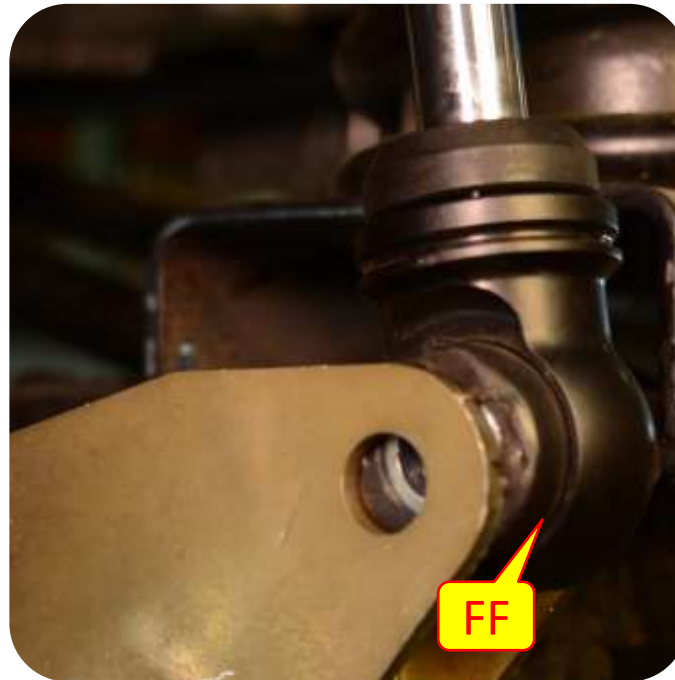

Section 3: Installation Instructions

Step 7: Install JK Front Track Bar

- JJ. The fixed end of the MetalCloak JK Front Track Bar goes in the stock frame bracket. The clearance bends should point toward the front bumper, up and away from the differential cover. Re-use the stock hardware, and only hand tighten the hardware for now (you will fully tighten everything at the end).
- KK. The adjustable end of the Track Bar goes into the stock bracket on the axle, again re-using the stock hardware. With the full weight of the vehicle on the springs, push the bolt through the bracket and the Track Bar joint.
- LL. Fully tighten the stock hardware on both ends of the Track Bar, and then tighten the Jam Nut on the Track Bar.

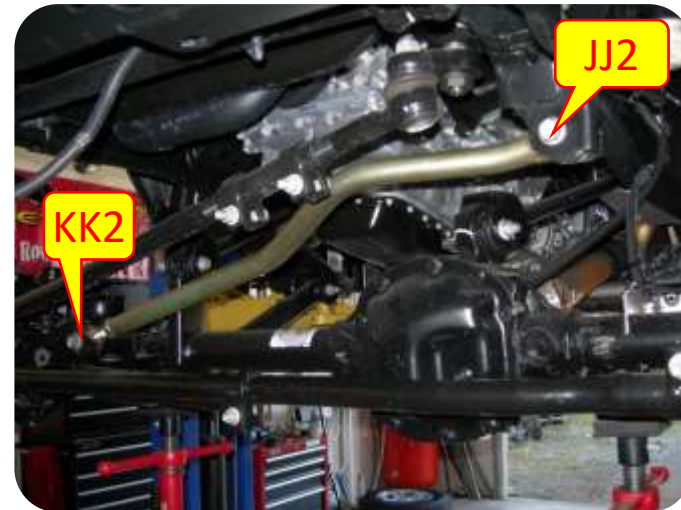

Note: It is helpful to have someone push the vehicle to the driver or passenger side to help align the hole; if you don't have an extra pair of hands, you can use a ratchet strap on the frame/axle to pull the frame in the desired direction. Check to ensure the axle is centered once the bolt is in place. If not then remove the bolt, adjust the Track Bar length, replace the bolt, and re-check axle centeredness. Repeat until the axle is as close to center.

Section 3: Installation Instructions

Step 8: Install Sway Bar Links

Note: *These sway bar link instructions are for the non-rubicon sway bar disconnect links. If you have the Rubicon sway bar link kit continue to step 9.*

Important Note:
MetalCloak recommends using red Loctite on each of the upper spindles of the sway bar end links.

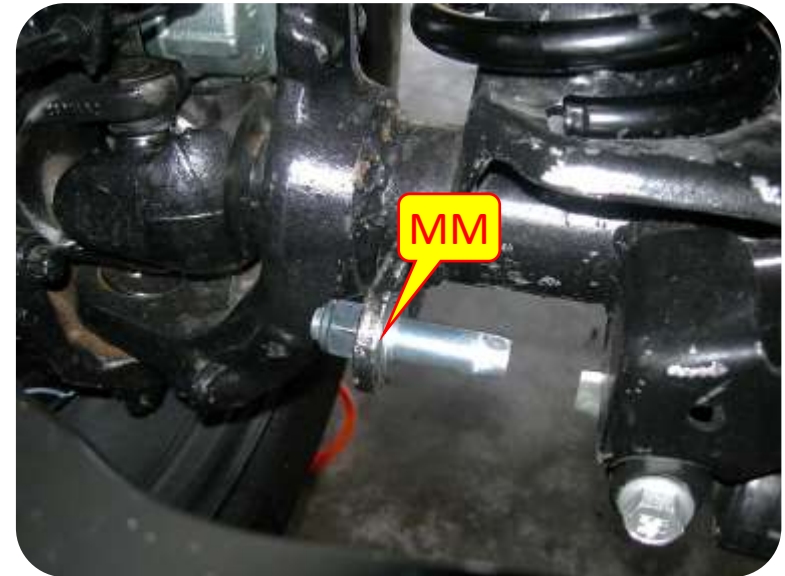

MM. Install the lower quick disconnect pin in the stock location. Point the pin toward the center of the vehicle, backed by the provided ½"-13 hardware. A screwdriver through the hole on the end of the pin is helpful while tightening the nut with a ¾" wrench.

NN. Assemble the sway bar link by threading a jam nut onto the lower link.

OO. Now thread the link into the ball joint. Set the length to 12.25". Do not tighten Jam nut yet.

PP. Install the ball joint on the outside of the sway bar end. You will need a thin 9/16" box end wrench to keep the ball joint from turning while you tighten the nut with a 5/8" wrench.

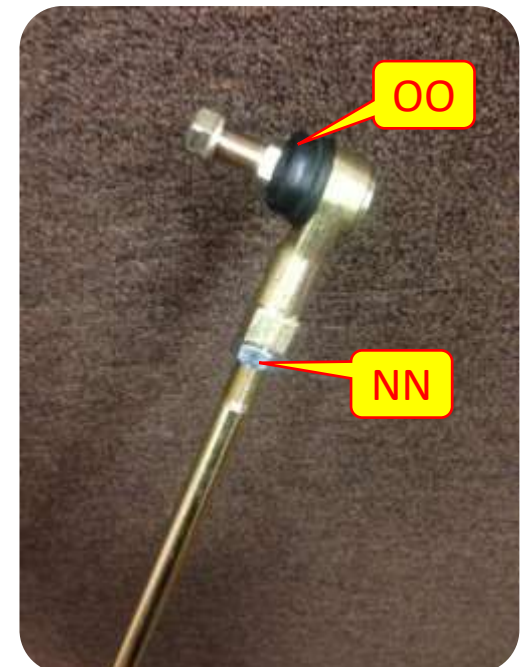
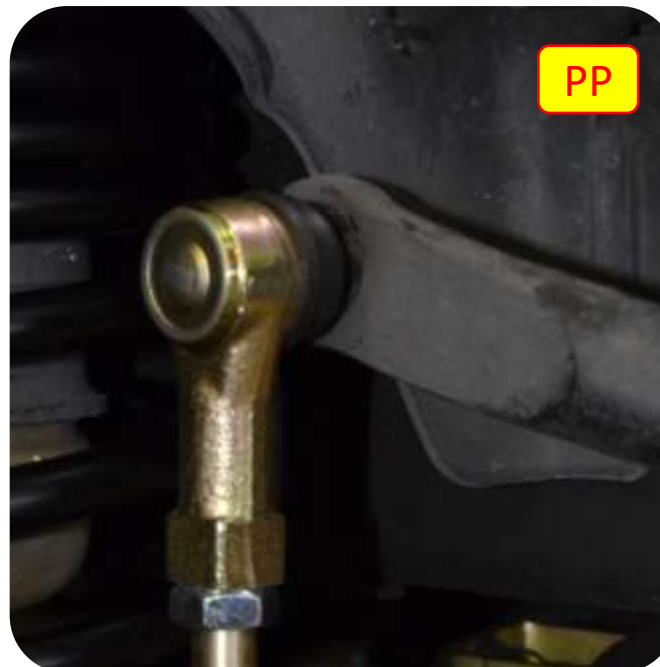

Section 3: Installation Instructions

Step 8: Install Sway Bar Links

QQ. Installed lower rubber bushing on the quick disconnect pin.

RR. Tighten the jam nut.

SS. Disconnect the links and align the provided brackets in the desired location. There is no exact location; the goal is simply to keep the sway bar clear of the tires when stowed. Mark the locations and drill with a 9/32" drill bit. Install the self-tapping screws through the bracket using a 1/2" wrench.

TT. Re-attach the links to the lower pins and install the 1/4" Locking Pins. These may be snug against the rubber bushing, so don't be surprised if you need to use a little muscle to push them through.

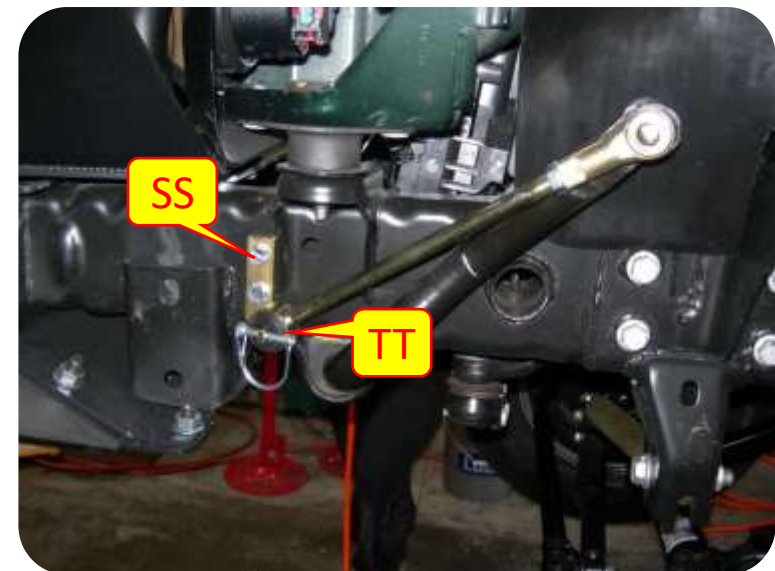

Section 3: Installation Instructions

Step 9: Install Sway Bar Links (Option 2)

UU. Use the two 18mm wrenches or socket to unbolt the lower bolt of the sway bar end link.

VV. Use the 19mm wrench to hold ball socket side on upper attaching point (Inside the rubber cover).

WW. Use the 18mm wrench for the back side of the sway bar to remove the nut.

XX. Remove the factory sway bars.

Note: Keep all factory hardware.

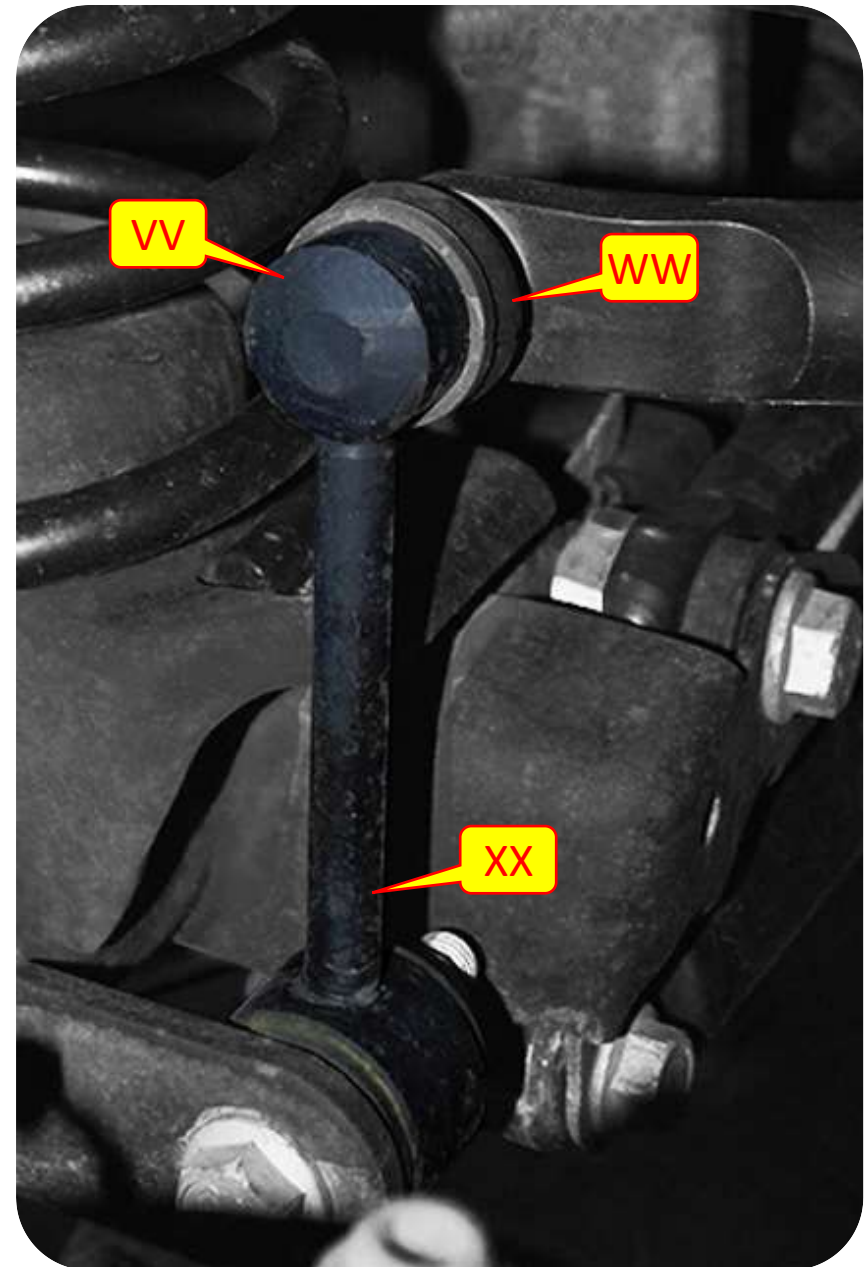

Section 3: Installation Instructions



Step 9: Install Sway Bar Links (Option 2)

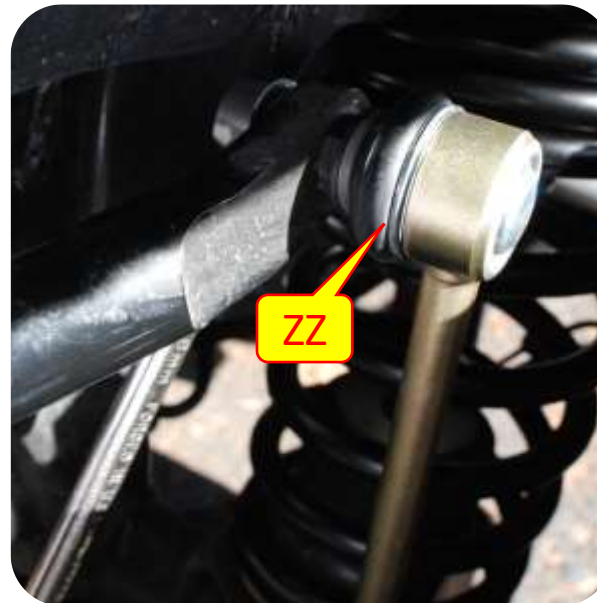
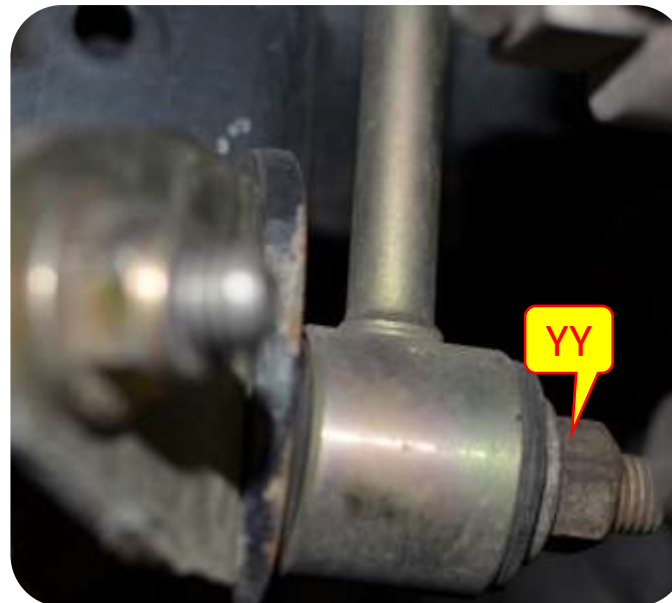

YY. Using the factory hardware install the bottom of the MetalCloak extended sway bar links.

ZZ. Using the factory hardware install the top of the MetalCloak extended sway bar links.

AAA. Torque upper and lower bolts to 75lbs.

Section 3: Installation Instructions



Step 1: Remove Stock Components

Note: When lifting any vehicle, basic dynamics are changed. It is important for you to take your vehicle to a professional for alignment after installation. When doing so, make sure he is setting caster for lifted vehicle (not stock specs).



A. Disconnect rear sway bar links.

B. Disconnect rear brake lines.

Note: The steps to replace the rear brake lines are essentially identical to the front. The only difference is that in the upper rear you will re-use the stock screw and frame clip. Use the M6 screw to install the L-Bracket in the stock location, and then install the Brake Line following the same steps as the front.

C. Remove the shocks.

D. Remove stock springs, and any spacers that have been used if vehicle has been previously lifted

Section 3: Installation Instructions

Step 2: Install Stock Brake Line Relocation Bracket

Note: You do not have to bleed the rear brakes.

- E. Unclip the ABS line from the brake line (all the way down) and use a 10mm Socket to remove the bolt holding the stock bracket (Keep frame clip attached to frame).
- F. Stock Brake Line Relocation Bracket.
- G. Place a provided washer behind Stock Brake line relocation bracket and using original hardware use 10mm socket to install bracket in factory location.
- H. Using hardware provided attach brake line bracket to relocation bracket using a 11mm (7/16") socket and a 5/32" hex drive socket or allen wrench.

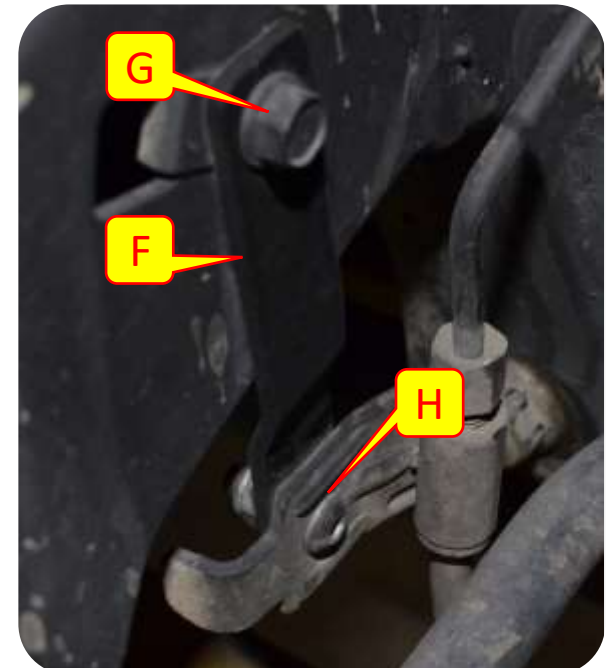

Section 3: Installation Instructions

Step 3: Install Rear Bump Stops

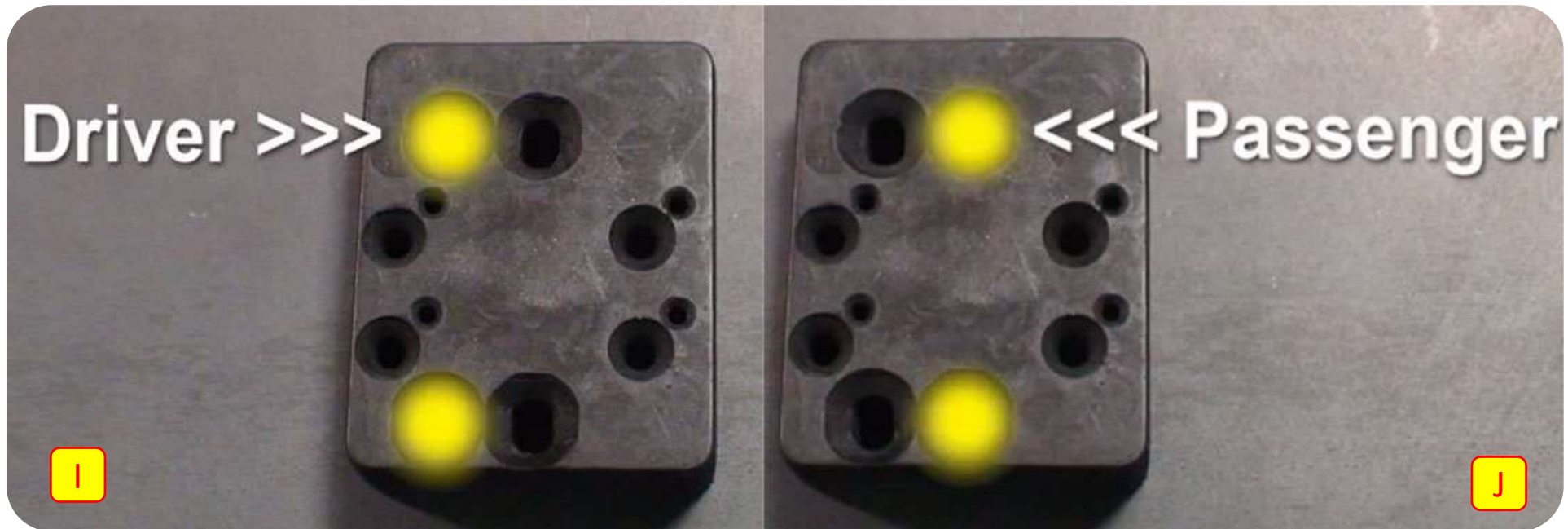

- I. Driver Side Bump Stop Holes.
- J. Passenger Side Bump Stop Holes.
- K. Diagram showing the two sides of the Bump Stops.

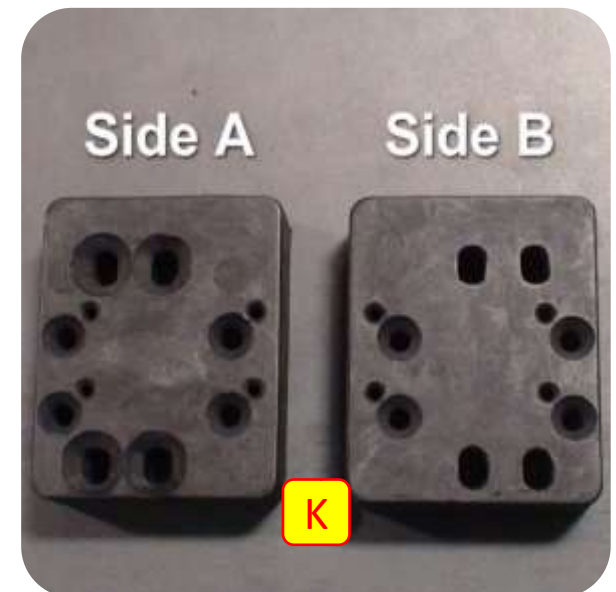

Section 3: Installation Instructions

Step 3: Install Rear Bump Stops

- L. Install first bump stop puck (Side A) using the correct holes (shown in step A and B) using the 5/16 bolt with the matching nut and washer.
- M. Install next puck (Side B) using the 1 3/4" woodscrews.
- N. Continue until desired bump stop height (Side A/Side B/ Side A/Side B).

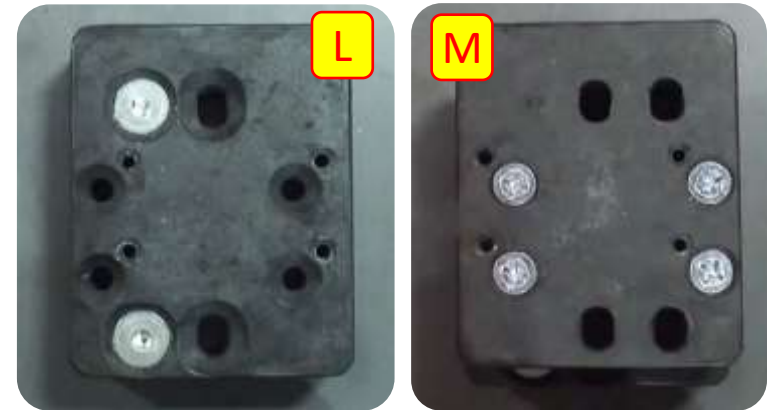

Step 4: Install Sway Bar Links / Drops

Note: Based on the kit you've purchased you will either have the Sway Bar Drop Bracket (7026) or the Sway Bar Links (7015) These instructions are for the Sway Bar Drop Bracket. If you have the Sway bar link kit you will need to unbolt the factory links at the top and bottom and attach extended length 12.5" links.

- O. Rear Sway Bar Drop Bracket
- P. Re-use the stock hardware to screw the drop bracket to the frame in the stock location. The bracket should be roughly vertical.
- Q. Using the provided hardware use a 14mm or 9/16" hex socket or wrench to bolt the sway bar to the bottom of the drop bracket .
- R. Re-attach the sway bar links.

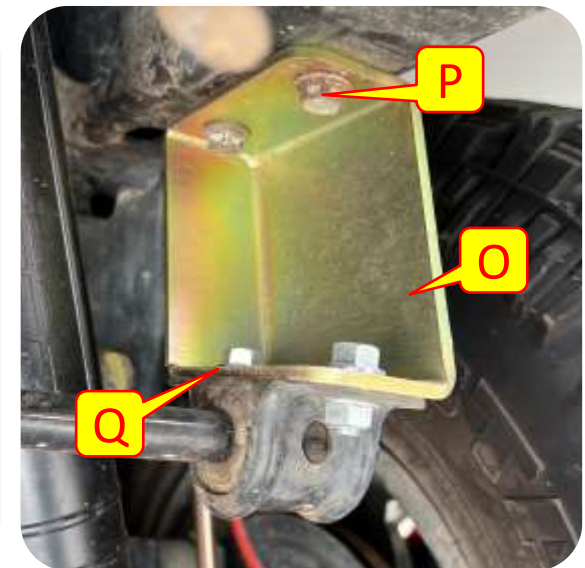

Section 3: Installation Instructions

Step 5: Install Rear Track Bar Bracket

- S. Slide the MetalCloak Track Bar Bracket in place as shown and re-install the stock bolt through the control arm; do not fully tighten any hardware until the Bracket is fully installed.
- T. Insert the provided Spacer in the axle bracket where the stock track bar was mounted.
- U. Install the provided M14-2x100mm Hex Cap Screw through the stock hole with a Washer under the head of the Screw.
- V. The Screw is backed by a M14 Nylon Jam Locknut and Washer; install but do not fully tighten.
- W. Use a 3/4" Socket to install the 1/2"-20 U-bolt with the provided 1/2"-20 Flange Locknuts. You can snug all the Bracket hardware at this time, but do not fully tighten.
- X. Re-install the factory rear track bar.

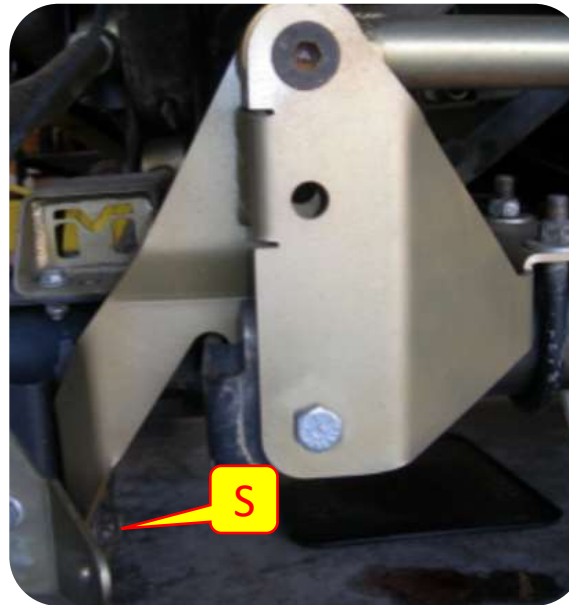

Section 3: Installation Instructions

Step 6: Install Rear Dual Rate Coils

- Y. If the axle does not “droop” enough to allow the coil to be put in place a coil compressor can be used to compress the coil to allow fitment.
- Z. Place the Rear Coil Cup on to of the Rear Dual Rate Coil.
- AA. Install Rear Dual Rate Coils with the tightly wound coils oriented upward.
- BB. Slip the bottom of the coil onto the coil base on the axle.

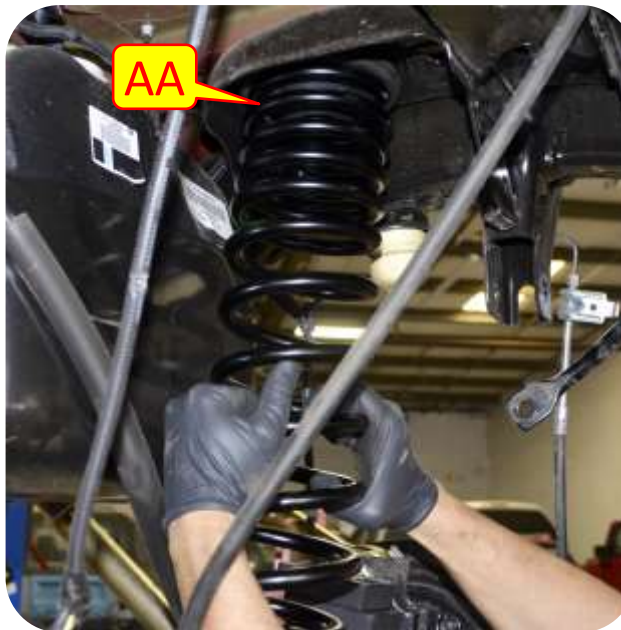
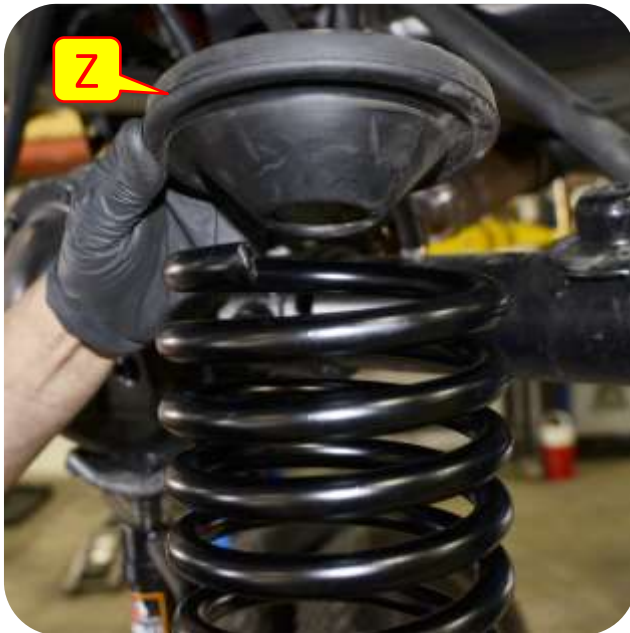

Section 3: Installation Instructions

Step 7: Install Rear Dual Rate Coils and Rear Fox Shocks

- CC. Install the Fox Rear Shocks (Part # 98224959). Using the stock hardware from removal of stock rear shock, install the Bar Pin side of the Fox Rear Shock in the upper tub side bolt hole mounts and tight bolts.
- DD. Slip the bottom shock mount into the axle mounting bracket (CC) and slide the bolt through (you may need to compress the shock to fit).
- EE. Tighten all bolts.



Section 3: Installation Instructions



Step 8: Finalize Installation

FF. Adjust the caster angle and toe as needed. Once set, tighten all hardware. Again, tighten all hardware. Finally, tighten the jam nuts on all control arms.

Step 9: Bleed Brakes

CAUTION!! FAILURE TO PROPERLY BLEED THE BRAKE LINES WILL CAUSE YOUR BRAKES TO BE INEFFECTIVE. *Before your vehicle is ready to drive you will need to refill the brake reservoir and bleed the air out of the brake lines. If you are not experienced with this process, or have any reservations, consult a professional. For a full write-up of the brake bleeding process for your JEEP Wrangler JK, you can also refer to <http://project-jk.com/jeep-jk-write-ups/jeep-jk-wrangler-maintenance-bleeding-your-brakes>.*

Section 3: Installation Instructions



Step 10: Rear Pinion Angle Adjustment *(if required)*

- GG. The Control Arm lengths given are recommended as starting points **ONLY**. Your vehicle will tell you if the pinion needs to be adjusted. When you drive the Jeep for the first time after installing the lift or after installing a new drive shaft, if you notice rear drive line vibrations, pay attention to when the vibrations occur.
- HH. If you notice vibrations during acceleration this would indicate that your pinion is too high. You can correct this condition by adjusting your rear upper control arms to a shorter length or by increasing the length of your rear lower control arms.
- II. If you notice Vibrations during Deceleration this would indicate that your pinion is too low. You can correct this condition by increasing the length of your rear upper control arms, or by adjusting the rear lower arms to a shorter length.