



PRODUCT: JK Game Changer RockSport Edition

REV: J | 03-25-2024 | II-A1225/A1235

READ INSTRUCTIONS IN FULL BEFORE INSTALLATION.

QUESTIONS? CALL 916-631-8071 M-F 7:00 AM – 5:00 PM PST

The MetalCloak experience includes the ease of installation of our products. We design for most contingencies, but installation may be different based on different Jeep condition, configuration and/or year.

We are continually trying to improve our products and instructions – please help us by providing feedback and pictures if you find any part of the instructions that do not match your particular Jeep or are not easily understandable.

If you have any difficulties at all, please give us a call. Thank you and enjoy your MetalCloak Products!

IMPORTANT NOTE: We use Stainless Steel Hardware where possible. Therefore, a tube of Silver Anti-seize is provided and should be used on all bolts—only a small amount is needed.

WARRANTY INFORMATION: This article is sold without warranty expressed or implied. No warranty or representation is made as to this products ability to protect the user from injury or death. The user assumes that risk. The effectiveness, warranty and longevity of this equipment are directly related to the manner in which it is INSTALLED, USED and/or MAINTAINED. THE USER ASSUMES ALL RISK. By purchasing this product and opening the packaging, purchasers expressly acknowledge, understand and agree that they take, select and purchase these MetalCloak products from Armored Works, LLC, its affiliates and distributors and agents as is and with all faults. The entire risk as to the quality and performance of these MetalCloak products is with the purchaser. Working on your vehicle can be a dangerous activity. If you are unsure of what you are doing, please leave mechanical or safety critical work to a skilled mechanic. We take no responsibility for the incorrect use and/or installation of MetalCloak products.

Section 1: Tools & Notes on Installation



Tools Required: This list is the recommended tools for ease of installation. Other versions of the same tool can be used. For example, Allen Wrenches instead of Allen Drive Sockets.



Socket & Ratchet Wrench

Set of SAE & Metric Sockets & Wrenches



Metal Head Hammer

Metric Hex Drive Sockets and/or Hex (Allen) Wrenches



10" Socket Extension

3/8" Flare Nut Wrench (10mm will work) for Brake Lines



Cut-Off Disc and Grinder
(Optional)

Electric Drill
1/4", 1/2", 7/16", L, 9/16 Drill Bits



HOW TO USE THIS GUIDE: The installation guide contains ALL steps for installation. Please read and follow the instructions in order of each page top to bottom, and left to right.

Jeep Model: Instructions may apply to multiple Jeep models, but are labeled separately where appropriate (i.e. TJ vs. LJ).

Options: Because of the number of component options we offer, these instructions may contain steps that will not match your particular configuration. You can skip these steps.

Images: Pictures are provided and parts are labeled throughout the instructions. Each text box contains guidance based on the pictures next to it. The text will refer to alphabetical labels (A, B, etc.) found in the images.

Installation Notes: Terms may be used in the body of the instructions that you may not be familiar with, if you have any questions feel free to contact us at the number below, or email techhelp@metalcloak.com

QUESTIONS: Any questions or comments about the instructions? Call us at 916-631-8071 M-F 7:00 AM – 5:00 PM PST.

Section 2: Installation Instructions



Important Note: MetalCloak does not recommend powder coating your True Dual Rate Coils. The baking process in powder coating can, in some cases, cause the metallurgical properties of the coils to be changed, resulting in the loss of the lift properties of the coils. As such, the process of powder coating the coils will void any warranty stated or implied in relation to the coils.

Important Note: To install lift components, you will need to fully 'droop' your suspension in the front and rear (not at the same time). We strongly recommend that the vehicle be placed on an automotive lift and that all appropriate safety precautions be taken to secure the vehicle while it is off the ground. Always use the necessary axle stands (or equivalent) to support the axle when the suspension components are disconnected for safety, and to ensure the integrity of your suspension system during the installation process.

Important Note: If using stock wheels with factory backspacing the #7104 outboard shock mount is not recommended as it will interfere with the wheel.

Important Note: MetalCloak provides "rear specific" end-links that have shorter bolt lengths that will keep for optimal fitment.

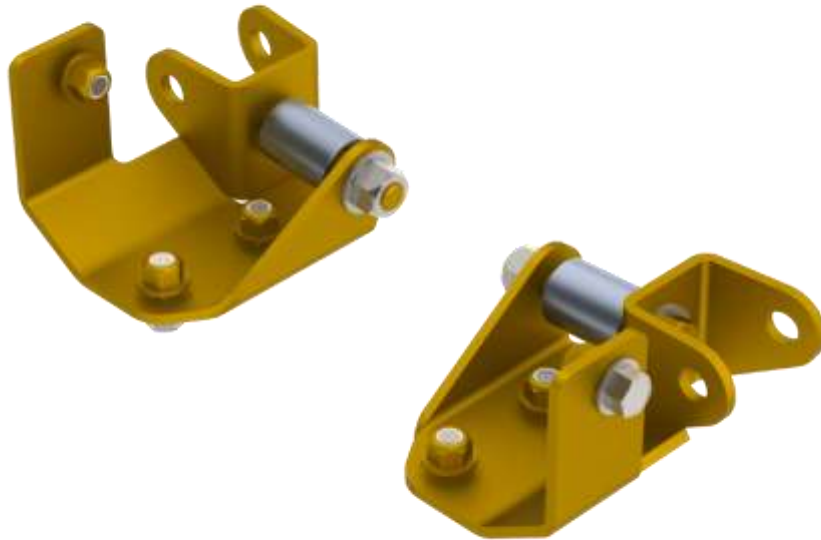

Section 3: Installation Instructions

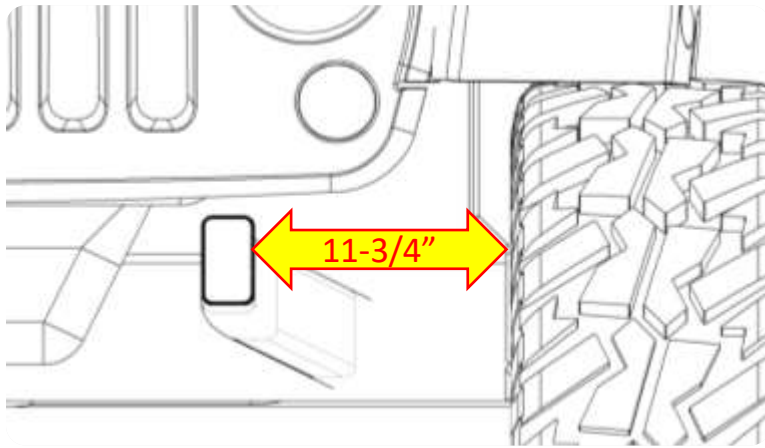

Important Note: To prevent tires from rubbing the shocks at full turn and flex, a clearance of 11-3/4" between inner wall of the tire and the outside of the frame rail is recommended. Wheel backspacing, wheel spacers, axle width and tire width can affect this value. We recommend a wheel backspacing of less than or equal to 4.0" for most common vehicle builds.

Step 1: Remove Stock Components

- Disconnect front sway bar links.
- Remove bracket located in front of lower shock mounting location that holds ABS and brake line.
- Watch the ABS and brake lines as the axle drops! Unbolt the brake line bracket from the frame and axle in case the lines are stretched while working.
- Remove the front track bar, save hardware for re-use.
- Remove sway bar end links, save the bottom bolt for use later.

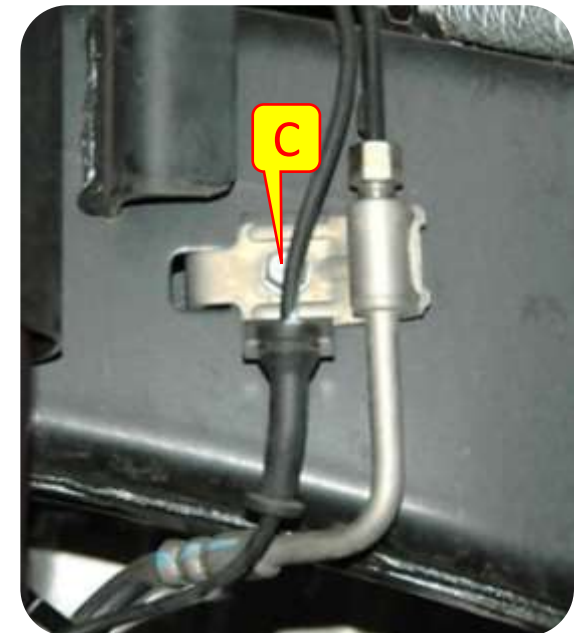
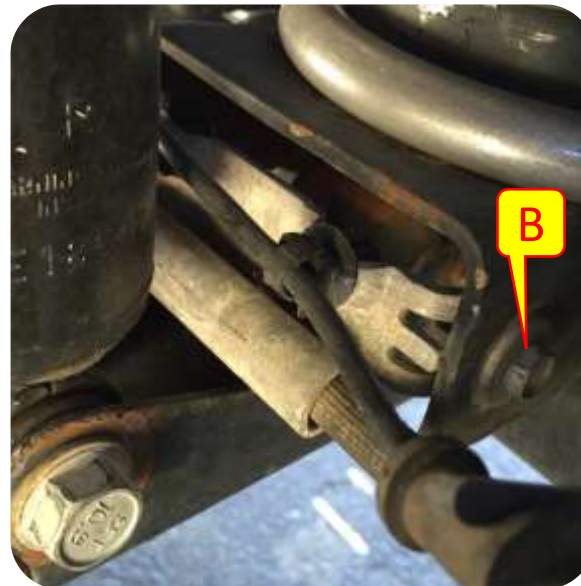

Section 3: Installation Instructions

Step 1: Remove Stock Components

- F. Use a 16MM Wrench on top and bottom to remove the stock nut on top of the upper shock mount tower.
- G. Use a 18MM Socket and Wrench to remove the stock nut and bolt from the lower shock mount bracket located on the axle.
- H. Remove stock springs, and any spacers that have been used if vehicle has been previously lifted. The rubber isolator will be re-used.

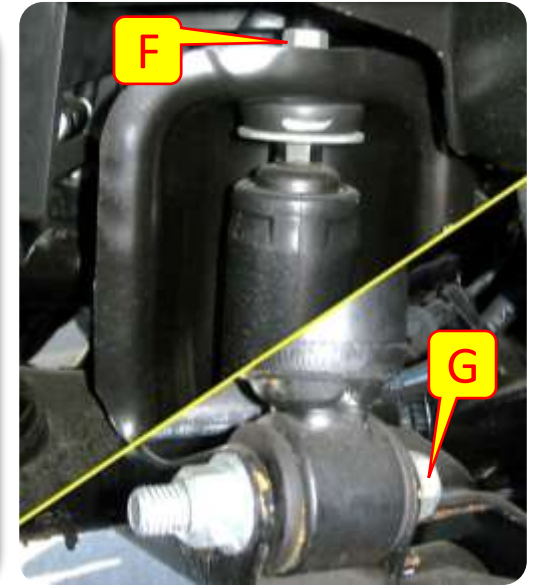

Step 2: Swap Front Control Arms

Important Note: MetalCloak ships control arms at the approximate length for 3.5" lift kits eye to eye. if you are doing a 2.5" kit, they control arms will need to be adjusted. whether 3.5" or 2.5" if you do not know the full dynamics of how to set up your control arms, please take your jeep to a professional for adjusting your caster and aligning your suspension.

		FRONT CONTROL ARMS		REAR CONTROL ARMS	
CASTOR ANGLE		UPPER	LOWER	UPPER	LOWER
FACTORY CONTROL ARMS	STOCK	22 5/8"	18 3/4"	19 3/4"	17 7/16"
METALCLOAK 2.5"/3.5" LIFT	5 DEGREES	23 1/16"	18 3/4"	20 7/16"	18 7/16"

Section 3: Installation Instructions

Step 2: Swap Front Control Arms

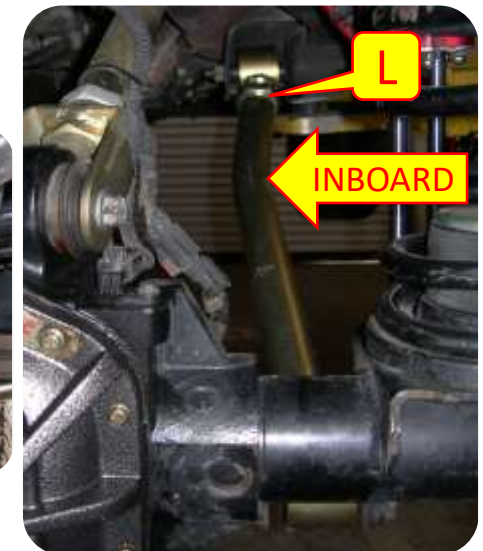
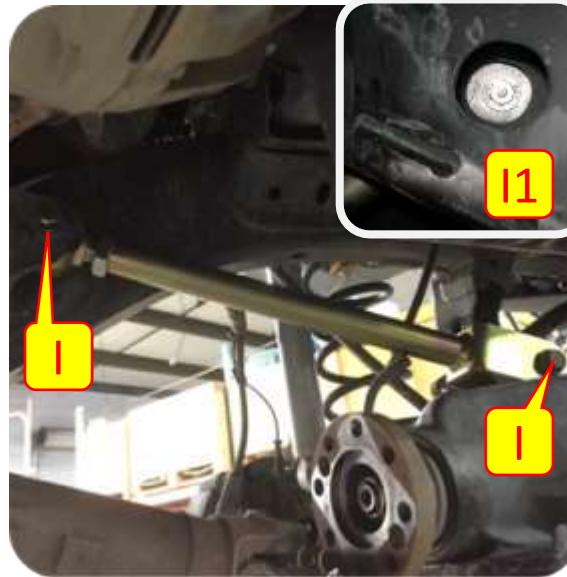

- I. Use an 18mm Socket & Wrench to remove the stock bolts from the upper control arms.
- J. The exhaust on the passenger side of some models interferes with removal of the upper bolt. Cut the stock bolt and replace it with the Flange Hex Head Bolt and Hex Flange Nut provided, install bolt from the outside of frame and the nut inside the frame. You will need a socket extension to access the head of the upper bolt inside the frame [I1].
- K. Use a 21mm Socket and Wrench to remove the stock hardware and control arms; re-use this hardware to install the MetalCloak Front Lower Control Arms.
- L. Install the Control Arms so that the short bend (*with the Lock Nut*) is in the rear, and the arm angles INBOARD to provide tire turning clearance.



Section 3: Installation Instructions

Coil Isolator Information Guide

Important Note: MetalCloak's suspension systems include a unique coil design that utilizes upper isolators to position the coil. The following table will help you identify where to install the isolators included with your kit. You must remove the stock isolators before installing the provided coil isolators. If you have any questions give us a call at 916-631-8071.

Coil Isolator Jeep Locations		
Tall Isolator	Jeep Model	Installation Locations
	JL Wrangler 3.6L Non-E Torque	Upper Front Passenger
	JL Wrangler 2.0T E-Torque	Upper Front Driver & Passenger
	JL Wrangler 4xE	Upper Front Driver & Passenger
	JL Wrangler Diesel	Upper Front Driver & Passenger
	JT Gladiator Diesel	Upper Front Driver & Passenger
Short Isolator	Jeep Model	Installation Locations
	JK Wrangler (All Models)	Upper Front Driver & Passenger
	JL Wrangler 3.6L Non-E Torque	Upper Front Driver
	JL Wrangler 3.6L E-Torque	Upper Front Driver & Passenger
	JL Wrangler Turbo	Upper Front Driver & Passenger
	JL Gladiator 3.6L Motor	Upper Front Driver & Passenger
Rear Isolator	Jeep Model	Installation Locations
	JL Wrangler 3.6L Non-E Torque	Upper Rear Passenger
	JL Wrangler 4xE	Upper Front Driver & Passenger

Section 3: Installation Instructions

Step 3: Bump Stops and Coils

- M. Droop your suspension to gain access to the spring perch. Be sure to watch the ABS lines so they do not get over extended and break.
- N. Center a Bump Stop Disk on the top of the spring perch and mark the center of the hole.
- O. Drill a hole at the marked location. You can start your hole with a smaller drill bit and work your way up to a 1/2".



Section 3: Installation Instructions

Step 3: Bump Stops and Coils

P. Select the appropriate Screw length so that the threads stick out of the bottom Disks approximately 3/4". Assemble your bump stops by feeding the 1/2" Countersunk Screw through the Cover Plate, and then threading through the Bump Stop Disks. The center hole in the Disk is intentionally small to create the most rigid assembly possible after installation.



Q. Place the assembled Bump Stop inside the spring before re-installing. Re-install the spring and place the end of the 1/2" Screw in the drilled hole.



R. The 1/2" Screw is backed by a 1/2" Flanged Nylon Lock Nut. Install the nut and tighten the hardware using a 5/16" Hex Key Socket or Allen Wrench and a 3/4" Wrench. Tighten until everything is tight; the hardware will not bottom out, but instead will begin to compress the Disks.

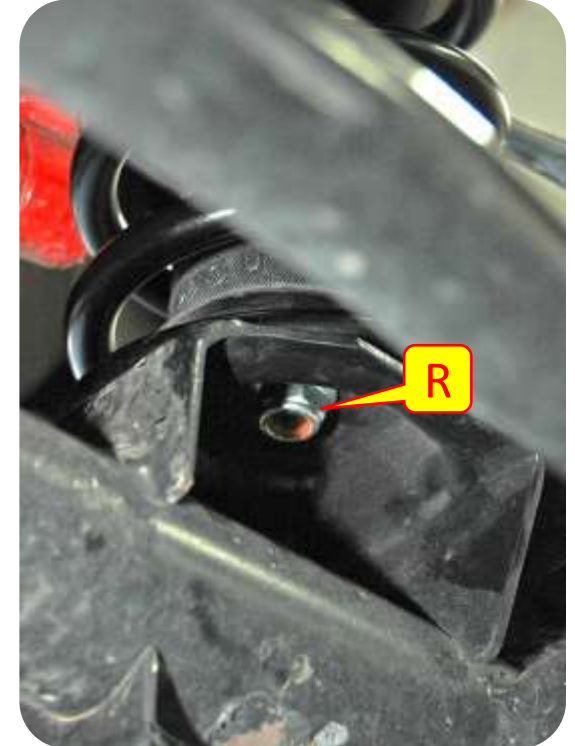

Important Note: *The bump stops may also be assembled inside the coil springs after they are installed.*

Section 3: Installation Instructions



Step 3: Bump Stops and Coils

- S. If the axle does not “droop” enough to allow the coil to be put in place a coil compressor can be used to compress the coil to allow fitment.
- T. Install Front Dual Rate Coils with the tightly wound coils oriented upward.
- U. Slip the bottom of the coil onto the coil base on the axle.

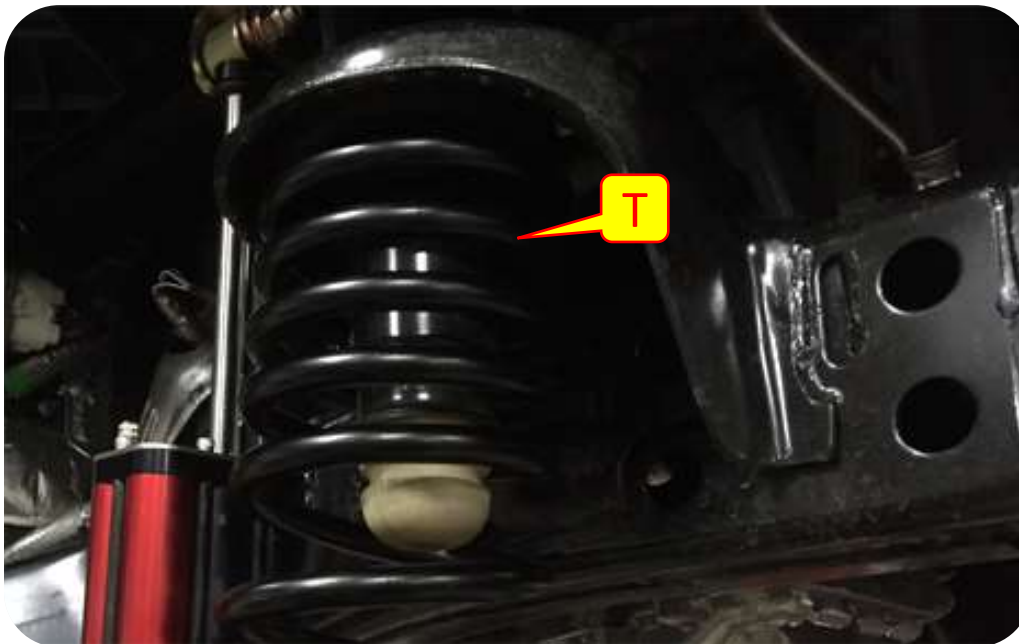

Section 3: Installation Instructions

Step 4: Shock & Shock Bracket Installation

Important Note: If using stock wheels with factory backspacing the outboard shock mount is not recommended as it will interfere with the wheel.

- V. Slide the stock shock bracket into the outboard shock spacer making sure the holes align.
- W. Mark the hole located on the bottom of the shock mount.
- X. Drill out all three holes using a 3/8" drill bit.

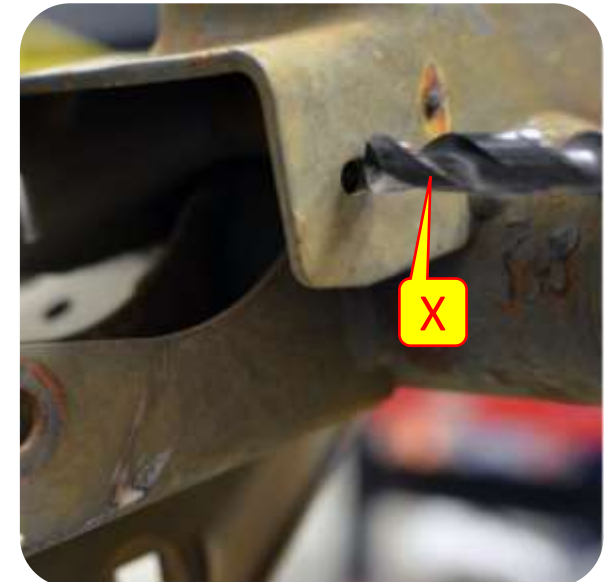
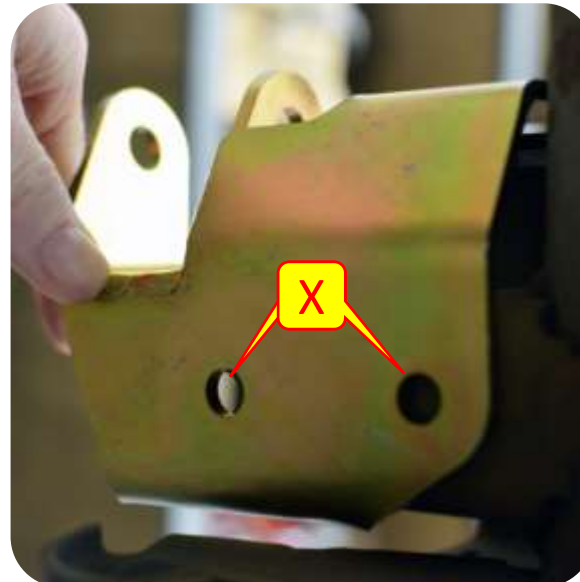
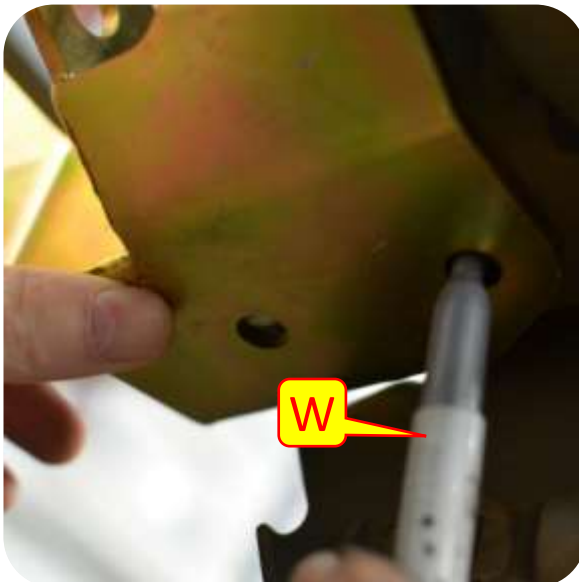
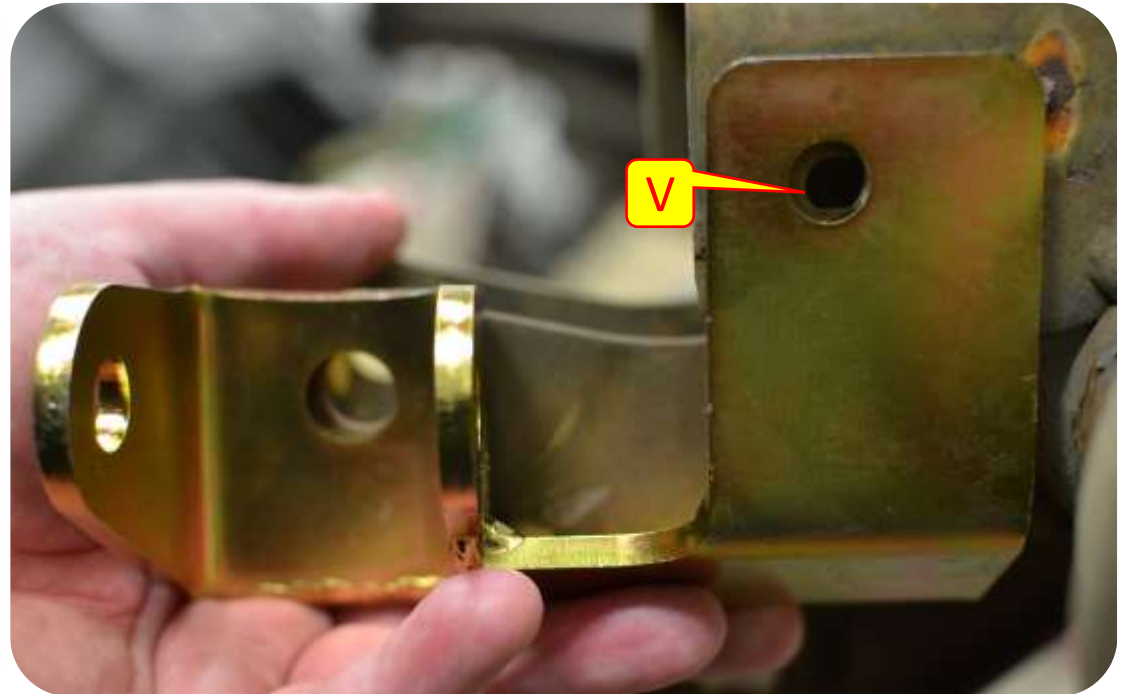

Section 3: Installation Instructions

Step 4: Shock & Shock Bracket Installation

Y. Install 2 bottom bolts hand tight.

Z. Install the side bolt hand tight

AA. Insert the spacer in the space between the stock shock mount.

BB. Install spacer bolt and washers.

CC. Tighten all hardware.

Flange Bolts – 14MM Socket & Wrench

Hex Bolts – 19MM Socket & Wrench

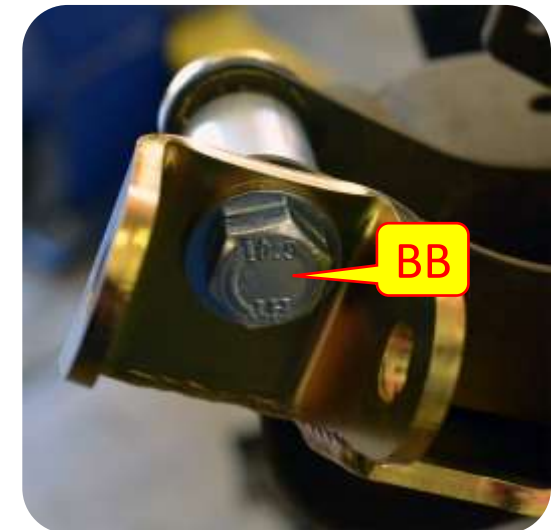
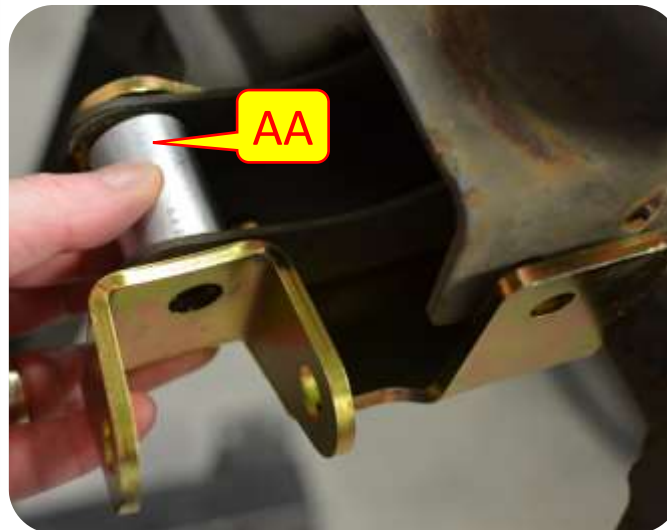
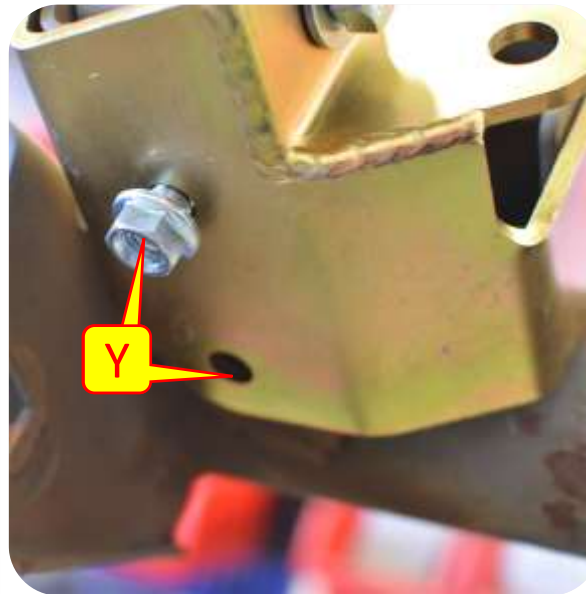

Section 3: Installation Instructions

Step 4: Shock & Shock Bracket Installation

DD. Remove one nut, washer and rubber spacer from the top of the RockSport shock.

EE. Slip the top of the front shock into the shock tower.

FF. Place the rubber spacer, washer, and nut back onto the top of the shock. And using a 19mm wrench tighten the shock nut to torque specs (*20ft. Lbs*).

GG. Slip the bottom of the front shock into the New shock bracket.

HH. Slide the stock bolt into place and tighten the bottom shock nut hand tight.

II. Using a 18mm socket and wrench tighten down the shock bolt to torque specs (*56ft. Lbs*).

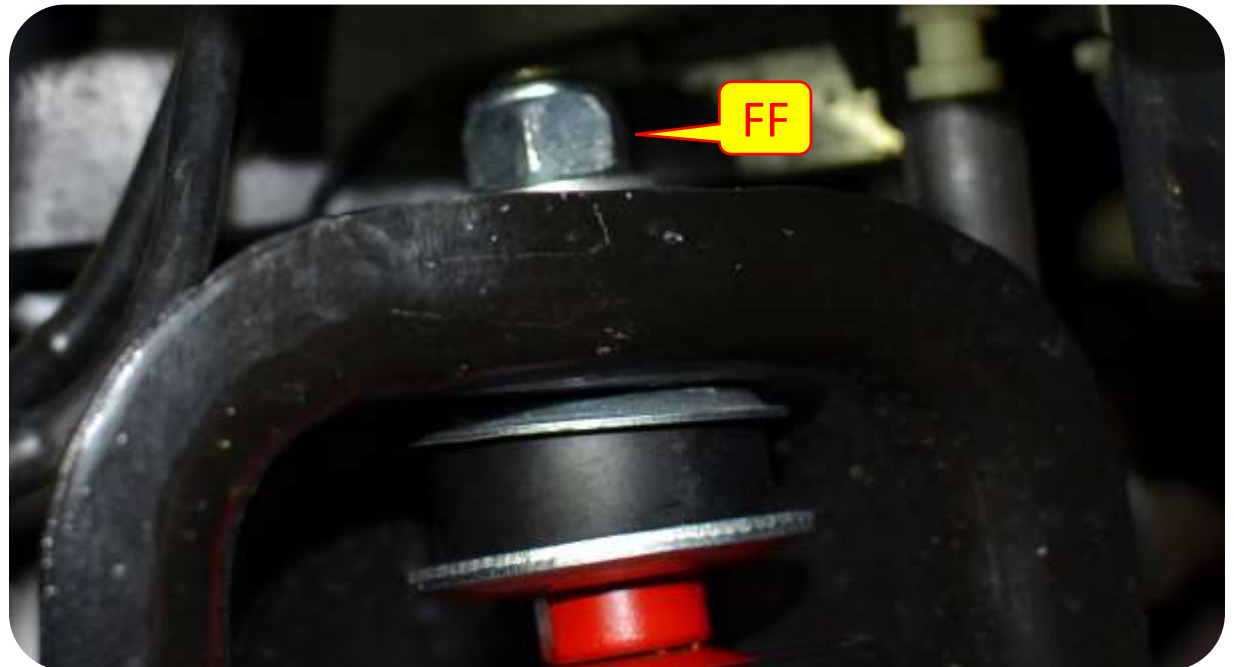

Section 3: Installation Instructions

Step 5: Install Front Brake Lines

Note: Place a drain pan/fluid catch under caliper; fluid will leak out when removing brake lines.

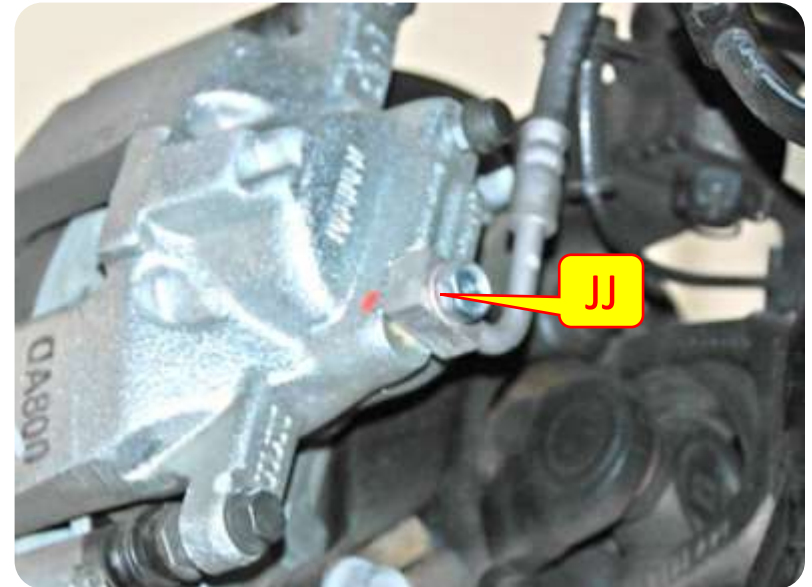

- JJ. Use a 15mm Socket to remove the 'banjo' bolt from the brake calipers. You will want a drain pan to catch the brake fluid.
- KK. Unclip the ABS line from the brake line (*all the way down*), Use a 10mm Socket to remove the bolt holding the stock bracket. Remove the frame clip and discard.
- LL. Use a 12mm Wrench to unscrew the stock brake line from the frame bracket.

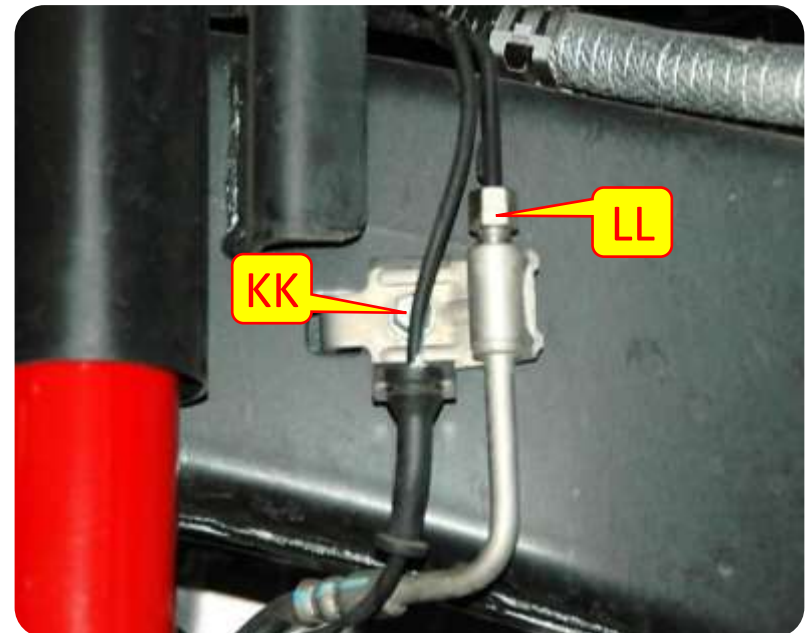

Section 3: Installation Instructions

Step 5: Install Front Brake Lines

MM. Place the L-bracket on the frame in the factory location using the factory hardware.

NN. Install the 24-1/2" Brake Line through the bracket.

OO. Screw the stock line into the new Brake Line and tighten using a 12mm and 17mm Wrench.

PP. Install the provided Spring Clip to retain the Brake Line in the Bracket. You may need a hammer to lightly tap this clip into place.

QQ. Use a 1/2" Socket to install the 5/16"-18 Hex Head Self-Tapping Screw. Do not fully tighten.

RR. Feed the banjo bolt through the square end of the brake line. Use the provided brass washers on both sides of the brake line as shown.

SS. Re-install the banjo bolt into the brake caliper.

TT. Zip-tie the ABS lines to the new brake lines.

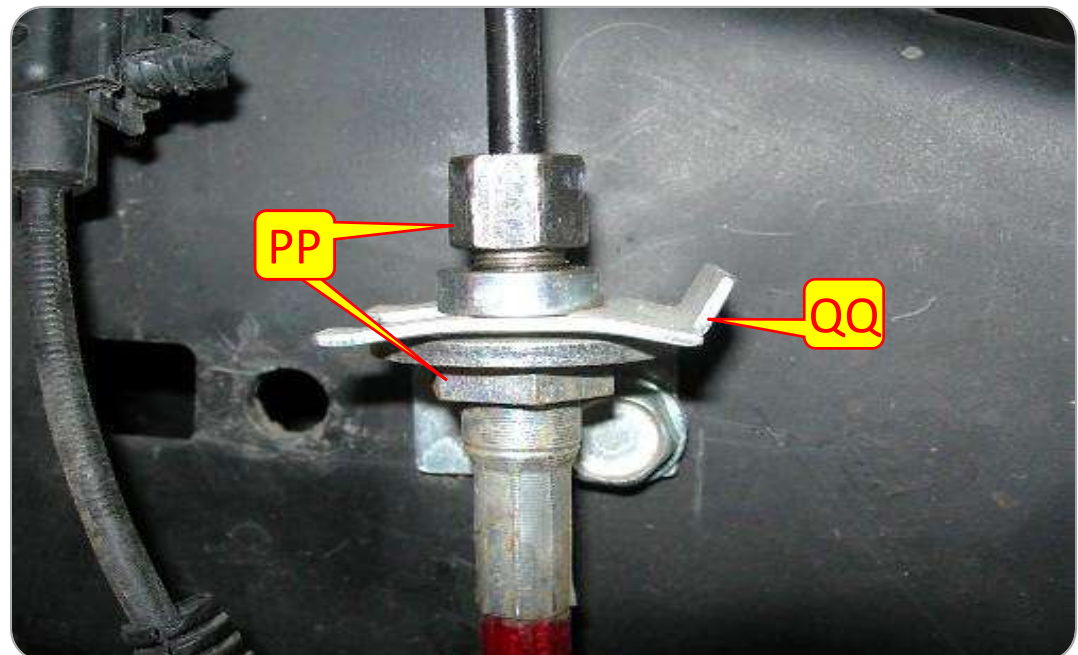

Section 3: Installation Instructions



Step 6: Bleed Brakes

CAUTION!! FAILURE TO PROPERLY BLEED THE BRAKE LINES WILL CAUSE YOUR BRAKES TO BE INEFFECTIVE. Before your vehicle is ready to drive you will need to refill the brake reservoir and bleed the air out of the brake lines. If you are not experienced with this process, or have any reservations, consult a professional. For a full write-up of the brake bleeding process for your JEEP Wrangler JK, you can also refer to <http://project-jk.com/jeep-jk-write-ups/jeep-jk-wrangler-maintenance-bleeding-your-brakes>.

Section 3: Installation Instructions

Step 7: Front Track Bar

UU. The fixed end of the MetalCloak JK Front Track Bar goes in the stock frame bracket. The clearance bends should point toward the front bumper, up and away from the differential cover. Re-use the stock hardware, and only hand tighten the hardware for now (*you will fully tighten everything at the end*).



VV. The adjustable end of the Track Bar goes into the stock bracket on the axle, again re-using the stock hardware. With the full weight of the vehicle on the springs, push the bolt through the bracket and the Track Bar joint.

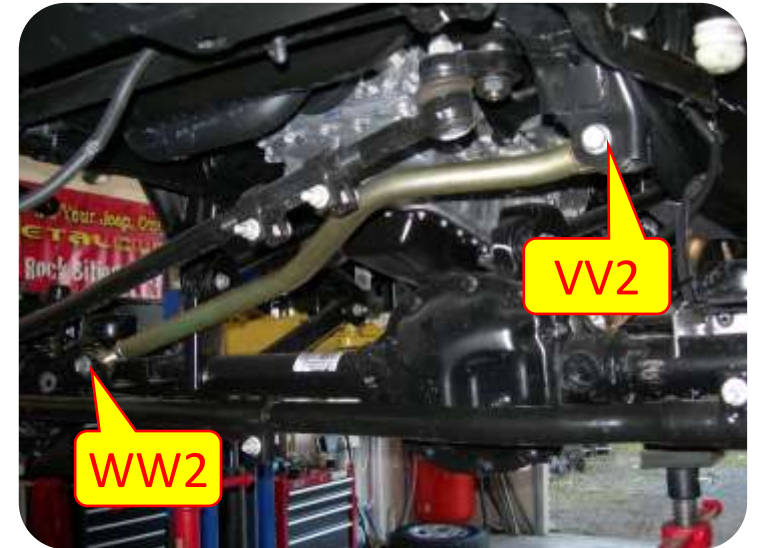

WW. Fully tighten the stock hardware on both ends of the Track Bar, and then tighten the Jam Nut on the Track Bar.

XX. MetalCloak **STRONGLY RECOMMENDS** having your alignment checked by a professional after changing any suspension components.

Note: *It is helpful to have someone push the vehicle to the driver or passenger side to help align the hole; if you don't have an extra pair of hands, you can use a ratchet strap on the frame/axle to pull the frame in the desired direction. Make sure the axle is centered. If not then remove the bolt, adjust the Track Bar length, replace the bolt, and re-check axle centeredness. Repeat until the axle is as close to center.*

Section 3: Installation Instructions

Step 8: Install Sway Bar Links

YY. Install the lower quick disconnect pin in the stock location. Point the pin toward the center of the vehicle, backed by the provided $\frac{1}{2}$ "-13 hardware. A screwdriver through the hole on the end of the pin is helpful while tightening the nut with a $\frac{3}{4}$ " wrench.

ZZ. Assemble the sway bar link by threading a jam nut onto the lower link.

AAA. Now thread the link into the ball joint. Set the length to 12.25". Do not tighten Jam nut yet.

BBB. Install the ball joint on the outside of the sway bar end. You will need a thin $\frac{9}{16}$ " box end wrench to keep the ball joint from turning while you tighten the nut with a $\frac{5}{8}$ " wrench.

Important Note:
MetalCloak recommends using red Loctite on each of the upper spindles of the sway bar end links.

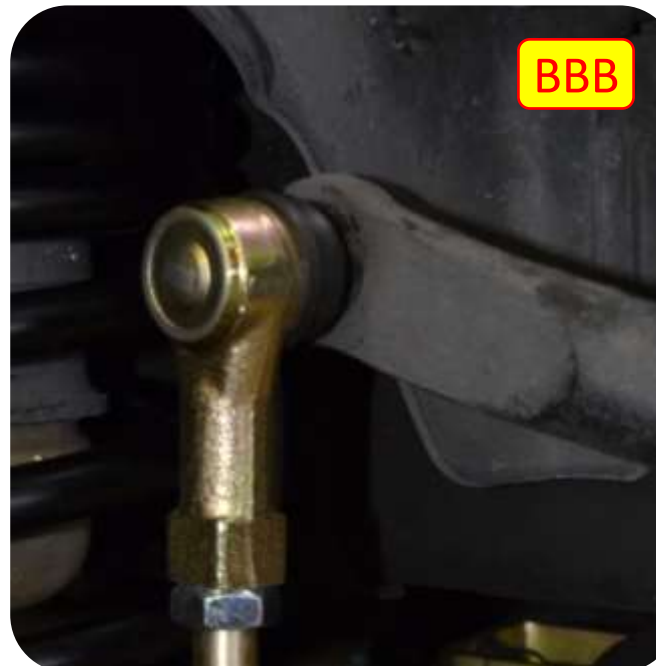

Section 3: Installation Instructions

Step 8: Install Sway Bar Links

CCC. Installed lower rubber bushing on the quick disconnect pin.

DDD. Tighten the jam nut.

EEE. Disconnect the links and align the provided brackets in the desired location. There is no exact location; the goal is simply to keep the sway bar clear of the tires when stowed. Mark the locations and drill with a 9/32" drill bit. Install the self-tapping screws through the bracket using a 1/2" wrench.

FFF. Re-attach the links to the lower pins and install the 1/4" Locking Pins. These may be snug against the rubber bushing, so don't be surprised if you need to use a little muscle to push them through.

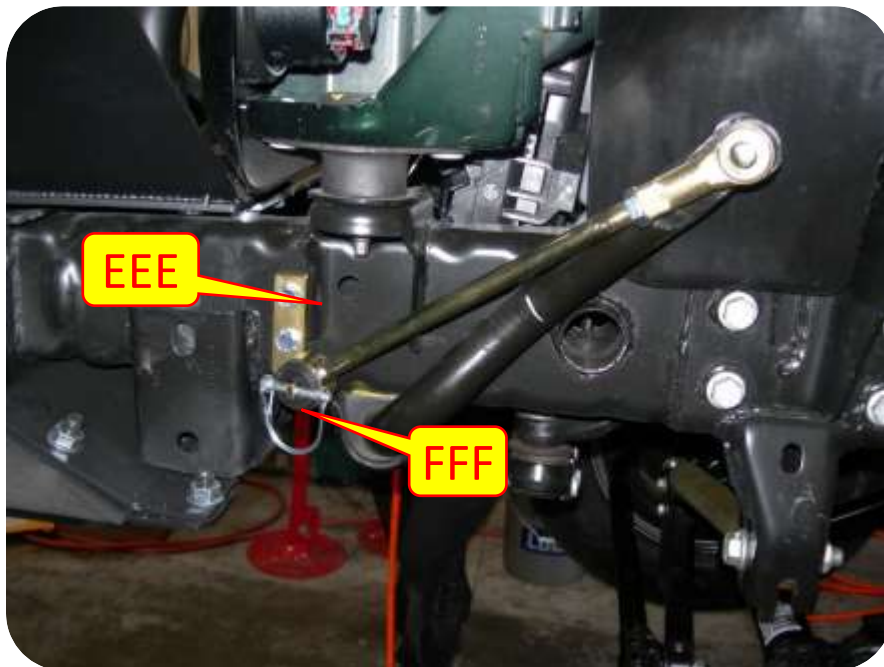

Section 3: Installation Instructions



Step 9: Finalize Installation

GGG.Adjust the caster angle and toe as needed. Once set, tighten all hardware. Finally, tighten the jam nuts on all control arms.

Note: *When lifting any vehicle, basic dynamics are changed. It is important for you to take your vehicle to a professional for alignment after installation. When doing so, make sure he is setting caster for lifted vehicle (not stock specs).*

Section 3: Installation Instructions

Step 1: Remove Stock Components

- A. Disconnect rear sway bar links. Save the lower bolt for later use.
- B. Disconnect rear brake lines. Go ahead and replace the brake lines at this time (*See Page 20*).
- C. Remove the rear track bar. Save the upper bolt for later use.
- D. Remove the shocks.
- E. Remove stock springs, and any spacers that have been used if vehicle has been previously lifted. The rubber isolator will be re-used.



Section 3: Installation Instructions

Step 2: Install Rear Brake Lines

- F. The steps to replace the rear brake lines are essentially identical to the front. Use the M6 screw to install the L-Bracket in the stock location, and then install the Brake Line following the same steps as the front.



CAUTION!! FAILURE TO PROPERLY BLEED THE BRAKE LINES WILL CAUSE YOUR BRAKES TO BE INEFFECTIVE.

Before your vehicle is ready to drive you will need to refill the brake reservoir and bleed the air out of the brake lines. If you are not experienced with this process, or have any reservations, consult a professional. For a full write-up of the brake bleeding process for your JEEP Wrangler JK, you can also refer to <http://project-jk.com/jeep-jk-write-ups/jeep-jk-wrangler-maintenance-bleeding-your-brakes>.



Section 3: Installation Instructions

Step 3: Install Rear Control Arms

- G. Use a 21mm socket and wrench to remove the stock hardware and control arms; re-use this hardware to install MetalCloak rear control arms. The Lock Nuts should be towards the front, at the frame mount for both upper and lower control arms.
- H. The MetalCloak rear upper arm should be oriented so that the bend in the arm angles inboard to provide tire clearance.
- I. Install track bar bracket before completing the install of the lower control arm on the driver side.

		FRONT CONTROL ARMS		REAR CONTROL ARMS	
CASTOR ANGLE		UPPER	LOWER	UPPER	LOWER
FACTORY CONTROL ARMS	STOCK	22 5/8"	18 3/4"	19 3/4"	17 7/16"
METALCLOAK 2.5"/3.5" LIFT	5 DEGREES	23 1/16"	18 3/4"	20 7/16"	18 7/16"

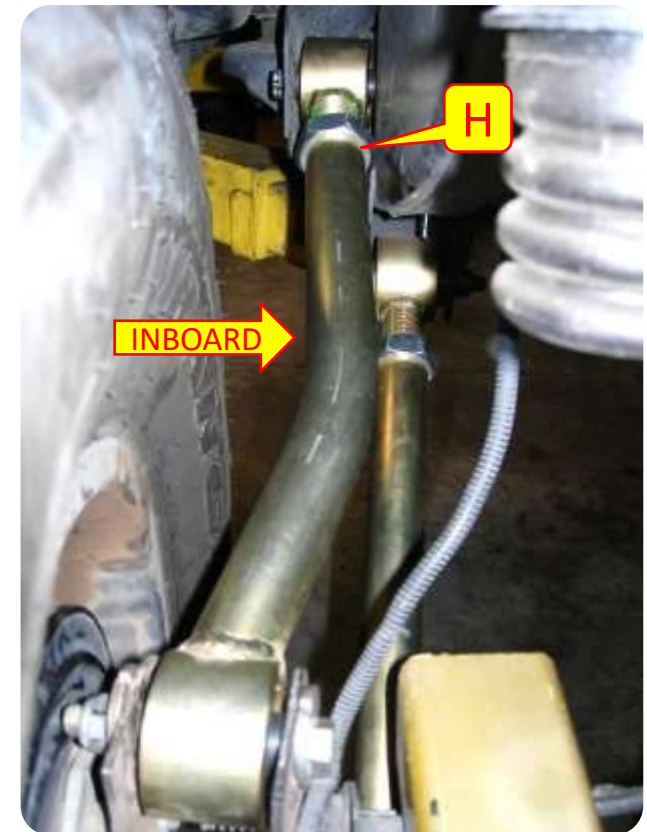

Important Note: MetalCloak ships control arms at the approximate length for 3.5" lift kits eye to eye. if you are doing a 2.5" kit, they control arms will need to be adjusted. whether 3.5" or 2.5" if you do not know the full dynamics of how to set up your control arms, please take your jeep to a professional for adjusting your caster and aligning your suspension.



Section 3: Installation Instructions

Step 4: Install MetalCloak Track Bar Bracket

- J. Slide the MetalCloak Track Bar Bracket in place as shown and re-install the stock bolt through the control arm; do not fully tighten any hardware until the Bracket is fully installed.
- K. Insert the provided Spacer in the axle bracket where the stock track bar was mounted.
- L. Install the provided M14-2x100mm" Hex Cap Screw through the stock hole with a Washer under the head of the Screw.
- M. The Screw is backed by a M14" Nylon Jam Lock Nut and Washer; install but do not fully tighten.

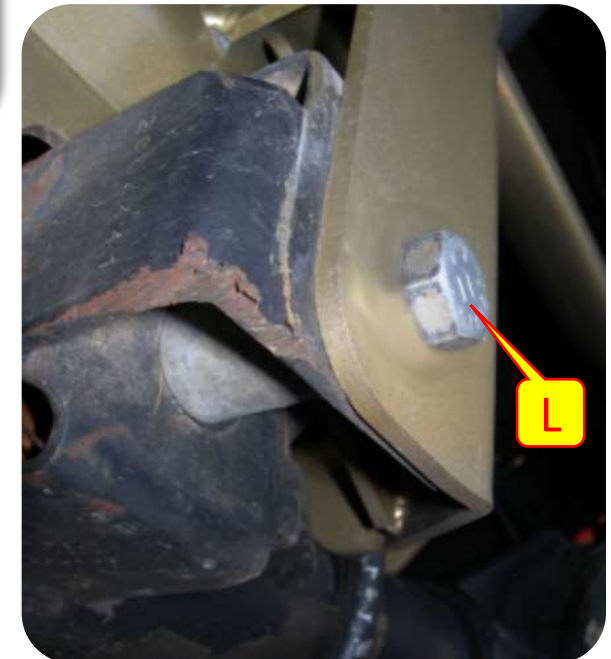
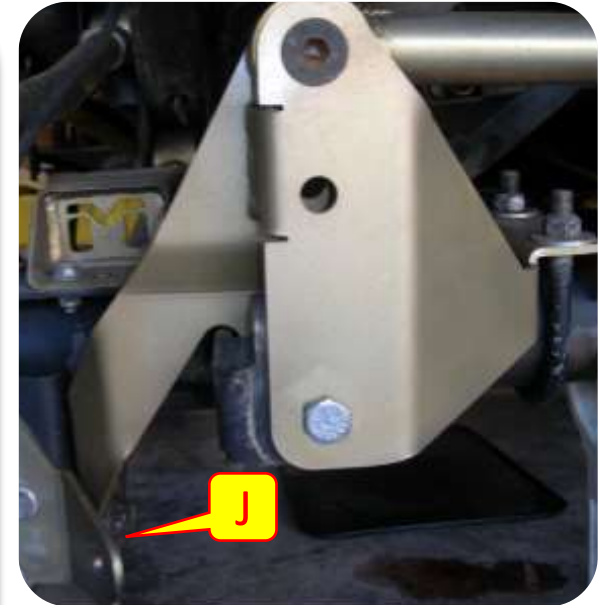

Section 3: Installation Instructions



Step 4: Install MetalCloak Track Bar Bracket

- N. Use a 3/4" Socket to install the 1/2"-20 U-bolt with the provided 1/2"-20 Flange Lock Nuts. You can snug all the Bracket hardware at this time, but do not fully tighten.



Step 5: Install MetalCloak Track Bar

- O. Pre-set the length of the MetalCloak Track Bar to 40-1/8" eye-to-eye. This length can be adjusted for your specific build.
- P. Install the MetalCloak Track Bar using the stock hardware. On the bottom the BOLT HEAD should face REARWARD, and on the upper mount the NUT should be to the rear. Tighten all hardware.

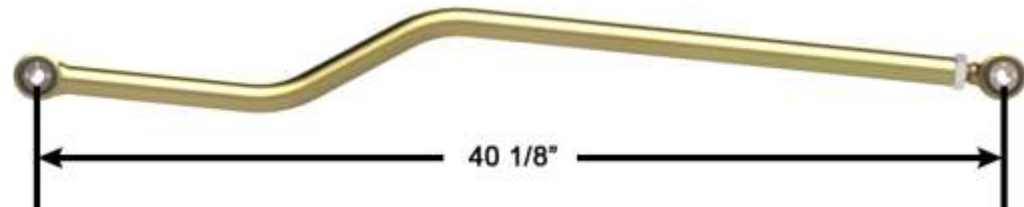

Section 3: Installation Instructions

Step 6: Install Rear Coils

- Q. If the axle does not “droop” enough to allow the coil to be put in place a coil compressor can be used to compress the coil to allow fitment.
- R. Place the Rear Coil Cup on top of the Rear Dual Rate Coil.
- S. Install Rear Dual Rate Coils with the tightly wound coils oriented upward.
- T. Slip the bottom of the coil onto the coil base on the axle.



Section 3: Installation Instructions

Step 7: Install Rear Shocks

- U. Install the upper rear RockSport shocks into the stock shock location. Using a 16MM socket tighten the upper shock stock hardware to torque specs (*37ft. Lbs*).



Section 3: Installation Instructions

Step 7: Install Rear Shocks

- V. Lower the Jeep to the ground so that the shock bracket is close enough to slip the bottom of the shock into place.
- W. Place the bottom of the rear shock into the stock shock bracket.
- X. Slide the stock bolt through the shock bracket and rear shock.
- Y. Tighten the stock hardware hand tight.
- Z. Using a 18mm socket and wrench tighten the lower shock bolt to torque specs (56ft. lbs).



Section 3: Installation Instructions

Step 8: Sway Bar Drop (Option 1 - 7026)

- AA. Disconnect the sway bar end links at the axle
- BB. Remove the sway bar from the JK so that it no longer sits above the stock exhaust.
- CC. Re-use the stock hardware to screw the drop bracket to the frame in the stock location. The bracket should be roughly vertical.
- DD. Using the provided hardware use a 14mm or 9/16" hex socket or wrench to bolt the sway bar to the bottom of the drop bracket .
- EE. Re-attach the stock sway bar links.

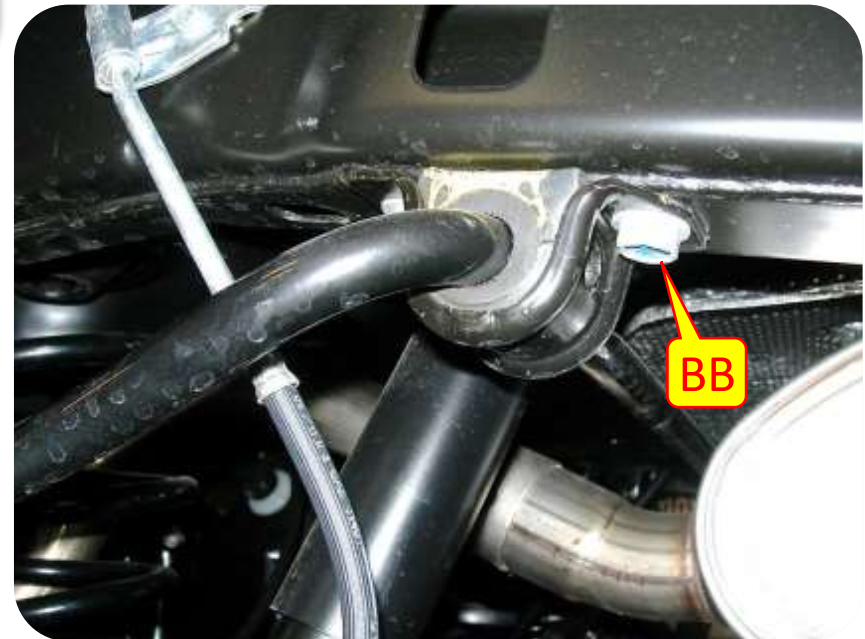
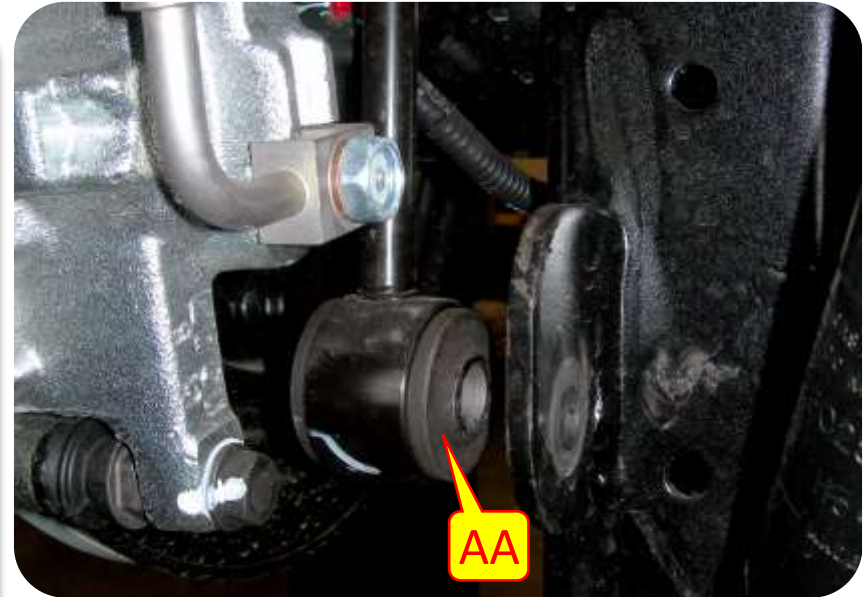

Section 3: Installation Instructions

Step 8: Install Rear Sway Bar Drop Spacer (Option 2 – 7027)

FF. If you intend to replace your sway bar links with longer links, disconnect links on both ends.

GG. Remove stock hardware from sway bar mounts.

HH. Slide the sway bar to the rear or set aside.

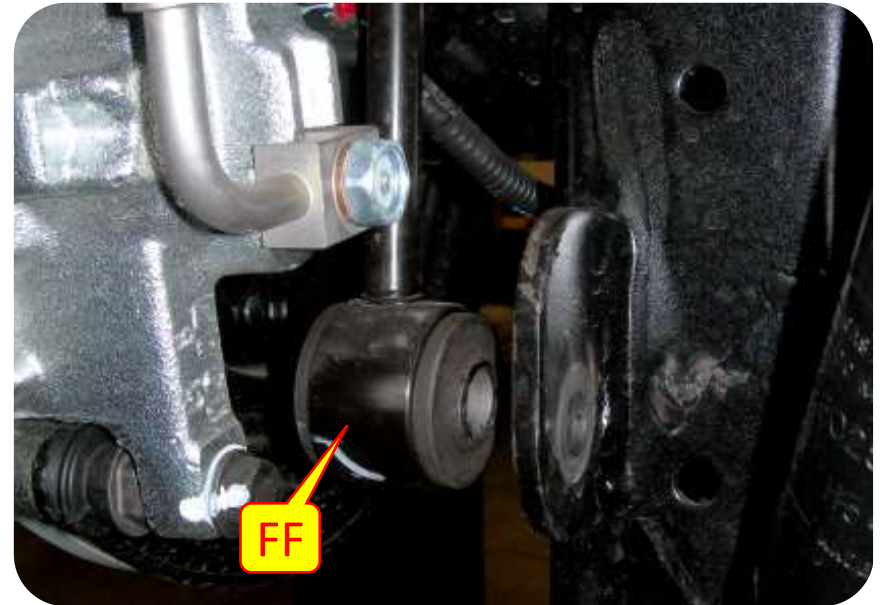

Section 3: Installation Instructions

Step 8: Install Rear Sway Bar Drop Spacer (Option 2 – 7027)

- II. Screw the provided M10 Screws through the drop spacer into the frame in the stock location. The tapped holes sit to the rear of the counter board holes.
- JJ. Use the provided Flange Bolts hardware use a 14mm or 9/16" hex socket or wrench to bolt the sway bar to the spacer.
- KK. Attach (or re-attach) extended Sway Bar Links.

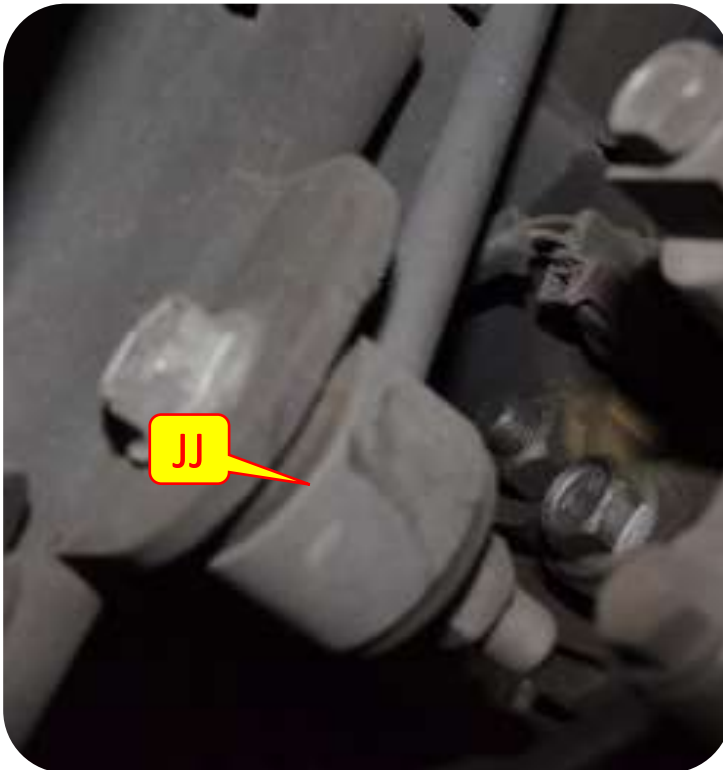
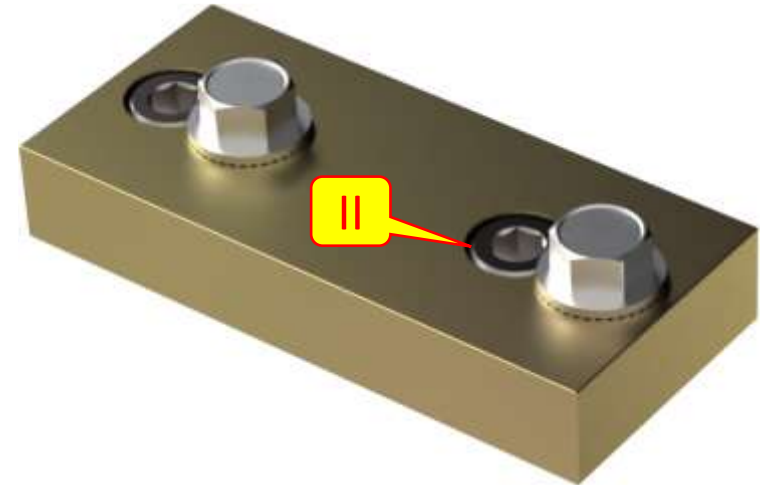

Section 3: Installation Instructions



Step 8: Install Rear Sway Bar Drop Spacer (Option 2 – 7027)

LL. Using the factory hardware install the bottom of the MetalCloak extended sway bar links.

MM. Using the factory hardware install the top of the MetalCloak extended sway bar links.

NN. Torque upper and lower bolts to 75lbs.

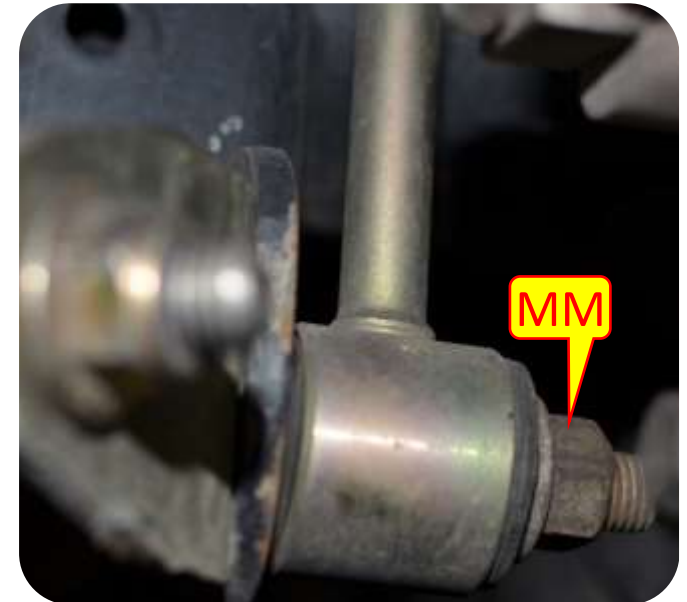
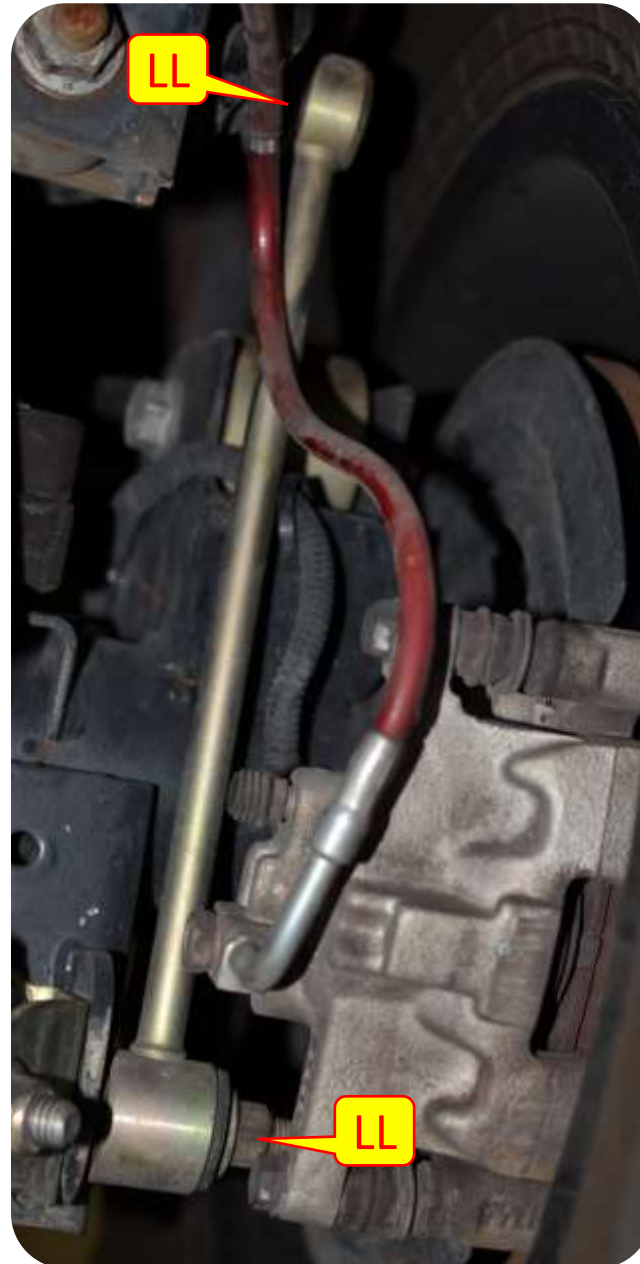

Section 3: Installation Instructions

Step 9: Install Rear Bump Stops

OO. Driver Side Bump Stop Holes.

PP. Passenger Side Bump Stop Holes.

QQ. Diagram showing the two sides of the Bump Stops.

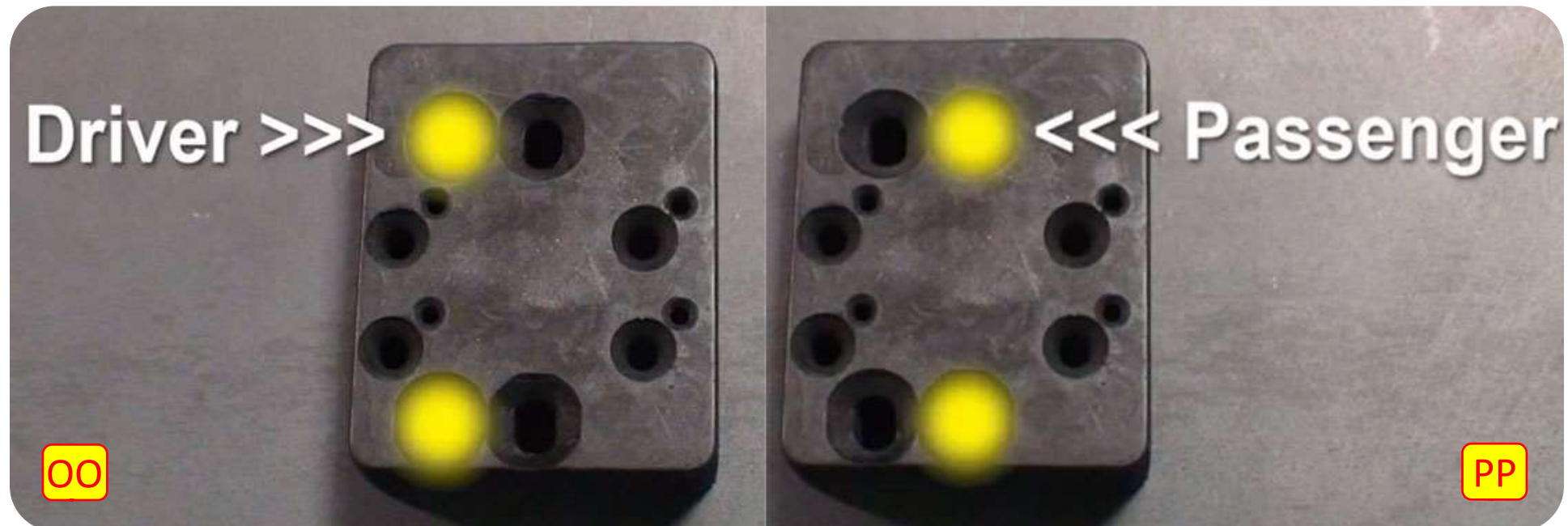
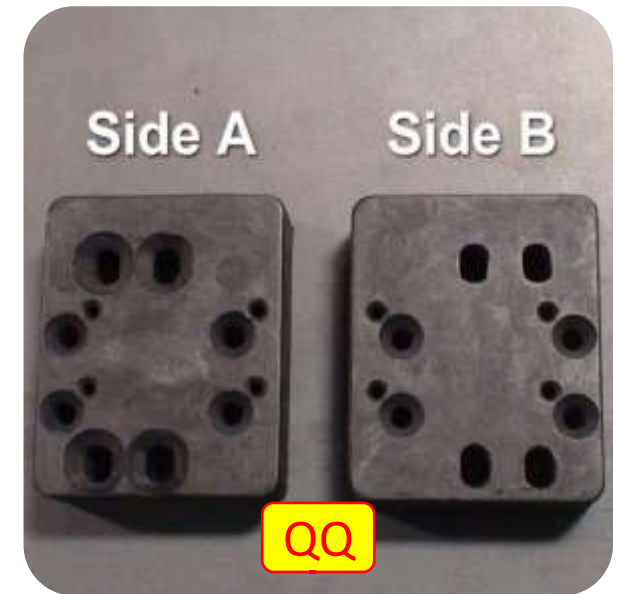

Section 3: Installation Instructions

Step 9: Install Rear Bump Stops

- RR. Install first bump stop puck (Side A) using the correct holes (shown in step A and B) using the 5/16 bolt with the matching nut and washer.
- SS. Install next puck (Side B) using the 1 3/4" woodscrews.
- TT. Continue until desired bump stop height (Side A/Side B/ Side A/Side B).



Section 3: Installation Instructions



Step 10: Bleed Brake Lines

Important Note: *Before driving bleed brake lines.*

