



PRODUCT: 5.5" Game Changer Suspension, 6Pak Edition

REV: F | 04-04-2024 | II-A1255

**READ INSTRUCTIONS IN FULL BEFORE INSTALLATION.
QUESTIONS? CALL 916-631-8071 M-F 7:00 AM – 5:00 PM PST**

The MetalCloak experience includes the ease of installation of our products. We design for most contingencies, but installation may be different based on different Jeep condition, configuration and/or year.

We are continually trying to improve our products and instructions – please help us by providing feedback and pictures if you find any part of the instructions that do not match your particular Jeep or are not easily understandable.

If you have any difficulties at all, please give us a call. Thank you and enjoy your MetalCloak Products!

IMPORTANT NOTE: We use Stainless Steel Hardware where possible. Therefore, a tube of Silver Anti-seize is provided and should be used on all bolts—only a small amount is needed.

WARRANTY INFORMATION: This article is sold without warranty expressed or implied. No warranty or representation is made as to this products ability to protect the user from injury or death. The user assumes that risk. The effectiveness, warranty and longevity of this equipment are directly related to the manner in which it is INSTALLED, USED and/or MAINTAINED. THE USER ASSUMES ALL RISK. By purchasing this product and opening the packaging, purchasers expressly acknowledge, understand and agree that they take, select and purchase these MetalCloak products from Armored Works, LLC, its affiliates and distributors and agents as is and with all faults. The entire risk as to the quality and performance of these MetalCloak products is with the purchaser. Working on your vehicle can be a dangerous activity. If you are unsure of what you are doing, please leave mechanical or safety critical work to a skilled mechanic. We take no responsibility for the incorrect use and/or installation of MetalCloak products.

Section 1: Tools & Notes on Installation

Tools Required: This list is the recommended tools for ease of installation. Other versions of the same tool can be used. For example, Allen Wrenches instead of Allen Drive Sockets. Be sure to use metric on metric and SAE on SAE.



Socket & Ratchet Wrench

Set of SAE & Metric Sockets & Wrenches



Metal Head Hammer

Metric Hex Drive Sockets and/or Hex (Allen) Wrenches



10" Socket Extension

3/8" Flare Nut Wrench (10mm will work) for Brake Lines



Cut-Off Disc and Grinder
(Optional)

Electric Drill
1/4", 1/2", 7/16", L, 9/16", 7/8" Drill Bits



HOW TO USE THIS GUIDE: The installation guide contains ALL steps for installation. Please read and follow the instructions in order of each page top to bottom, and left to right.

Jeep Model: Instructions may apply to multiple Jeep models, but are labeled separately where appropriate (i.e. TJ vs. LJ).

Options: Because of the number of component options we offer, these instructions may contain steps that will not match your particular configuration. You can skip these steps.

Images: Pictures are provided and parts are labeled throughout the instructions. Each text box contains guidance based on the pictures next to it. The text will refer to alphabetical labels (A, B, etc.) found in the images.

Installation Notes: Terms may be used in the body of the instructions that you may not be familiar with, if you have any questions feel free to contact us at the number below, or email techhelp@metalcloak.com

QUESTIONS: Any questions or comments about the instructions? Call us at 916-631-8071 M-F 7:00 AM – 5:00 PM PST.

Section 3: Installation Instructions



Important Note: MetalCloak does not recommend powder coating your True Dual Rate Coils. The baking process in powder coating can, in some cases, cause the metallurgical properties of the coils to be changed, resulting in the loss of the lift properties of the coils. As such, the process of powder coating the coils will void any warranty stated or implied in relation to the coils.

Important Note: To install lift components you will need to fully 'droop' your suspension in the front and rear (not at the same time). We strongly recommend that the vehicle be placed on an automotive lift and that all appropriate safety precautions be taken to secure the vehicle while it is off the ground. Always use the necessary axle stands (or equivalent) to support the axle when the suspension components are disconnected for safety, and to ensure the integrity of your suspension system during the installation process.

Important Note: All shocks are marked on the shock plate to identify the shocks corresponding location.

JKF – Front Shocks

JKRD – Rear Driver Side Shock

JKRP – Rear Passenger Side Shock



Section 3: Installation Instructions

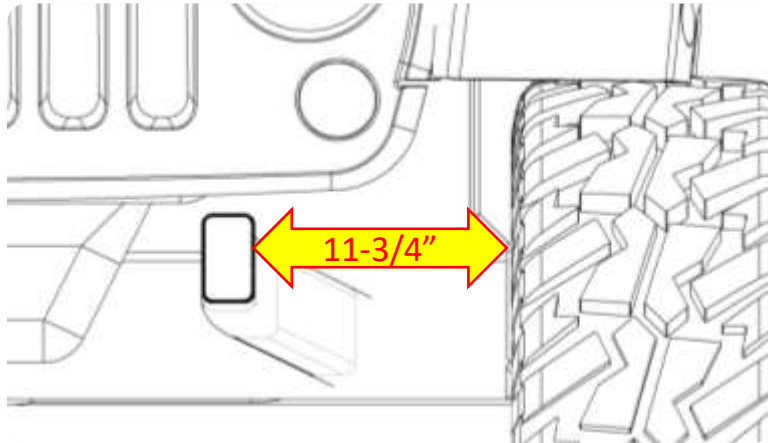

Important Note: To prevent tires from rubbing the shocks at full turn and flex, a clearance of 11-3/4" between inner wall of the tire and the outside of the frame rail is recommended. Wheel backspacing, wheel spacers, axle width and tire width can effect this value. We recommend a wheel backspacing of less than or equal to 4.0" for most common vehicle builds.

Step 1: Remove Stock Components

- A. Disconnect front sway bar links.
- B. Watch the ABS and brake lines as the axle drops! Unbolt the brake line bracket from the frame and axle in case the lines are stretched while working.
- C. Remove the front track bar, save hardware for re-use.
- D. Remove sway bar end links, save the bottom bolt for use later.

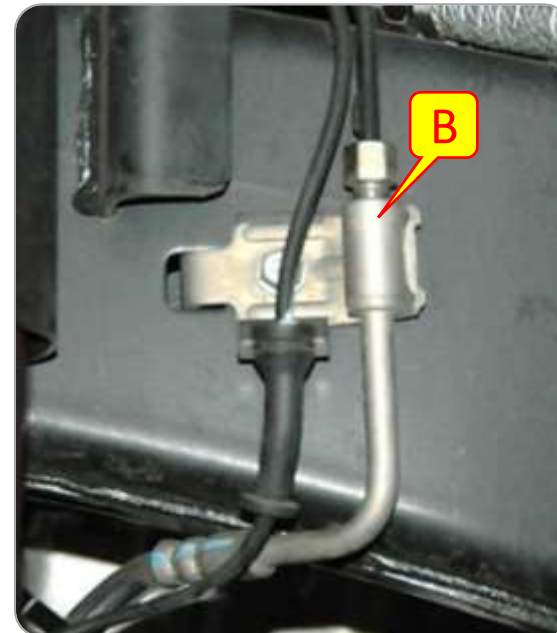

Section 3: Installation Instructions

Step 1: Remove Stock Components

- E. Use a 16MM Wrench on top and bottom to remove the stock nut on top of the upper shock mount tower.
- F. Use a 18MM Socket and Wrench to remove the stock nut and bolt from the lower shock mount bracket located on the axle.
- G. Remove stock springs, and any spacers that have been used if vehicle has been previously lifted. The rubber isolator will be re-used.



Section 3: Installation Instructions

Step 2: Front Drop Bracket

- A. Use a 21mm socket and wrench to remove the stock hardware and front control arms. Save all hardware.
- B. Slide the drop bracket between the stock control arm brackets so that one side of the drop bracket is on the outside of the stock control arm bracket.

Important Note: *The exhaust on the passenger side of some models interferes with removal of the upper bolt. Cut the stock bolt and replace it with the Flange Hex Head Bolt and Hex Flange Nut provided.*

Note

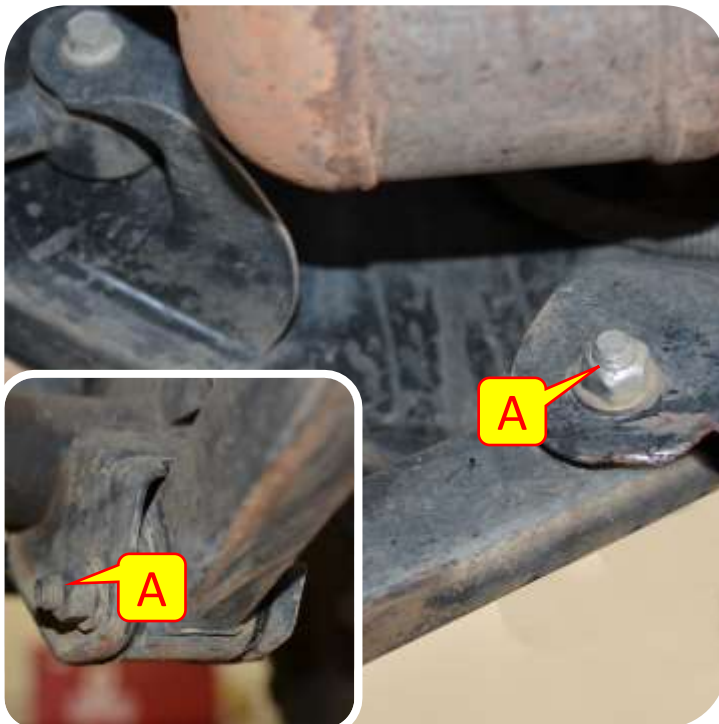

Section 3: Installation Instructions

Step 2: Front Drop Bracket

- C. Bolt the lower part of the drop bracket into place using the provided hardware. Use a 22mm socket and wrench. Make sure to insert the provided spacer into the drop bracket before installing the provided bolt into the stock control arm bracket holes.
- D. Bolt the upper part of the drop bracket into place using the provided hardware. Use a 19mm socket and wrench. Make sure to insert the provided spacer into the drop bracket before installing the provided bolt into the stock control arm bracket holes.

Important Note: Install the upper front control arm bolt from the outside of frame and the nut inside the frame. You will need a socket extension to access the head of the upper bolt inside the frame.



Section 3: Installation Instructions

Step 3: Front Control Arms

Important Note: the Upper front control arm hole location depends on the size of your lift. The upper hole is for 2.5" lifts the middle hole is for 3" lifts and the bottom hole is for 4" lifts.

Important Note: The lock nuts should be towards the front, at the frame mount for both upper and lower control arms.

CONTROL ARM SPECIFICATIONS...

	Caster Angle	Front Control Arms		Rear Control Arms	
		Lower	Upper	Lower	Upper
Factory Control Arms	Stock	22 5/8"	18 3/4"	19 3/4"	17 7/16"
MetalCloak 2.5" - 3.5" Lift	5 Degrees	23 1/16"	18 3/4"	20 7/16"	18 7/16"
MetalCloak 4.5" - 5.5" Lift	5 Degrees	23 9/16"	19 1/4"	20 15/16"	18 15/16"

- E. Using a 18mm socket and wrench install the Upper Front control arms using the stock hardware (*Use a 19mm socket and wrench for the provided hardware for the passenger side upper bolt*).
- F. Install the Lower Front Control Arms using a 21mm socket and wrench. Make sure the short bend (*with the Lock Nut*) is in the rear and the arm angles INBORAD to provide tire turning clearance.





Section 3: Installation Instructions



Coil Isolator Information Guide

Important Note: MetalCloak's suspension systems include a unique coil design that utilizes upper isolators to position the coil. The following table will help you identify where to install the isolators included with your kit. You must remove the stock isolators before installing the provided coil isolators. If you have any questions give us a call at 916-631-8071.

Coil Isolator Jeep Locations		
Tall Isolator	Jeep Model	Installation Locations
	JL Wrangler 3.6L Non-E Torque	Upper Front Passenger
	JL Wrangler 2.0T E-Torque	Upper Front Driver & Passenger
	JL Wrangler 4xE	Upper Front Driver & Passenger
	JL Wrangler Diesel	Upper Front Driver & Passenger
	JT Gladiator Diesel	Upper Front Driver & Passenger
	JK Wrangler (All Models)	Upper Front Driver & Passenger
	JL Wrangler 3.6L Non-E Torque	Upper Front Driver
	JL Wrangler 3.6L E-Torque	Upper Front Driver & Passenger
	JL Wrangler Turbo	Upper Front Driver & Passenger
	JL Gladiator 3.6L Motor	Upper Front Driver & Passenger
	JL Wrangler 3.6L Non-E Torque	Upper Rear Passenger
	JL Wrangler 4xE	Upper Front Driver & Passenger

Section 3: Installation Instructions

Step 4: Lowering Axle

- A. Droop your suspension to gain access to the spring perch. Be sure to watch the ABS lines so they do not get over extended and break.

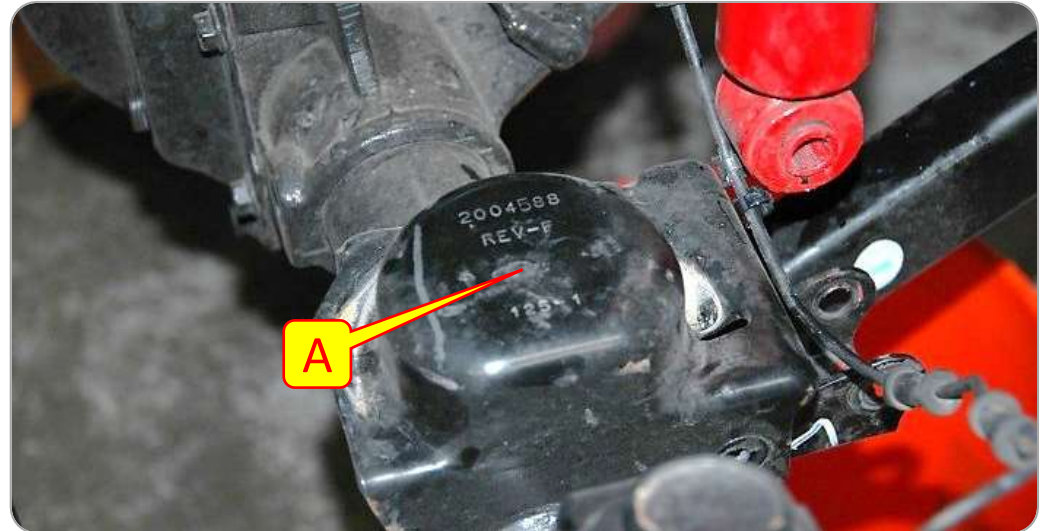

Step 5: Drill Spring Cup

- B. Center a Bump Stop Disk on the top of the spring perch and mark the center of the hole.
- C. Drill a hole at the marked location. You can start your hole with a smaller drill bit and work your way up to a 1/2".

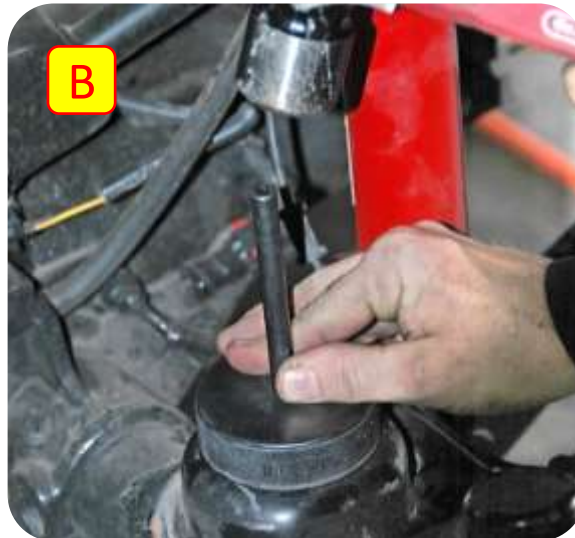

Section 3: Installation Instructions

Step 6: Install Bump Stop

- D. Select the appropriate Screw length so that the threads stick out of the bottom Disks approximately 3/4". Assemble your bump stops by feeding the 1/2" Countersunk Screw through the Cover Plate, and then threading through the Bump Stop Disks. The center hole in the Disk is intentionally small to create the most rigid assembly possible after installation.
- E. Place the assembled Bump Stop inside the spring before re-installing. Re-install the spring and place the end of the 1/2" Screw in the drilled hole.
- F. The 1/2" Screw is backed by a 1/2" Flanged Nylon Lock Nut. Install the nut and tighten the hardware using a 5/16" Hex Key Socket or Allen Wrench and a 3/4" Wrench. Tighten until everything is tight; the hardware will not bottom out, but instead will begin to compress the Disks.
- G. Repeat all steps for other side, and then re-install all other suspension components.

Note: *The bump stops may also be assembled in side the coil springs after they are installed.*

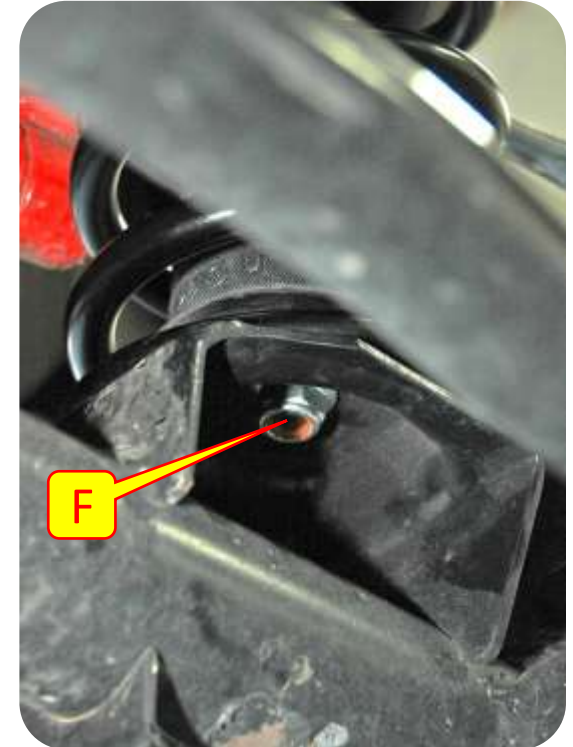

Section 3: Installation Instructions



Step 7: Install Front Coils

- H. If the axle does not “droop” enough to allow the coil to be put in place a coil compressor can be used to compress the coil to allow fitment.
- I. Install Front Dual Rate Coils with the tightly wound coils oriented upward.
- J. Slip the bottom of the coil onto the coil base on the axle.



Section 3: Front Shock Installation Instructions

Step 8: Install Upper Shock Mount Bracket

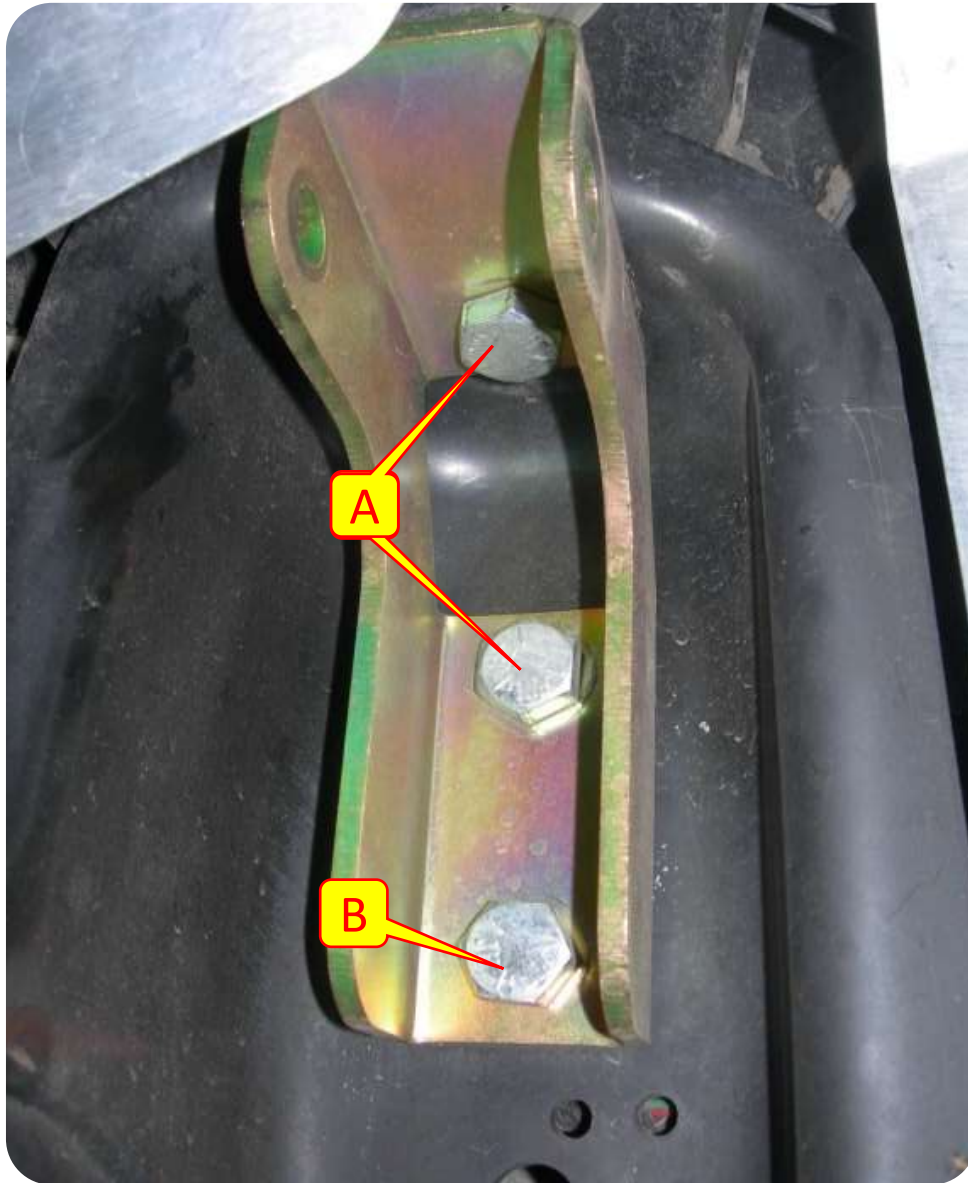

- Align the top 2 holes of the Upper Shock Mount Bracket to the stock holes of the shock mount tower. Install the provided 1/2"-13 Hex Cap Screws with a 1/2" Washer under the head, backed by 1/2" Flange Lock Nuts; finger-tighten the hardware.
- Center the Bracket in the shock mount tower. Mark the bottom hole, drill a 1/2" hole in this location, and install the third 1/2" Screw in this hole. Fully tighten all 1/2" hardware.
- Install the bushing end (top) of the 6Pak shock and the bottom of the shock in the stock mount.

Note: The 6-Pak Shock Reservoir Tubes (RED) should point away from the vehicle, perpendicular to the frame of the JEEP



Section 3: Installation Instructions

Step 9: Install Front Brake Line

- A. Use a 15mm Socket to remove the 'banjo' bolt from the brake calipers. Dis-guard the old copper washers. You will want an oil drain pan to catch the brake fluid.
- B. Use a 12mm Wrench to unscrew the stock brake line from the frame bracket.
- C. Unclip the ABS line from the brake line (all the way down), and use a 10mm Socket to remove the bolt holding the stock bracket. Remove the frame clip and brake line discard.

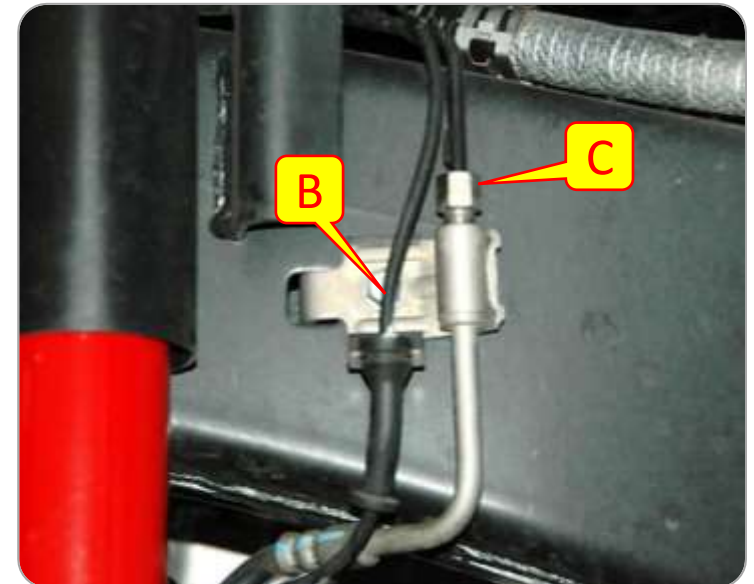
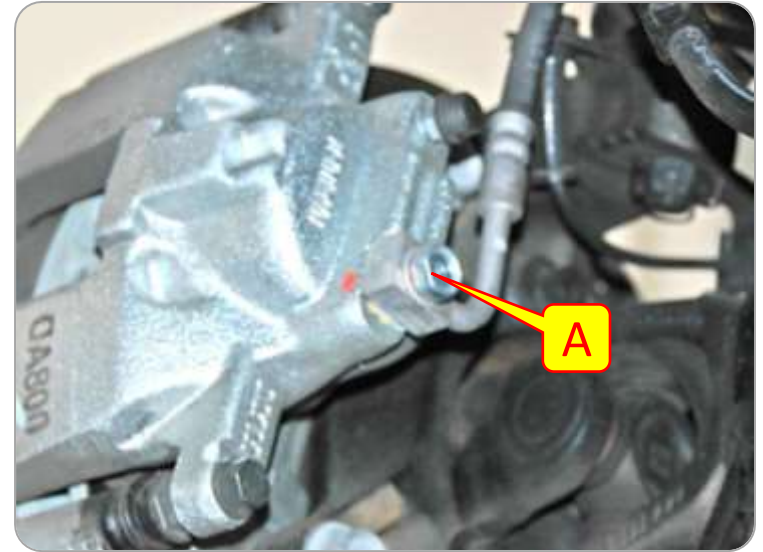

Section 3: Installation Instructions

Step 10: Install Front Brake Line

- D. Place the L-bracket on the frame in the factory location using the factory hardware.
- E. Install the 24-1/2" Brake Line through the bracket.
- F. Screw the stock line into the new Brake Line, and tighten using a 12mm and 17mm Wrench.
- G. Install the provided Spring Clip to retain the Brake Line in the Bracket. You may need a hammer to lightly tap this clip into place.
- H. Use a 1/2" Socket to install the 5/16"-18 Hex Head Self-Tapping Screw. Do not fully tighten.
- I. Feed the banjo bolt through the square end of the brake line. Use the provided brass washers on both sides of the brake line as shown.
- J. Re-install the banjo bolt into the brake caliper.
- K. Zip-tie the ABS lines to the new brake lines.

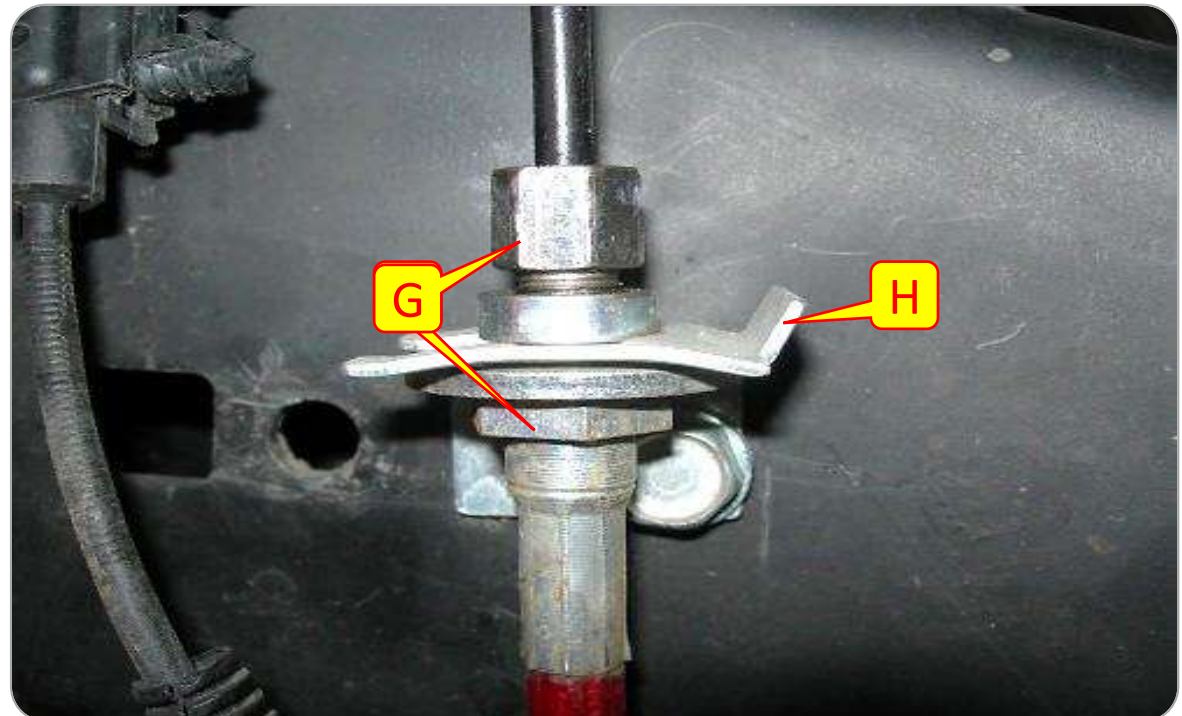

Section 3: Installation Instructions

Step 11: Drag Link Flip Kit

- A. Remove factory drag link from the steering pitman arm and the axle.
- B. Disconnect the axle mount side of the steering stabilizer (*If you have an aftermarket steering stabilizer mount, disconnect the mount*).
- C. Place the Flip Kit Mount over the top of the Axle
- D. Hand Tighten U-Bolt.

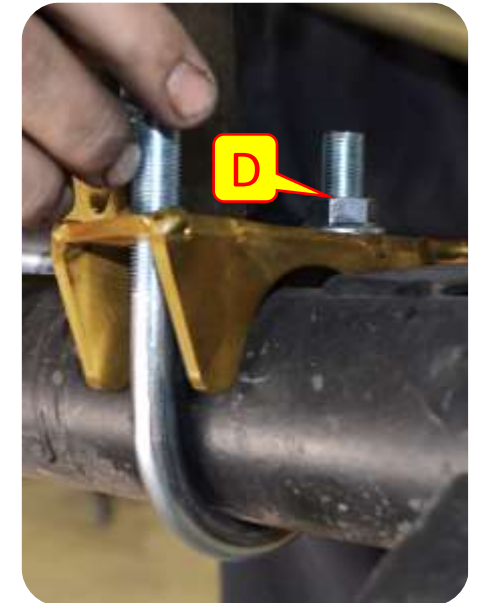

Section 3: Installation Instructions

Step 11: Drag Link Flip Kit

- E. Insert the bottom bolt spacer. It will go into the factory track bar location
- F. Using a 10mm Allen Socket and a 22mm wrench install the bottom bolt.
- G. Adjust Track Bar. As a starting point you can start out at 32 3/4". The adjustment end will go into the axle bracket, this end will also go in once the vehicle is on the ground.
- H. Install track bar using a 14mm socket and a 22mm wrench.
- I. Tighten the U-bolt nuts using a 19mm socket.

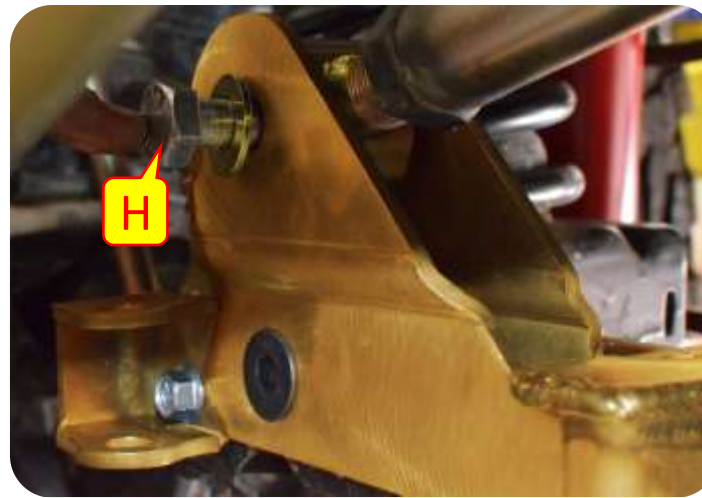
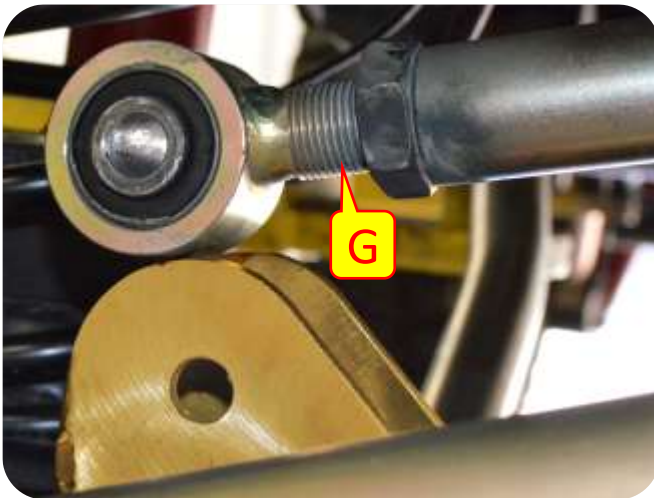
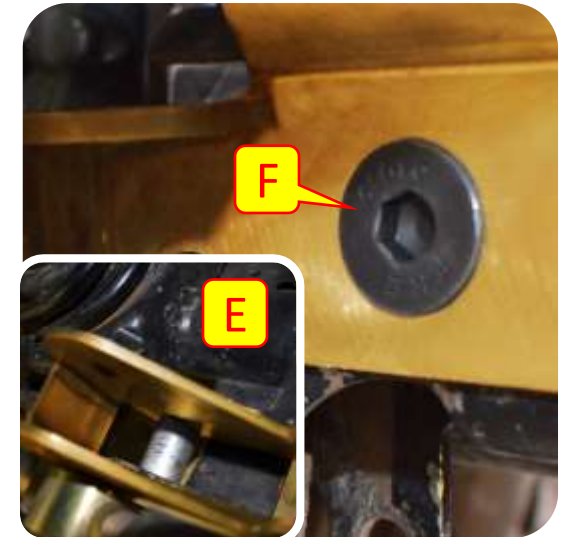

Note: It is helpful to have someone push the vehicle to the driver or passenger side to help align the hole; if you don't have an extra pair of hands you can use a ratchet strap on the frame/axle to pull the frame in the desired direction. Check to ensure the axle is centered once the bolt is in place. If not then remove the bolt, adjust the Track Bar length, replace the bolt, and re-check axle centeredness. Repeat until the axle is as close to center.

Section 3: Installation Instructions

Step 11: Drag Link Flip Kit

- J. Install the steering stabilizer mount bolt and nut using a 9/16" wrench and socket (*insert the nut between the original steering stabilizer mount location*).
- K. Using a 7/8" drill bit drill out the drag link knuckle.

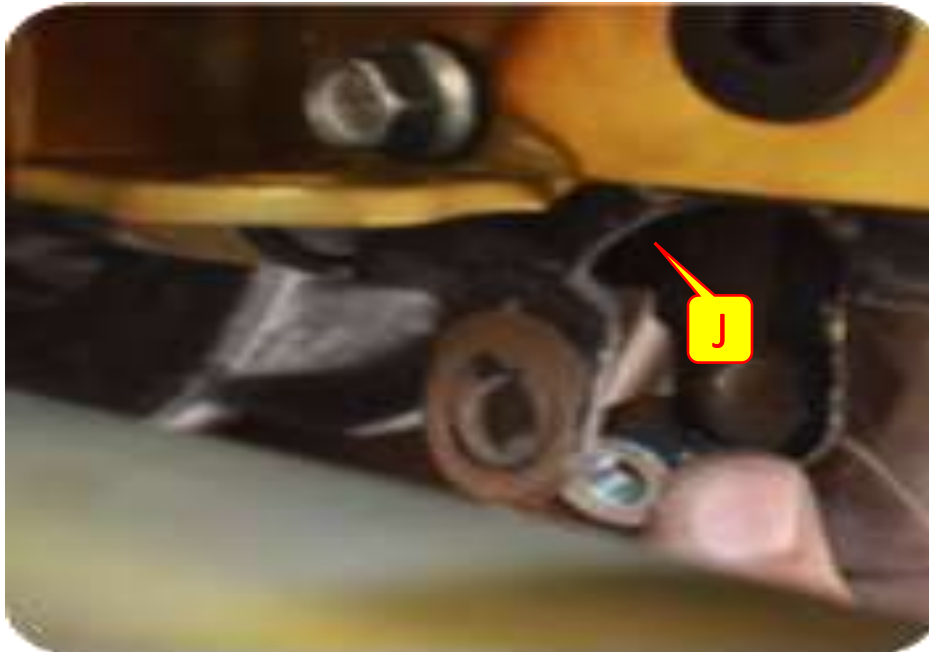
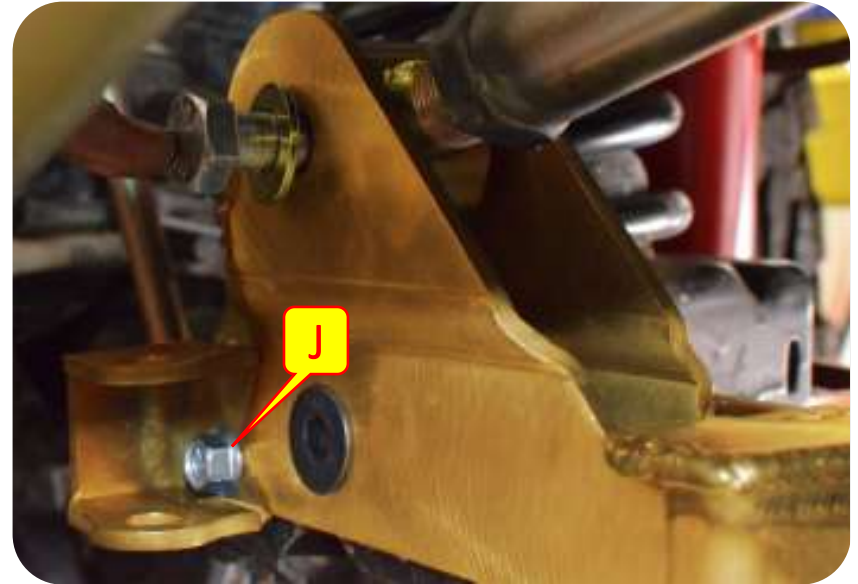

Section 3: Installation Instructions

Step 11: Drag Link Flip Kit



- L. Insert spacer into drilled out hole.
- M. Install new drag link into the knuckle and the steering box pitman arm.
- N. Tighten down drag link nut using an adjustable wrench
- O. Install cotter pin
- P. Install the steering stabilizer into the steering stabilizer mount (*Install the bolt with the nut on top and tighten with a 19mm socket and wrench*).

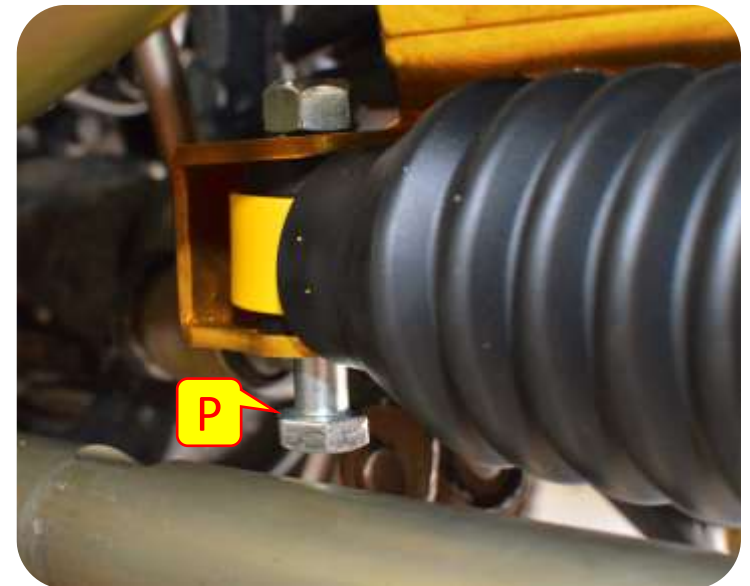
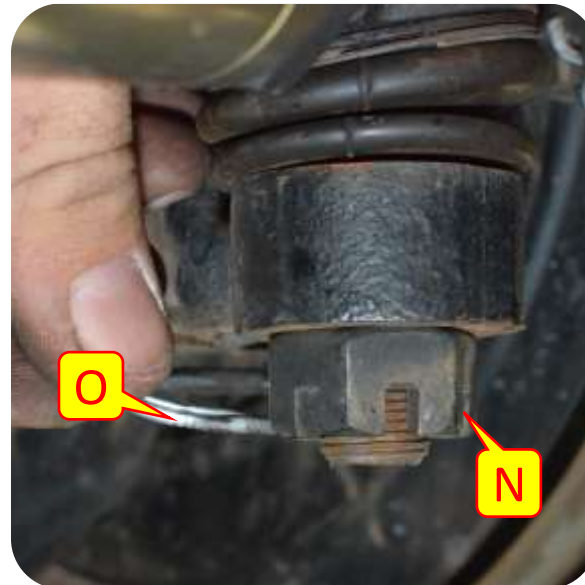

Section 3: Installation Instructions

Step 12: Front Track Bar

- A. The fixed end of the MetalCloak JK Front Track Bar goes in the stock frame bracket. The clearance bends should point toward the front bumper, up and away from the differential cover. Re-use the stock hardware, and only hand tighten the hardware for now (you will fully tighten everything at the end).
- B. The adjustable end of the Track Bar goes into the stock bracket on the axle, again re-using the stock hardware. With the full weight of the vehicle on the springs, push the bolt through the bracket and the Track Bar joint.
- C. Fully tighten the stock hardware on both ends of the Track Bar, and then tighten the Jam Nut on the Track Bar.
- D. MetalCloak **STRONGLY RECOMMENDS** having your alignment checked by a professional after changing any suspension components.

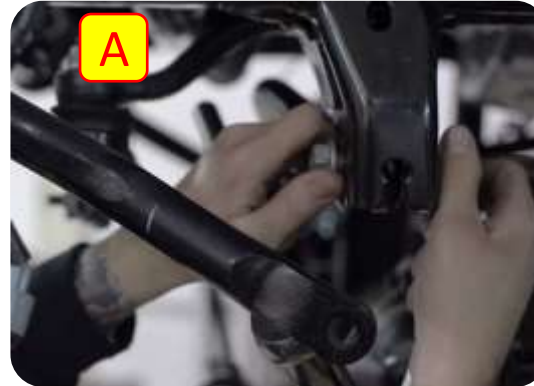

Note: It is helpful to have someone push the vehicle to the driver or passenger side to help align the hole; if you don't have an extra pair of hands you can use a ratchet strap on the frame/axle to pull the frame in the desired direction. Check to ensure the axle is centered once the bolt is in place. If not then remove the bolt, adjust the Track Bar length, replace the bolt, and re-check axle centeredness. Repeat until the axle is as close to center.

Section 3: Installation Instructions

Step 13: Sway Bar Links

- A. Install the lower quick disconnect pin in the stock location. Point the pin toward the center of the vehicle, backed by the provided ½"-13 hardware. A screwdriver through the hole on the end of the pin is helpful while tightening the nut with a 3/4" wrench.
- B. Assemble the sway bar link by threading a jam nut onto the lower link.
- C. Now thread the link into the ball joint. Set the length to 12.25". Do not tighten Jam nut yet.
- D. Install the ball joint on the outside of the sway bar end. You will need a thin 9/16" box end wrench to keep the ball joint from turning while you tighten the nut with a 5/8" wrench.

Important Note:
MetalCloak recommends using red Loctite on each of the upper spindles of the sway bar end links.

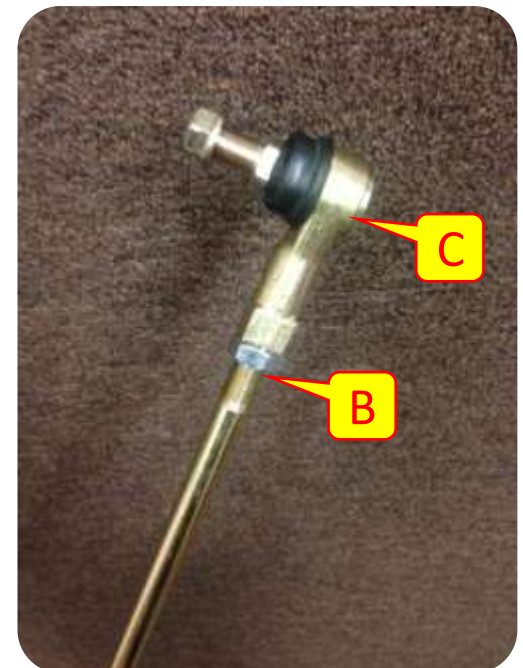
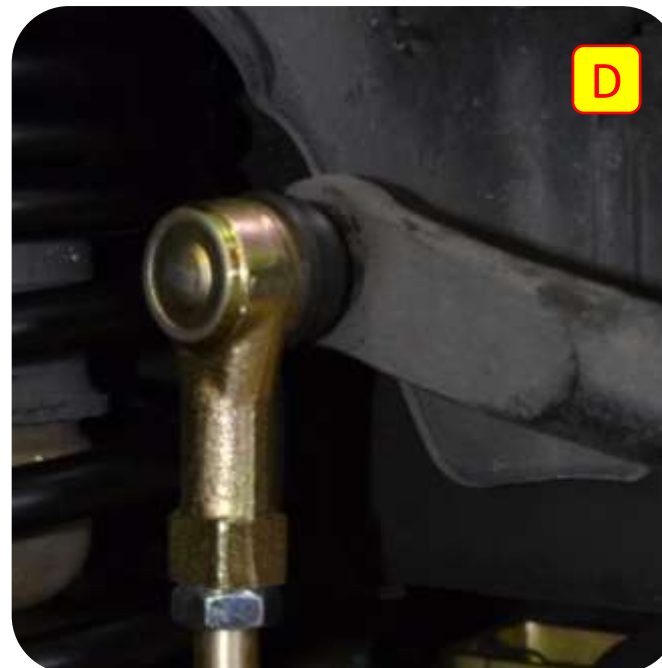
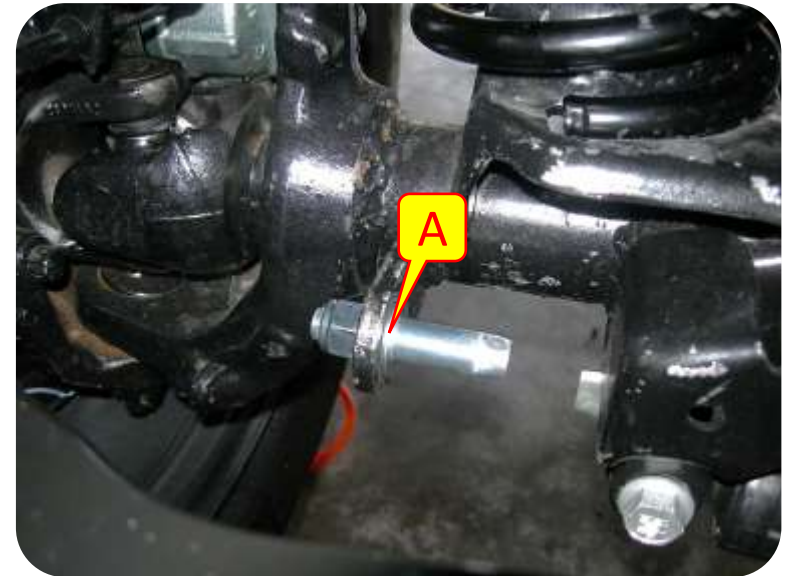

Section 3: Installation Instructions

Step 13: Sway Bar Links

- E. Installed lower rubber bushing on the quick disconnect pin.
- F. Tighten the jam nut.
- G. Disconnect the links and align the provided brackets in the desired location. There is no exact location; the goal is simply to keep the sway bar clear of the tires when stowed. Mark the locations and drill with a 9/32" drill bit. Install the self-tapping screws through the bracket using a 1/2" wrench.
- H. Re-attach the links to the lower pins and install the 1/4" Locking Pins. These may be snug against the rubber bushing, so don't be surprised if you need to use a little muscle to push them through.

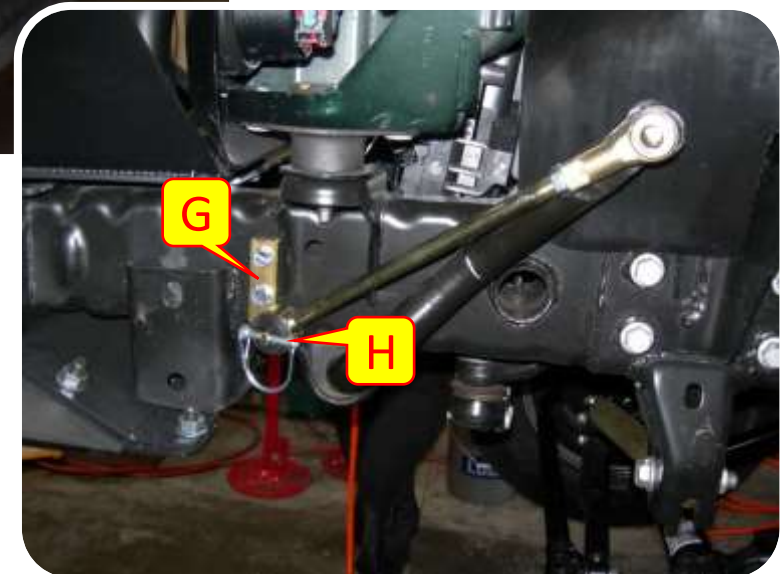
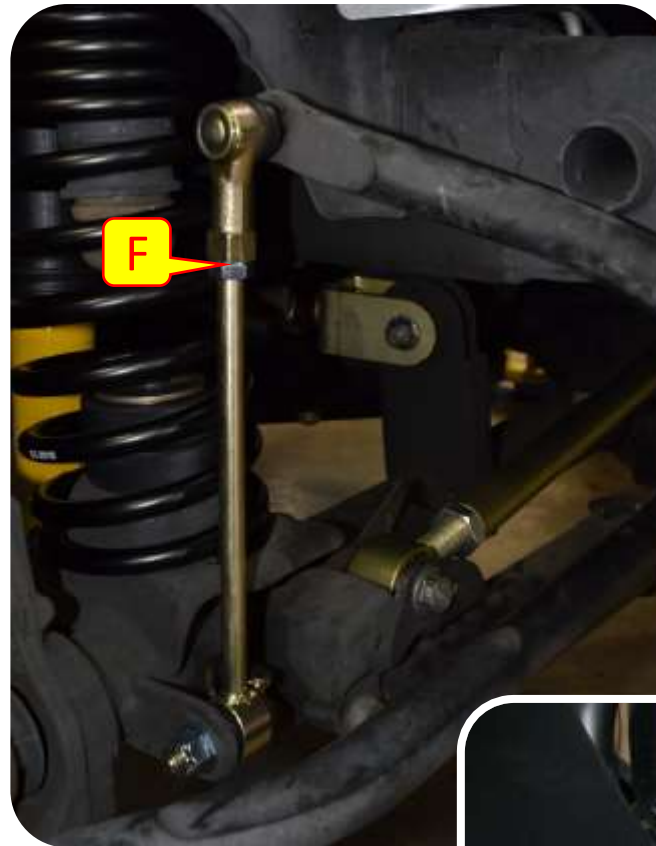

Section 3: Installation Instructions



Step 14: Finalize Installation

- A. Adjust the caster angle and toe as needed. Once set, tighten all hardware. Finally, tighten the jam nuts on all control arms.

Section 3: Installation Instructions

Note: When lifting any vehicle, basic dynamics are changed. It is important for you to take your vehicle to a professional for alignment after installation. When doing so, make sure he is setting caster for lifted vehicle (not stock specs).

Step 1: Remove Stock Components

- A. Disconnect rear sway bar links. Save the lower bolt for later use.
- B. Disconnect rear brake lines. Go ahead and replace the brake lines at this time.
- C. Remove the rear track bar. Save the upper bolt for later use.
- D. Remove the shocks.
- E. Remove stock springs, and any spacers that have been used if vehicle has been previously lifted. The rubber isolator will be re-used.
- F. Disconnect rear control arms. Keep Hardware.

Important Note: Make sure you support the rear axle with jack stands.



Section 3: Installation Instructions

Step 2: Install Rear Brake Lines

- A. The steps to replace the rear brake lines are essentially identical to the front. Use the M6 screw to install the L-Bracket in the stock location, and then install the Brake Line following the same steps as the front.

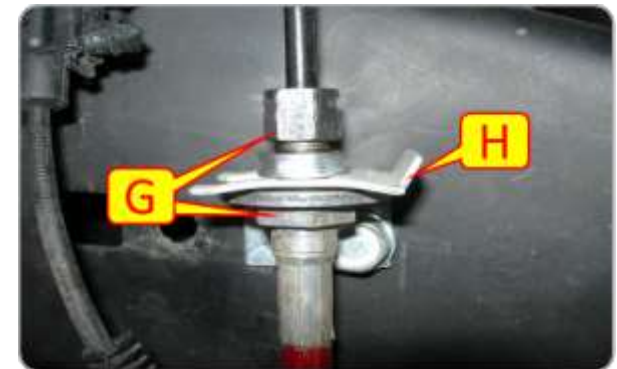
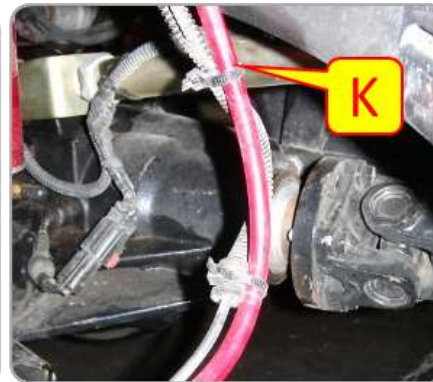

Step 3: Bleed Brakes

CAUTION!! FAILURE TO PROPERLY BLEED THE BRAKE LINES WILL CAUSE YOUR BRAKES TO BE INEFFECTIVE. Before your vehicle is ready to drive you will need to refill the brake reservoir and bleed the air out of the brake lines. If you are not experienced with this process, or have any reservations, consult a professional. For a full write-up of the brake bleeding process for your JEEP Wrangler JK, you can also refer to <http://project-jk.com/jeep-jk-write-ups/jeep-jk-wrangler-maintenance-bleeding-your-brakes>.

Section 3: Installation Instructions

Step 3: Rear Track Bar Bracket

- A. Slide the MetalCloak Track Bar Bracket in place as shown and re-install the stock bolt through the control arm; do not fully tighten any hardware until the Bracket is fully installed.
- B. Insert the provided Spacer in the axle bracket where the stock track bar was mounted.
- C. Install the provided M14-2x100mm Hex Cap Screw through the stock hole with a Washer under the head of the Screw.
- D. The Screw is backed by a M14 Nylon Jam LockNut and Washer; install but do not fully tighten.
- E. Use a 3/4" Socket to install the 1/2"-20 U-bolt with the provided 1/2"-20 Flange LockNuts. You can snug all the Bracket hardware at this time, but do not fully tighten.

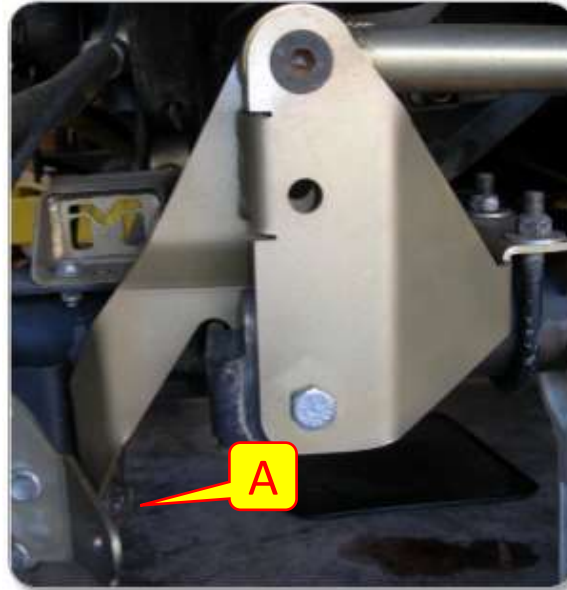

Section 3: Installation Instructions

Step 4: Install DB3

- A. Install axle side of rear control arms.
- B. Place bracket up to the frame over the stock control arm bracket and mark hole to get ready for drilling.



Section 3: Installation Instructions

Step 4: Install DB3

- C. Install the spacer and stock hardware in the Stock Upper Rear Control arm bolt hole hand tight.
- D. Install the spacer and stock hardware in the Stock Lower Rear Control arm bolt hole hand tight.
- E. Install the lower skid bolt and washer using the provided hardware.

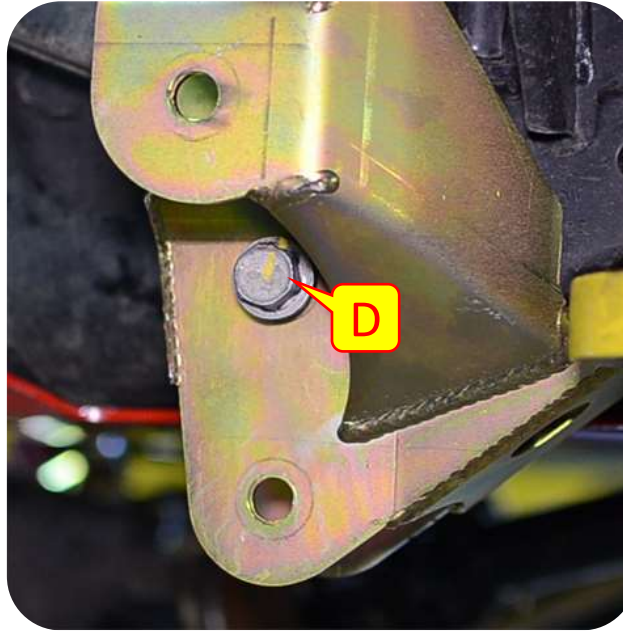

Section 3: Installation Instructions



Step 4: Install DB3

- F. Using a 9/16" drill bit, drill out the marked hole for clearance for the bolt and flag nut.
- G. Install the rear lower control arm with provided hardware.
- H. Install the Upper Control Arm with provided bolt and flag nut. The MetalCloak rear upper arm should be oriented so that the bend in the arm angles inboard to provide tire clearance.
- I. Tighten all hardware.
 - Stock Hardware – 21mm wrench & socket
 - Hex Hardware – 3/4 (19mm) wrench & socket
 - Skid Hardware - 7/8 (23mm) wrench & socket

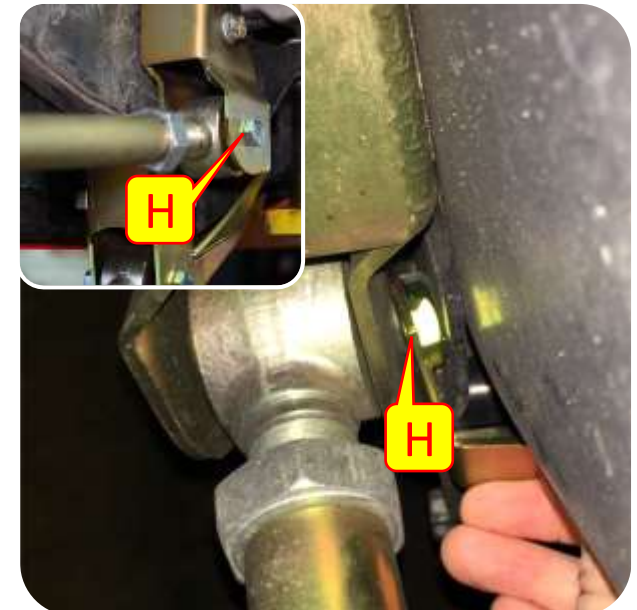
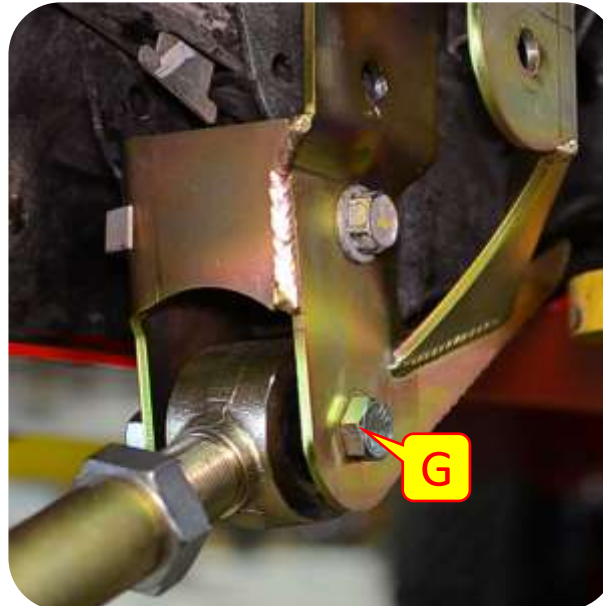
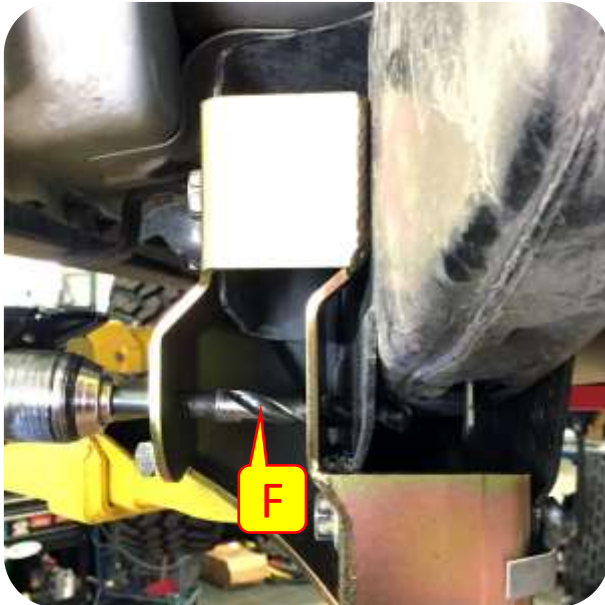

Section 3: Installation Instructions



Step 5: Install MetalCloak Track Bar

- A. Pre-set the length of the MetalCloak Track Bar to 40-1/8" eye-to-eye. This length can be adjusted for your specific build.
- B. Install the MetalCloak Track Bar using the stock hardware. On the bottom the BOLT HEAD should face REARWARD, and on the upper mount the NUT should be to the rear. Tighten all hardware.

A

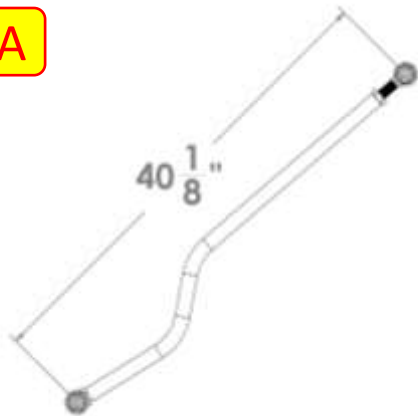

B

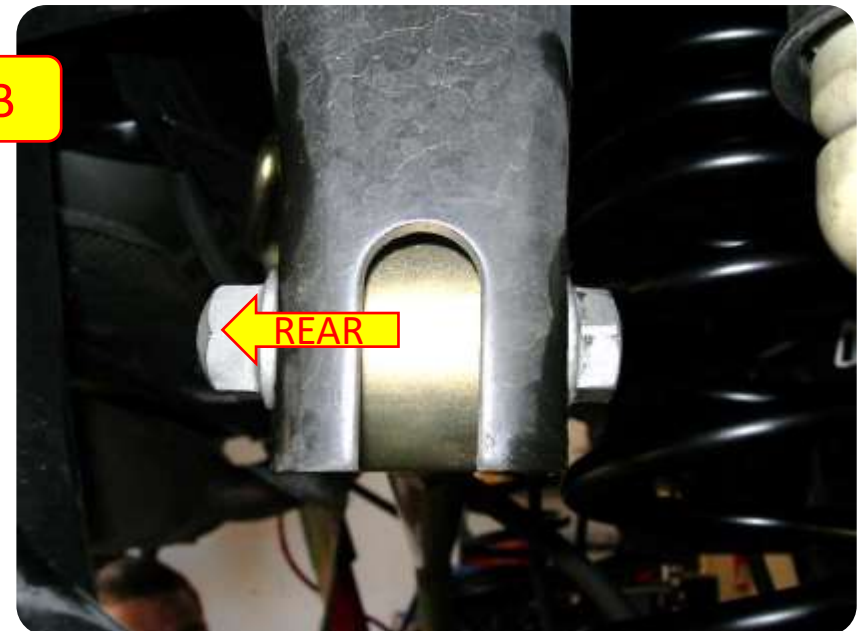
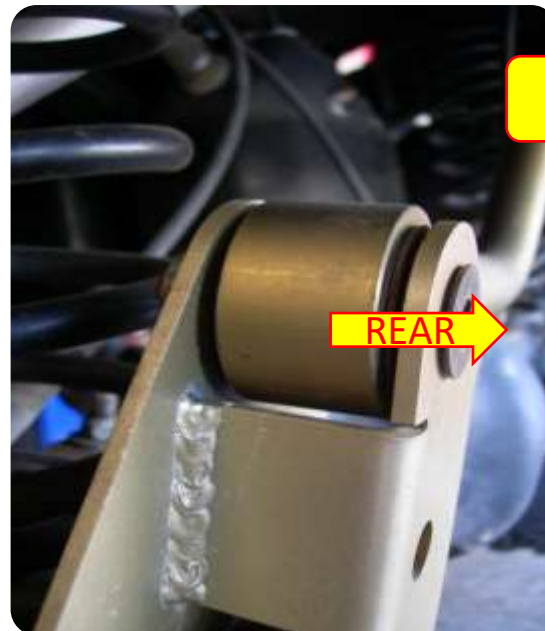

Section 3: Installation Instructions

Step 6: Install Rear Coils and Retainers

- A. Place the coil spring correction plate onto the rear coil bucket.
- B. If the axle does not “droop” enough to allow the coil to be put in place a coil compressor can be used to compress the coil to allow fitment.
- C. Place the Rear Coil Cup on top of the Rear Dual Rate Coil.
- D. Install Rear Dual Rate Coils with the tightly wound coils oriented upward.
- E. Slip the bottom of the coil onto the coil base on the axle.

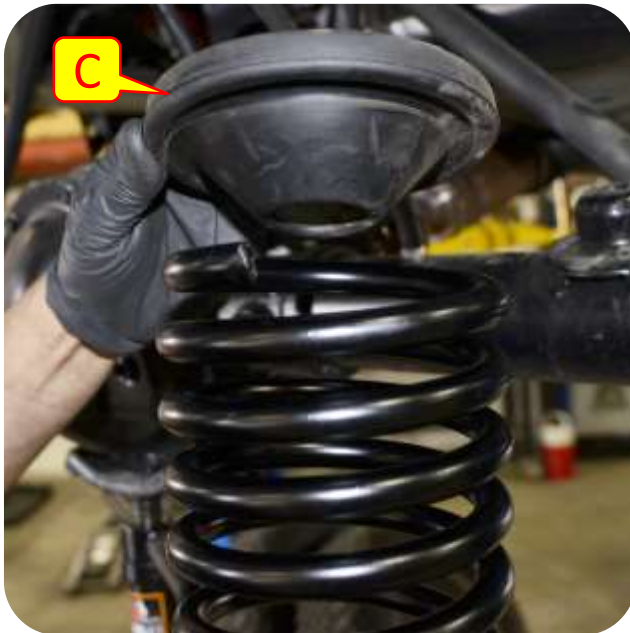
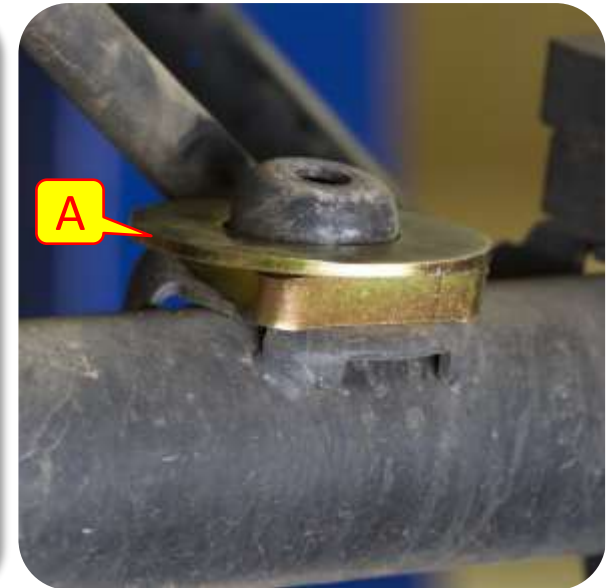

Section 3: Installation Instructions

Step 6: Install Rear Coils and Retainers

- F. Install Retainer Washer onto the top of the coil bucket.
- G. Place the Coil Retainer Plate onto the top of the coil spring tail.
- H. Insert the provided bolt and washer into the coil retainer plate and coil bucket.
- I. Insert the flange nut into the coil bucket and start to thread the flange nut onto the spring retainer bolt.
- J. Using a 19mm wrench tighten down the spring retainer bolt.
- K. Repeat Steps for other side and reinstall disconnected components.

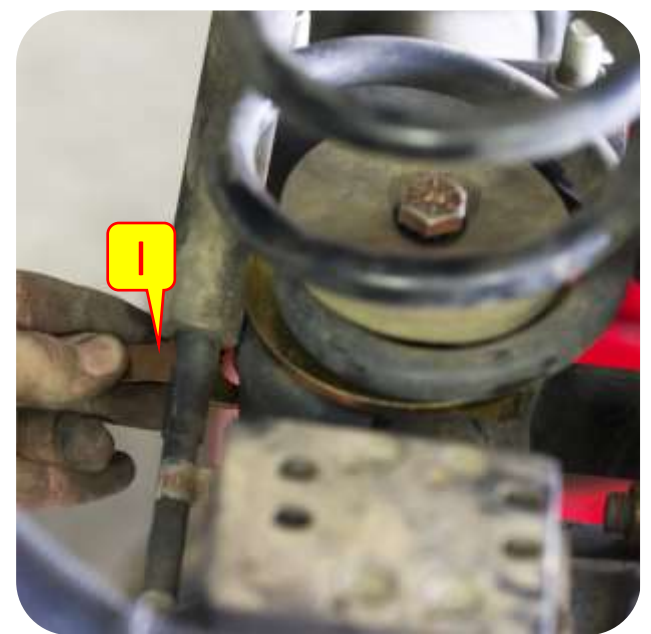
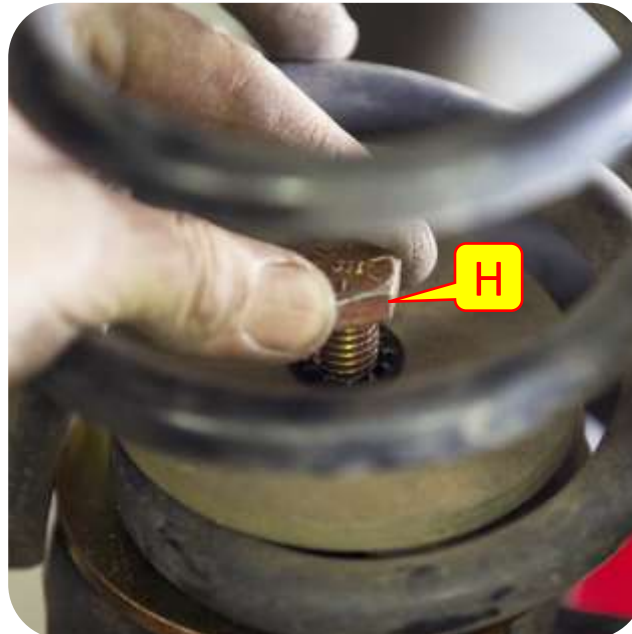

Section 3: Installation Instructions

Step 7: Install Rear Shocks

Note: The following steps are optional; if you do not intend to trim the Lower Stock Shock Mount Bracket skip to Step 2.

- A. Mark the side of the Lower Stock Shock Mount Bracket **3-7/8"** from the bottom of the axle.
- B. Mark the rear of the Lower Stock Shock Mount Bracket **4-3/4"** from the top of the bracket.
- C. Use a Cut-off Disc and Grinder to trim the Stock Shock Mount Bracket, including any protruding portion above the marked locations. Blend the transition as shown and paint exposed metal.

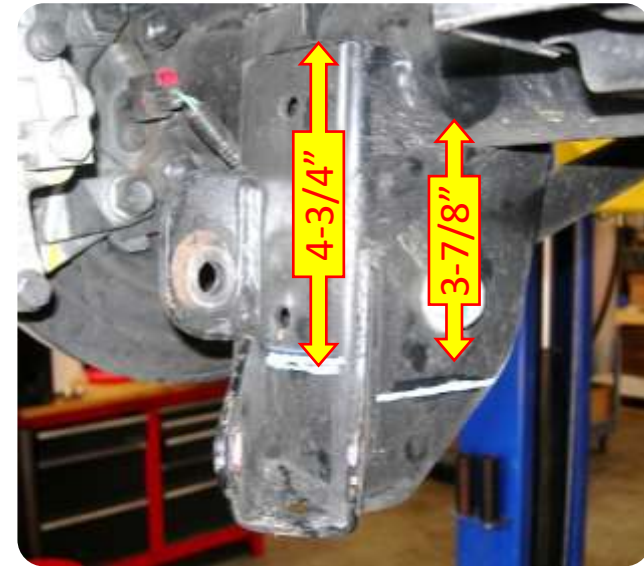

C



Section 3: Installation Instructions



Step 8: Install Rear Shocks

- D. Locate the MetalCloak Lower Shock Mount Bracket (Bracket is symmetrical and can be reversed for Driver and Passenger Side) using the stock holes. The lower hole of the “figure 8” opening of the Shock Mount Bracket aligns with the stock sway bar link hole as shown.
- E. Mark the upper hole on the Shock Mount Bracket to be drilled.
- F. Remove Shock Mount Bracket and drill marked hole with a 7/16” Drill. The frame is made from a very hard steel, and we recommend drilling a 1/4” (or similar) pilot hole.
- G. Install the 3/8”-16 Flange Hex Head Screws and Nuts using a 9/16” Socket and Wrench.
- H. Reinstall the stock sway bar link bolt. Fully tighten all hardware.

Important Note: Depending on your suspension setup, you may need to leave the sway bar links disconnected until after the shock installation.

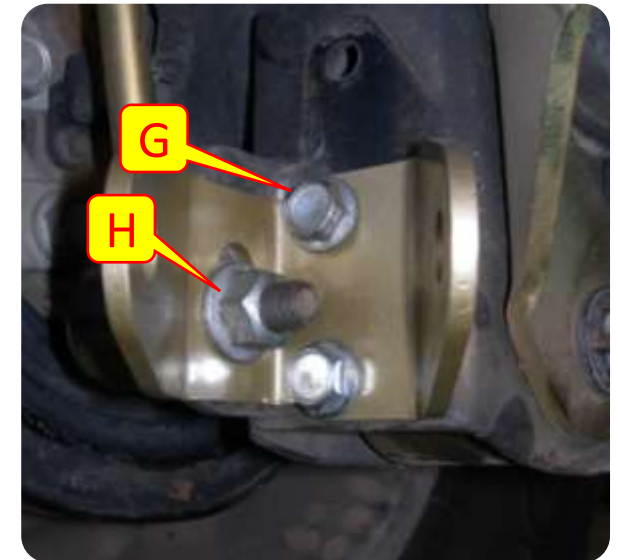
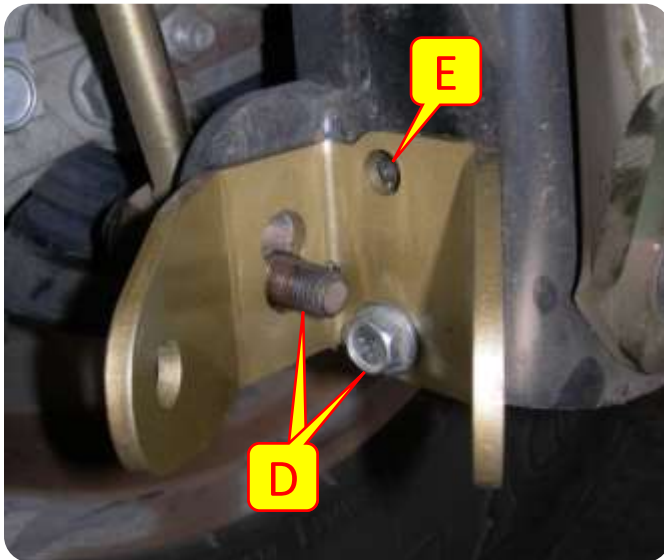

Section 3: Installation Instructions

Step 9: Install Rear Shocks

- I. Install the Bar Pin Eliminator in the 6-Pak Shock Rod-End. Feed the male piece through the Rod-End and into the female piece.
- J. Use a 17mm Socket, and the provided replacement M10 Screws and Washers, to install the Bar Pin Eliminator in the upper stock location, oriented so that the 6-Pak Rod End is offset INBOARD.

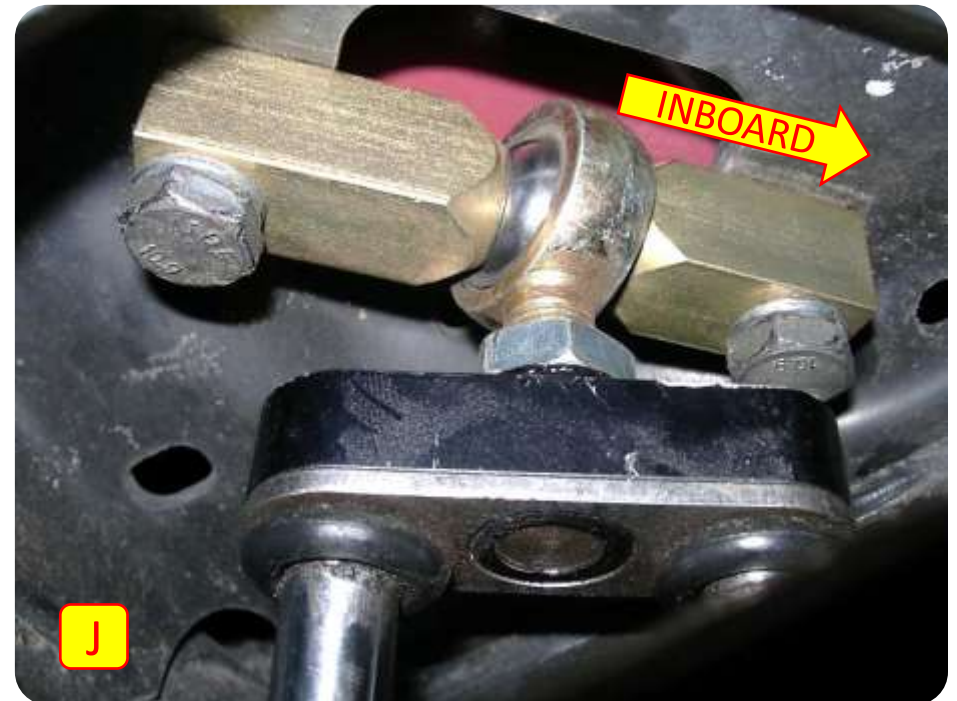

Section 4: Rear Shock Installation Instructions

Step 9: Install Shock

- K. Use the provided 1/2"-13 x 2.5" Hex Head Screw, Washer, Hex Flange Nut and Spacers to install the lower Rod End (*bushing side*) in the Shock Mount Bracket. The Washer goes under the head of the Screw, and the Flange Nut goes directly against the bracket.
- L. The 6-Pak Shock Reservoir Tubes (RED) should be oriented INBOARD. The body of the 6-Pak Shock should be oriented such that the clearance between the Stock Sway Bar and the 6-Pak Shock Body is the same as the clearance between the Track Bar Bracket and the 6-Pak Shock Body. In other words, center the Reservoir Tubes the Track Bar Bracket and Stock Sway Bar.

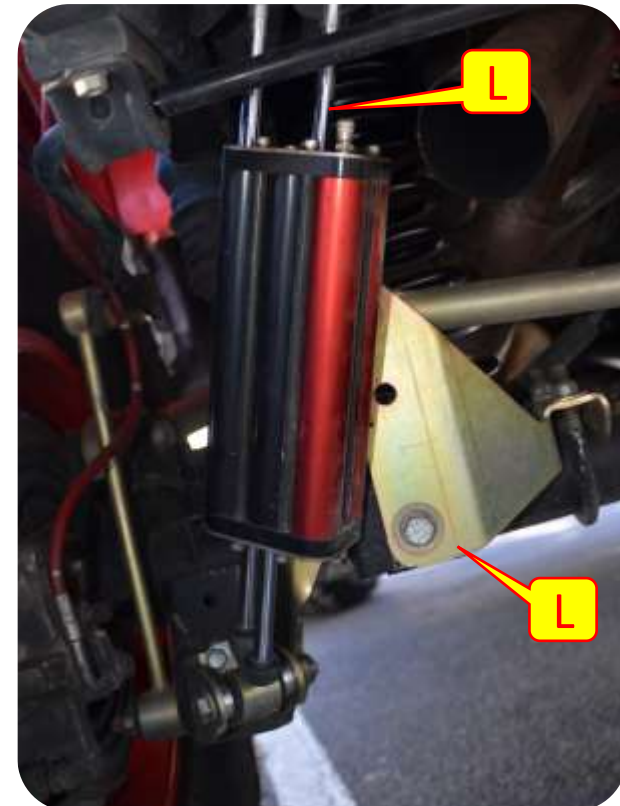

Section 3: Installation Instructions



Step 10: Install Rear Sway Bar

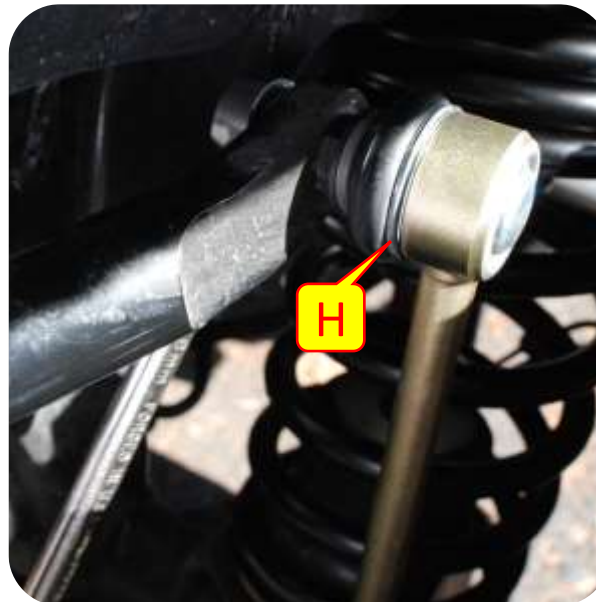
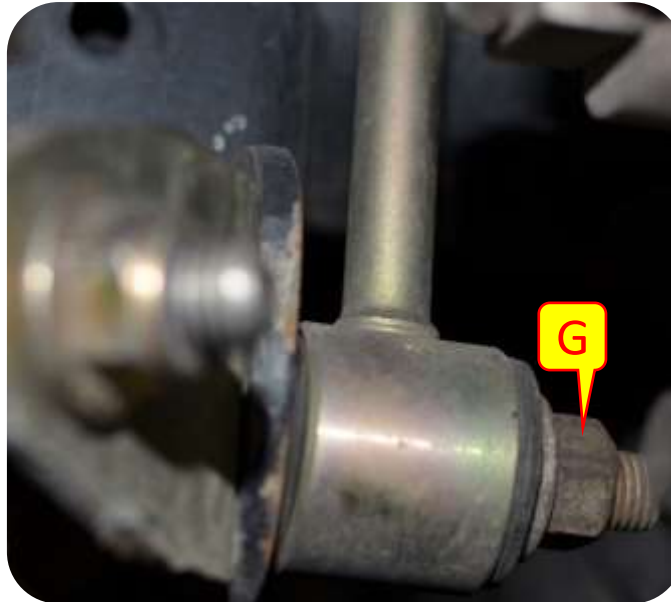

- G. Using the factory hardware install the bottom of the MetalCloak extended sway bar links.
- H. Using the factory hardware install the top of the MetalCloak extended sway bar links.
- I. Torque upper and lower bolts to 75lbs.

Section 3: Installation Instructions

Step 11: Install Rear Bump Stops

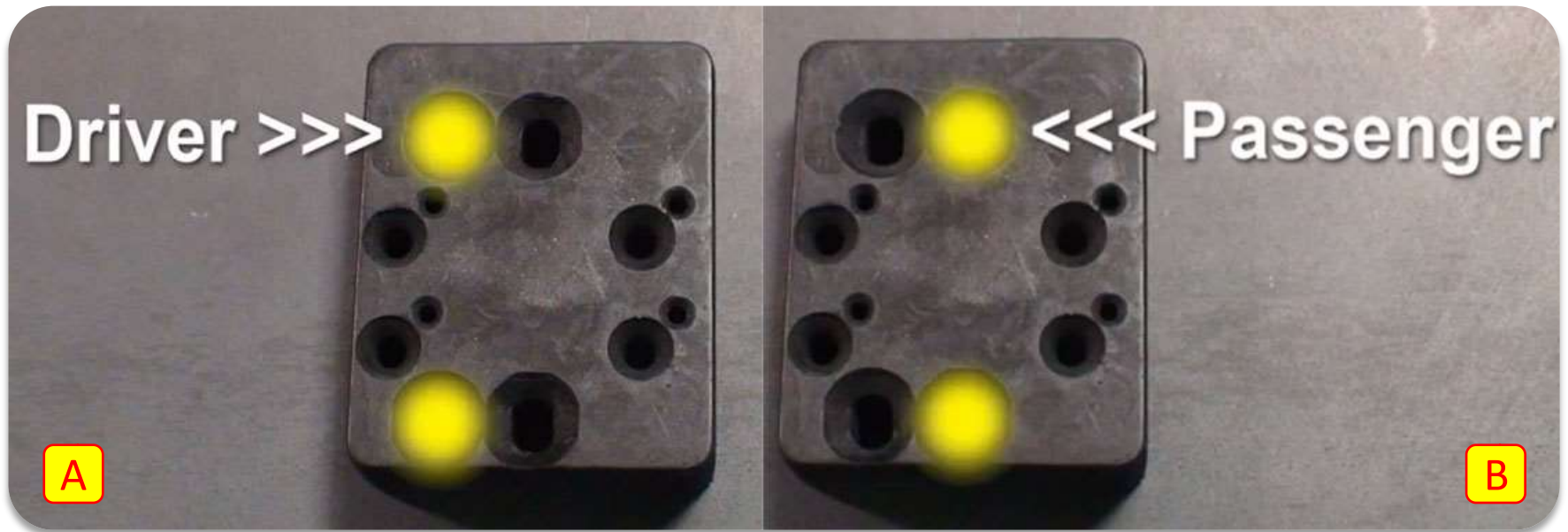

- A. Driver Side Bump Stop Holes.
- B. Passenger Side Bump Stop Holes.
- C. Diagram showing the two sides of the Bump Stops.

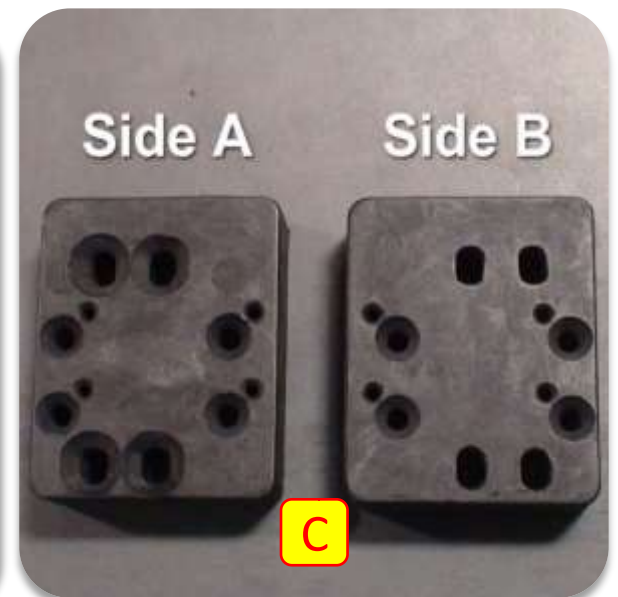

Section 3: Installation Instructions

Step 11: Install Rear Bump Stops

D. Install first bump stop puck (Side A) using the correct holes (shown in step A and B) using the 5/16 bolt with the matching nut and washer.

E. Install next puck (Side B) using the 1 3/4" woodscrews.

F. Continue until desired bump stop height (Side A/Side B/ Side A/Side B).



Step 12: Bleed Brake Lines

Important Note: *Before driving bleed brake lines.*

