



PRODUCT: JK Four Link Long Arm System, RockSport

REV: B | 03-25-2024 | II-A1645/A1655

READ INSTRUCTIONS IN FULL BEFORE INSTALLATION.

QUESTIONS? CALL 916-631-8071 M-F 7:00 AM – 5:00 PM PST

The MetalCloak experience includes the ease of installation of our products. We design for most contingencies, but installation may be different based on different Jeep condition, configuration and/or year.

We are continually trying to improve our products and instructions – please help us by providing feedback and pictures if you find any part of the instructions that do not match your particular Jeep or are not easily understandable.

If you have any difficulties at all, please give us a call. Thank you and enjoy your MetalCloak Products!

IMPORTANT NOTE: We use Stainless Steel Hardware where possible. Therefore, a tube of Silver Anti-seize is provided and should be used on all bolts—only a small amount is needed.

WARRANTY INFORMATION: This article is sold without warranty expressed or implied. No warranty or representation is made as to this products ability to protect the user from injury or death. The user assumes that risk. The effectiveness, warranty and longevity of this equipment are directly related to the manner in which it is INSTALLED, USED and/or MAINTAINED. THE USER ASSUMES ALL RISK. By purchasing this product and opening the packaging, purchasers expressly acknowledge, understand and agree that they take, select and purchase these MetalCloak products from Armored Works, LLC, its affiliates and distributors and agents as is and with all faults. The entire risk as to the quality and performance of these MetalCloak products is with the purchaser. Working on your vehicle can be a dangerous activity. If you are unsure of what you are doing, please leave mechanical or safety critical work to a skilled mechanic. We take no responsibility for the incorrect use and/or installation of MetalCloak products.

Section 1: Tools & Notes on Installation

Tools Required: This list is the recommended tools for ease of installation. Other versions of the same tool can be used. For example, Allen Wrenches instead of Allen Drive Sockets.



Socket & Ratchet Wrench

Metric Hex Drive Sockets
and/or Hex (Allen) Wrenches



Metal Head Hammer

Cut-Off Disc and Grinder
(Optional)



10" Socket Extension

3/8" Flare Nut Wrench (10mm will
work) for Brake Lines



Grinder / Cutoff wheel

Electric Drill/Drill Bits
1/4", 1/2", 7/16"



Welder (Optional)

HOW TO USE THIS GUIDE: The installation guide contains ALL steps for installation. Please read and follow the instructions in order of each page top to bottom, and left to right.

Jeep Model: Instructions may apply to multiple Jeep models, but are labeled separately where appropriate (i.e. TJ vs. LJ).

Options: Because of the number of component options we offer, these instructions may contain steps that will not match your particular configuration. You can skip these steps.

Images: Pictures are provided and parts are labeled throughout the instructions. Each text box contains guidance based on the pictures next to it. The text will refer to alphabetical labels (A, B, etc.) found in the images.

Installation Notes: Terms may be used in the body of the instructions that you may not be familiar with, if you have any questions feel free to contact us at the number below, or email techhelp@metalcloak.com

QUESTIONS: Any questions or comments about the instructions? Call us at 916-631-8071 M-F 7:00 AM – 5:00 PM PST.

Section 3: Installation Instructions



This is an advanced suspension install for experienced technicians; If you are not competent with advanced automotive mechanics, cutting, drilling, and welding it is recommended to have this system installed by a MetalCloak Authorized Installer.

Safety Warning: *Suspension systems or components that enhance the off-road performance of a vehicle may cause it to handle differently on or off-road than it did from the factory. Care must be taken to maintain control of modified vehicles during sudden maneuvers. Failure to drive the vehicle safely may result in serious injury or death to driver and passengers. MetalCloak recommends always wearing a safety belt, driving safely trying to avoid sudden maneuvers. As with any vehicle maintenance is required to keep it operating safely. Thoroughly inspect your vehicle before and after every off-road use.*

Installation Warning: *MetalCloak recommends that certified technicians perform the installations of MetalCloak products. These instructions only cover the installation of our products and may not include factory procedures for disassembly and reassembly of factory components.*

Read instructions from start to finish and be sure all parts are present before disassembling the vehicle. These instructions are only guidelines for installation and in no way meant as definitive. The installer is responsible to insure that the vehicle is safe for use after performing modifications.

Exhaust modifications and CV driveshafts are required for this Long Arm System. Be sure to source these items in order to complete the installation.

Important Note: *MetalCloak does not recommend powder coating your True Dual Rate Coils. The baking process in powder coating can, in some cases, cause the metallurgical properties of the coils to be changed, resulting in the loss of the lift properties of the coils. As such, the process of powder coating the coils will void any warranty stated or implied in relation to the coils.*

Important Note: *To install lift components you will need to fully 'droop' your suspension in the front and rear (not at the same time). We strongly recommend that the vehicle be placed on an automotive lift and that all appropriate safety precautions be taken to secure the vehicle while it is off the ground. Always use the necessary axle stands (or equivalent) to support the axle when the suspension components are disconnected for safety, and to ensure the integrity of your suspension system during the installation process.*

Section 3: Installation Instructions

Important Note: To prevent tires from rubbing the shocks at full turn and flex, a clearance of 11-3/4" between inner wall of the tire and the outside of the frame rail is recommended. Wheel backspacing, wheel spacers, axle width and tire width can effect this value. We recommend a wheel backspacing of less than or equal to 4.0" for most common vehicle builds.

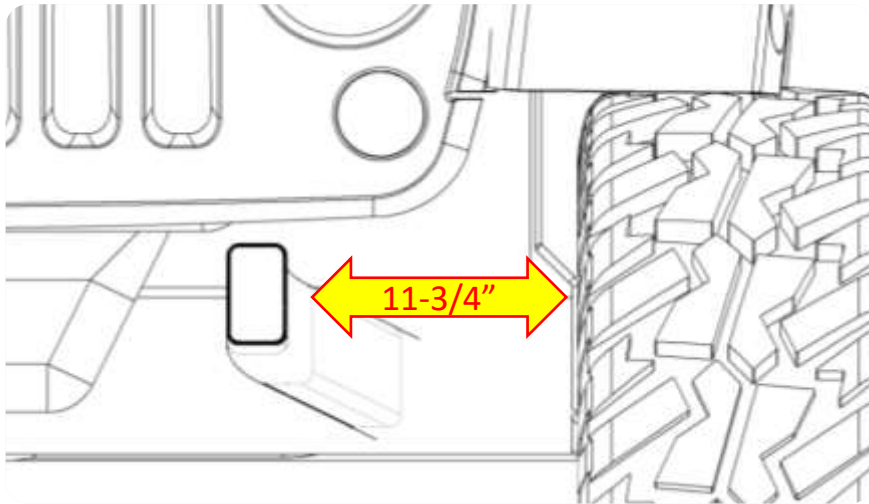

Important Note: MetalCloak provides "rear specific" end-links that have shorter bolt lengths that will keep for optimal fitment.

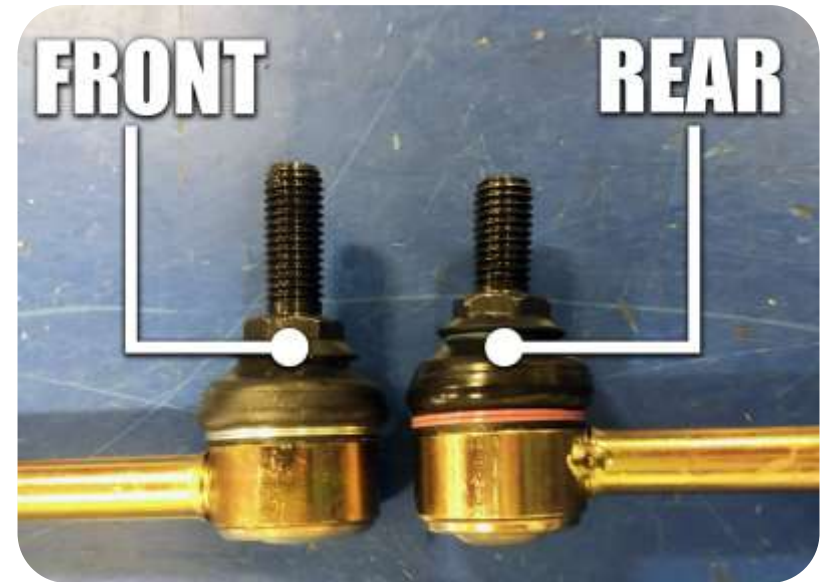

Step 1: Remove Stock Components

- A. Disconnect front sway bar links.
- B. Watch the ABS and brake lines as the axle drops! Unbolt the brake line bracket from the frame and axle in case the lines are stretched while working.
- C. Remove the front track bar, save hardware for re-use.
- D. Remove sway bar end links, save the bottom bolt for use later.

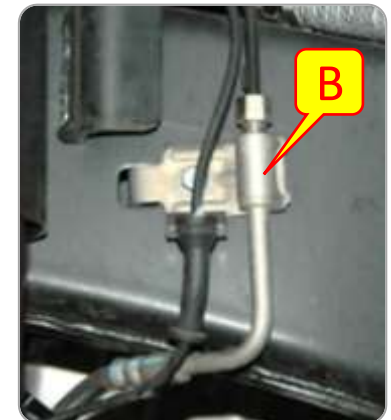

Section 3: Installation Instructions

Step 1: Remove Stock Components

- E. Use a 16MM Wrench on top and bottom to remove the stock nut on top of the upper shock mount tower.
- F. Use a 18MM Socket and Wrench to remove the stock nut and bolt from the lower shock mount bracket located on the axle.
- G. Remove stock springs, and any spacers that have been used if vehicle has been previously lifted. The rubber isolator will be re-used.
- H. Use a 21mm socket and wrench to remove the stock hardware and front lower control arms. Save all hardware.
- I. Use a 18mm socket and wrench to remove the stock hardware and front upper control arms. Save all hardware.

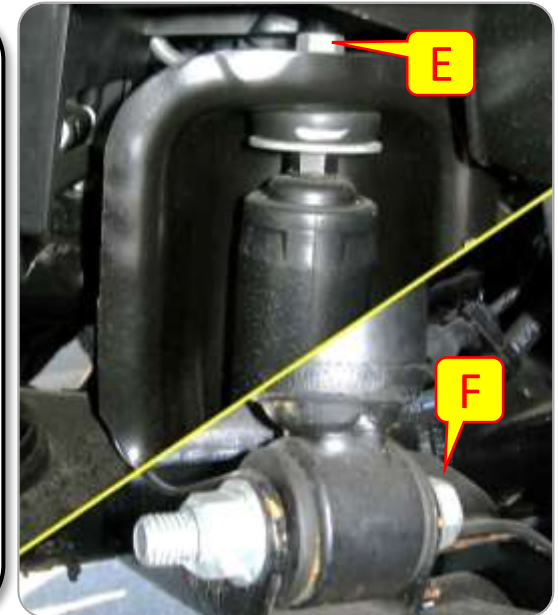

Important Note: The exhaust on the passenger side of some models interferes with removal of the upper bolt. Cut the stock bolt and replace it with the Flange Hex Head Bolt and Hex Flange Nut provided.

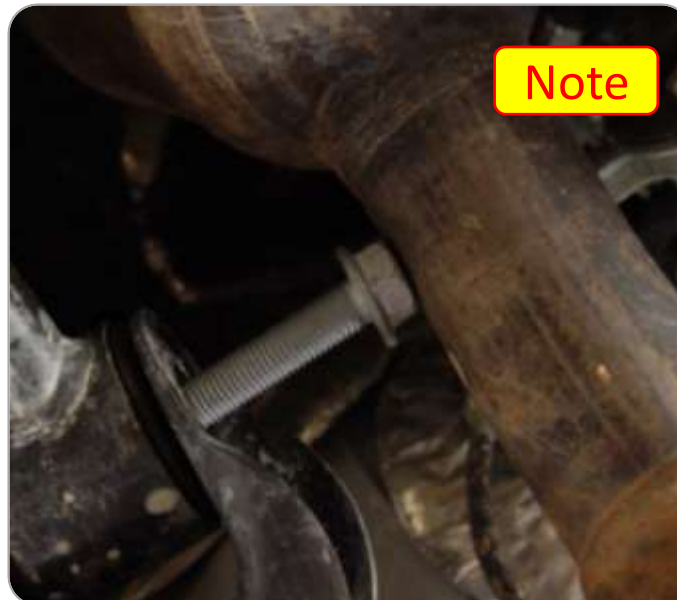

Section 3: Installation Instructions

Step 2: Remove Front Control Arm Brackets

- A. Choose your tool to remove the front upper and front lower control arm bracket at the frame; we use the combination of a plasma torch and a cut off wheel.
- B. Using a grinder grind down the modified areas until flush with the frame.

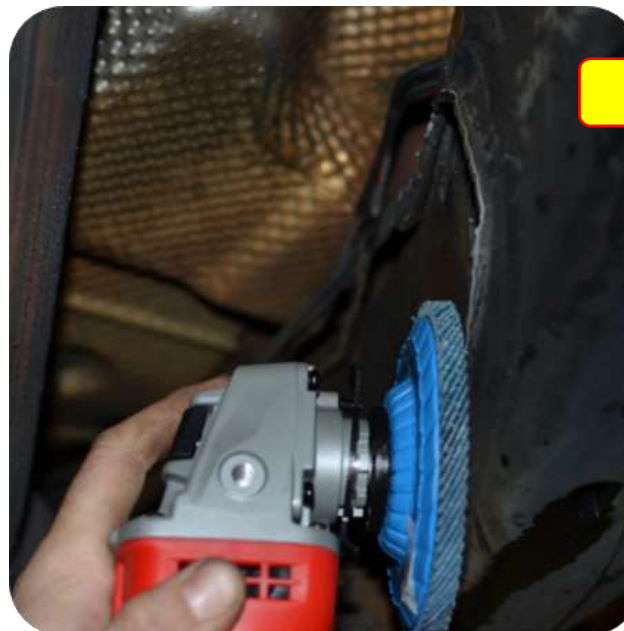

Important Note: We recommend priming and painting any surfaces that the original finish was removed from for corrosion resistance.

Section 3: Installation Instructions

Step 3: Remove Gas Tank

- A. Place a jack or something similar under the gas tank to support it.
- B. Remove the bolts holding the gas tank in place with a 18mm socket.
- C. Remove the gas fill neck by loosening the hose clamp using a 7mm socket.

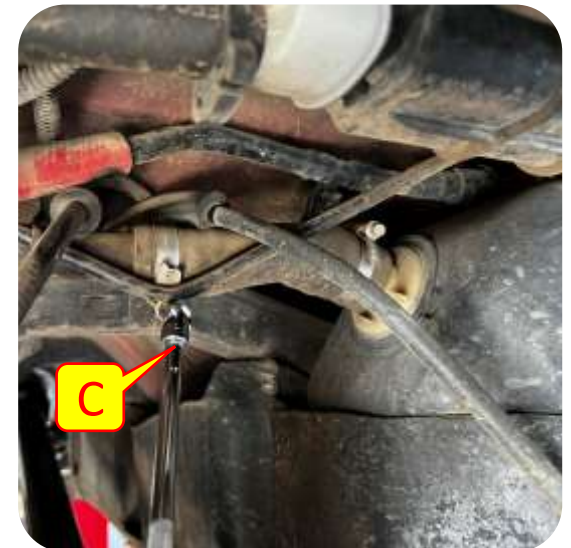
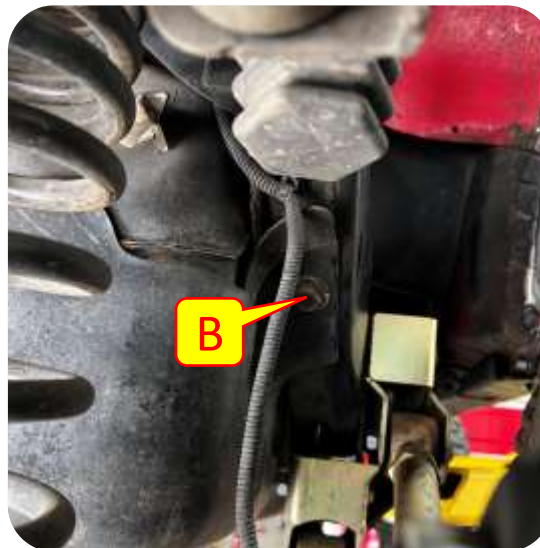
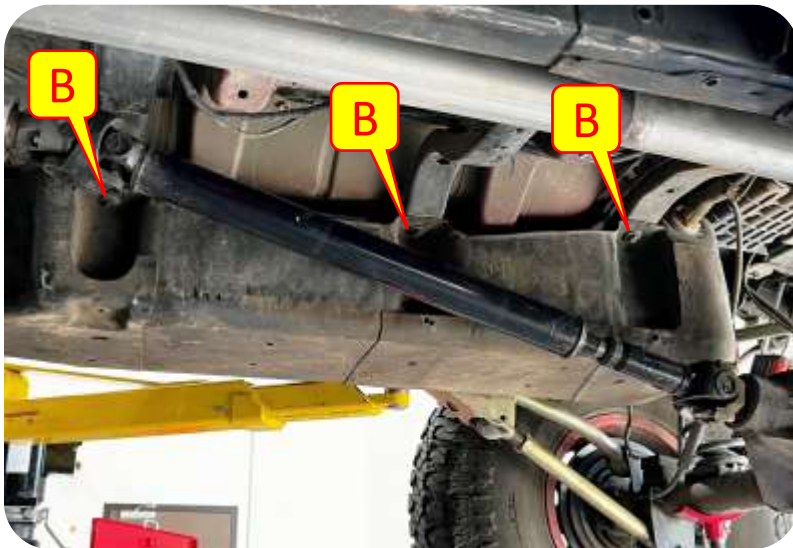
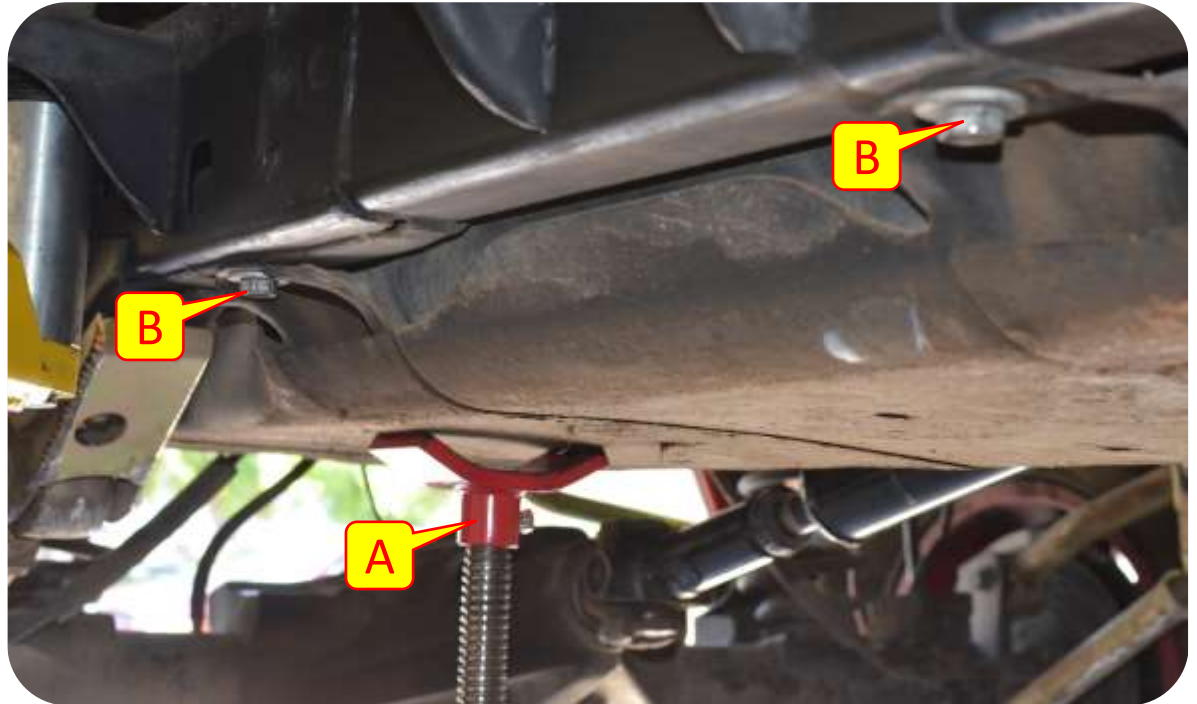

Section 3: Installation Instructions

Step 3: Remove Gas Tank

- D. Remove filler breather by pressing on the line fitting. ****be careful not to break as they are not very strong****
- E. Remove sending unit wiring by pressing on the line fitting (*slide the red clip out and depress the tab and pull gently to disconnect electrical*).
- F. Remove the fuel lines in front of the gas tank by removing plastic retaining clip before pressing down on the line fitting. ****Be careful as these lines may be under pressure and release fuel. We recommend using a container to catch any released fuel to prevent mess.****

Important Note: Move the gas tank at least 25 ft away and make sure the room is well vented as we will be drilling and grinding.



Section 3: Installation Instructions

Step 4: Front Lower Control Arm Brackets

Important Note: On the Driver side cut your exhaust for your chosen loop delete (*Magnaflow Not Recommended*) or relocation kit per their directions and remove the factory loop from the vehicle. We recommend not installing the new exhaust components until after the upper mount is fully installed.

- A. Install the frame crush sleeve into the frame with a swing press. Make sure it goes through both sides of the frame and is sitting flush on both sides.
- B. Insert the large dual flag nuts into the frame through the large square hole in the frame. the lower mount will block this access once it is installed.
- C. Loosely install the 3/4 bolts to help hold the flag nut out of the way during the rest of the install of the lower mount.



Section 3: Installation Instructions

Step 4: Front Lower Control Arm Brackets

- D. Remove the Factory trans skid using 18mm socket.
- E. Support the crossmember with a Jack and remove the two factory bolts from the crossmember using an 18mm socket and wrench.
- F. Install the control arm bracket bolts through the back side of the crossmember and into the bracket and secure with the provide flag nut.

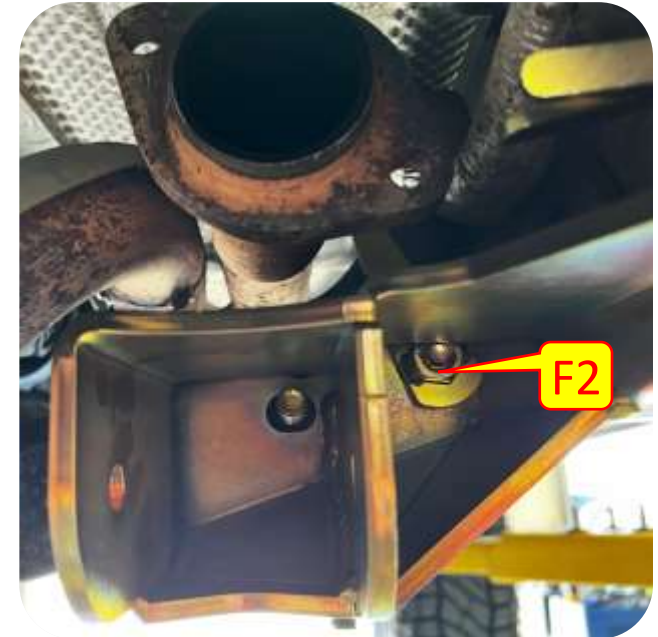

Section 3: Installation Instructions

Step 4: Front Lower Control Arm Brackets

- G. Install factory 18mm bolt into frame weld nut or if the weld nut is not equipped use the provided 1/2" bolt into the flag nut installed in step C.
- H. Install the 1/2" flange bolt, through the large frame backing washer. then through the frame Crush sleeve installed earlier using a flag nut on the bracket side and tighten down using a 3/4" in socket.
- I. Using a 3/4" socket tighten the crossmember mount bolts.
- J. Make sure all control arm bracket hardware is fully tightened.

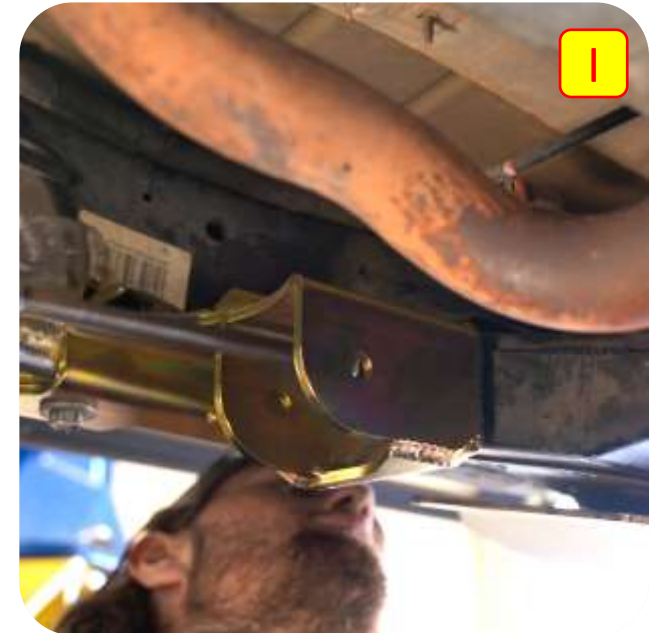

Section 3: Installation Instructions

Step 5: Front Upper Control Arm Brackets (*Weld-On Option*)

Note: *If you chose the bolt on option, you can skip this page and continue to page 12.*

- A. Align mount to frame as pictured and weld. reference hole is bottom 3/4" hold closest to lower mount.
- B. Weld the bracket into place.

Important Note: *We recommend priming and painting any surfaces that the original finish was removed from for corrosion resistance.*



Section 3: Installation Instructions

Step 6: Front Upper Control Arm Brackets (*Bolt-On Option*)

- A. Align Upper arm mount with large holes on the inside of the frame and loosely install both 3/4" bolts into the large flag nut. You can use needle nose vice grips to help grip and position the flag nut if needed.
- B. Use a floor jack or clamp to press up on the bracket to fully seat it with the frame. Also making sure the bracket remaining flush with the lower arm mount to maintain proper spacing of the arms.
- C. Fully tighten the 3/4" bolts using a 1 1/8" socket.
- D. Remove floor jack supporting upper arm mount.

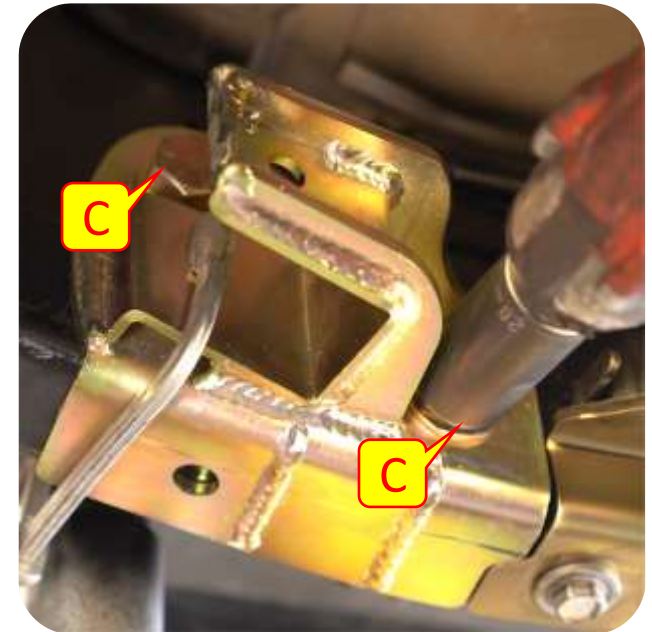
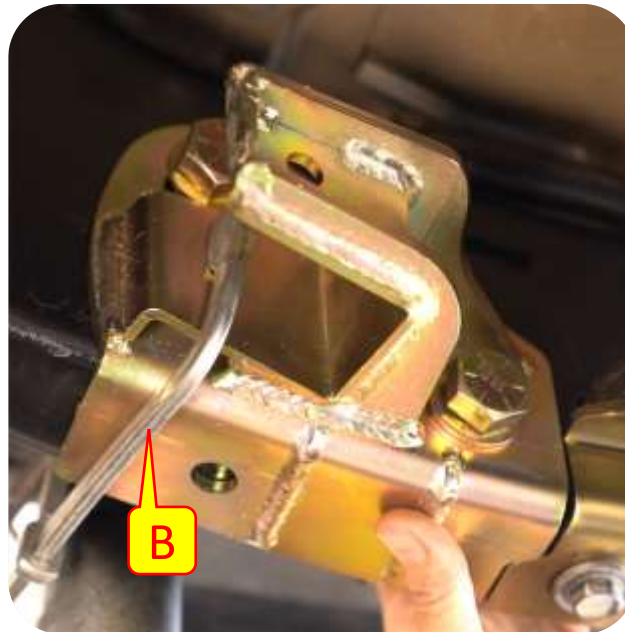
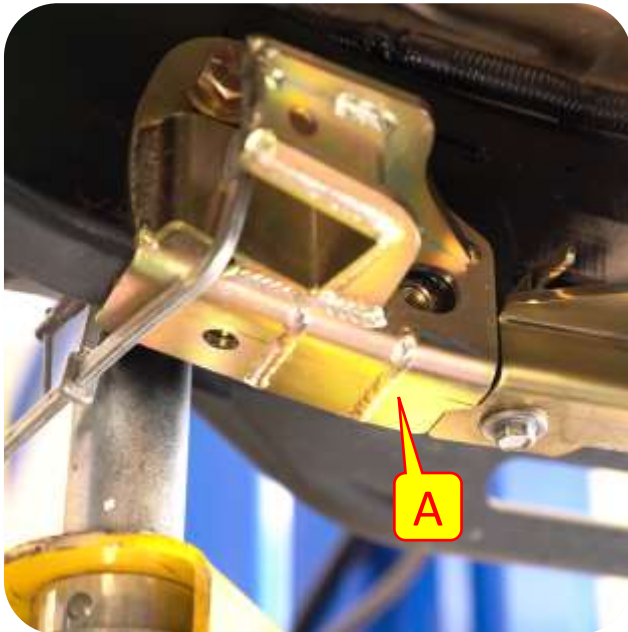

Section 3: Installation Instructions

Step 6: Front Upper Control Arm Brackets (*Bolt-On Option*)

- E. Mark the Hole on the bottom of the upper arm mount and Drill out to 1/2”.
- F. Install the small flag nut through the hole in the frame within the front wheel well; using the provided 1/2” bolt install the bolt through the drilled-out hole on the bottom of the control arm mount and tighten with a 3/4” socket.
- G. Make sure all the upper bracket hardware is fully tightened.

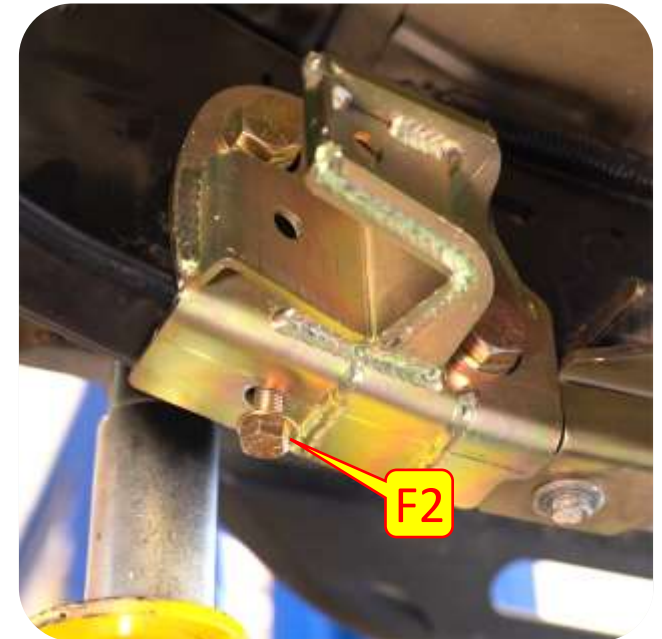
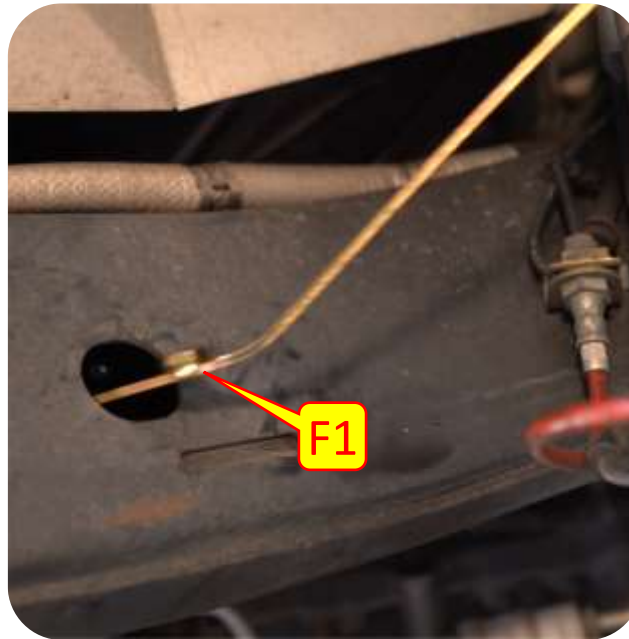
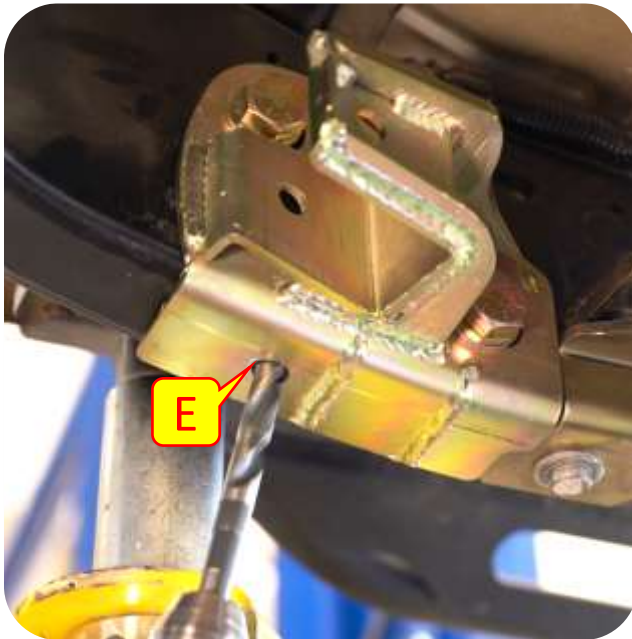

Section 3: Installation Instructions

Step 7: Exhaust Modification

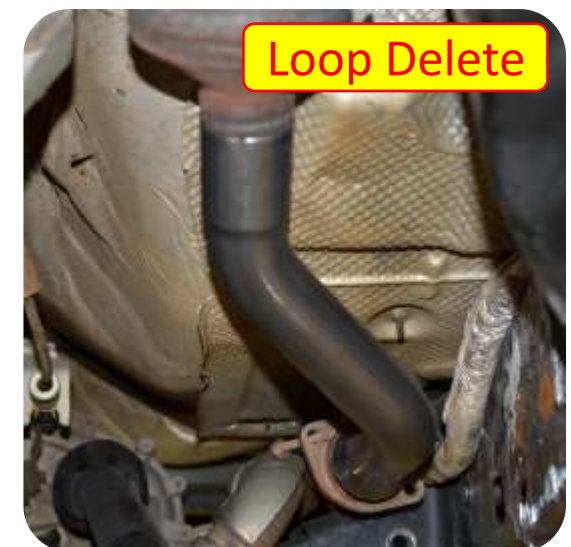
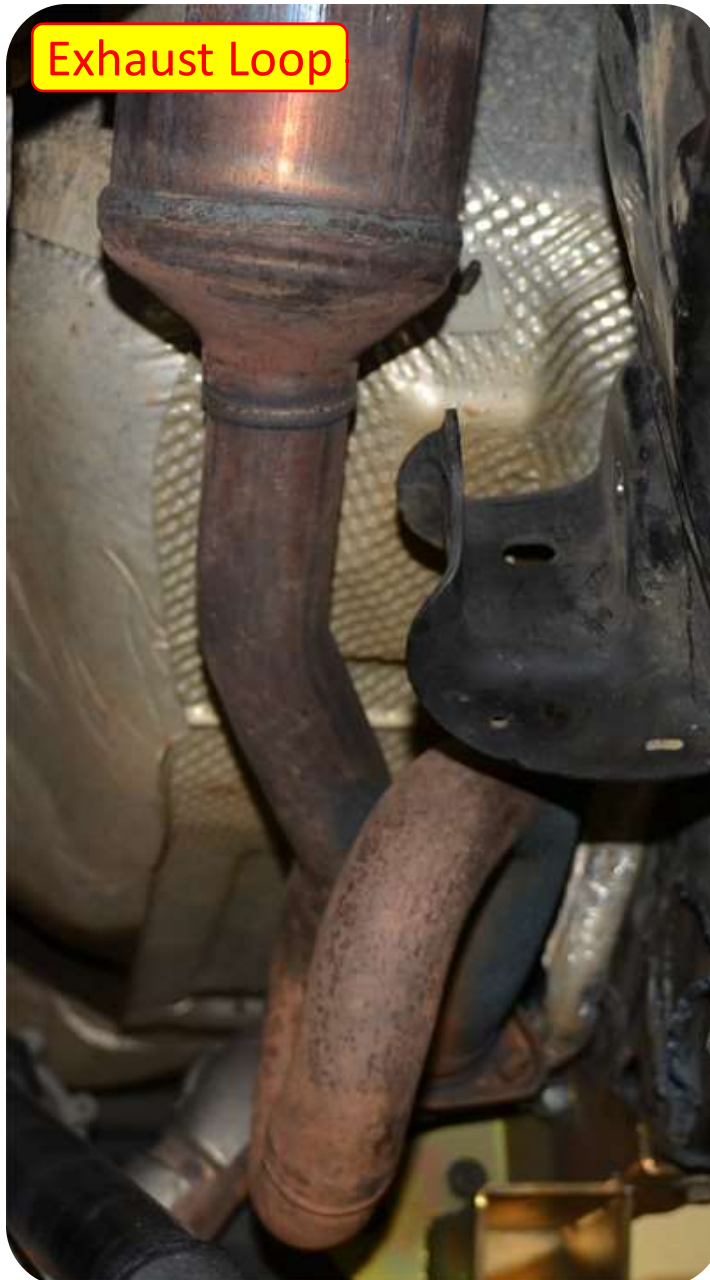

Important Note: *If exhaust modifications need to be performed (exhaust loop delete) now is a good time to do so. Follow MFG instructions on how to modify exhaust. *Exhaust loop delete is NOT included and must be purchased separately.*

Section 3: Installation Instructions

Step 8: Control Arm Installation

- A. Measure the Lower arm to 33" eye to eye (*this is a starting point. Arm lengths may vary*).
- B. Install lower arm with the adjustable side at the frame using the provided 1/2" bolt and nut.
- C. Install the factory bolt and nut at the axle side.

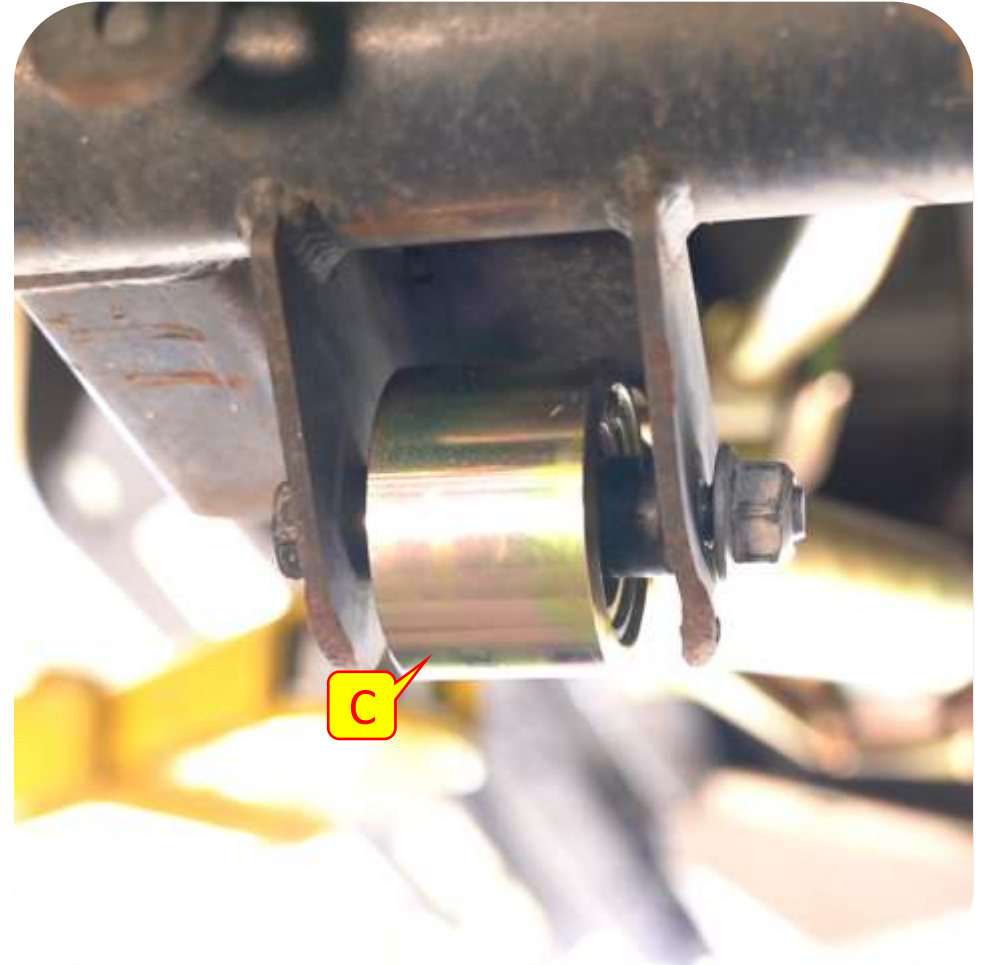
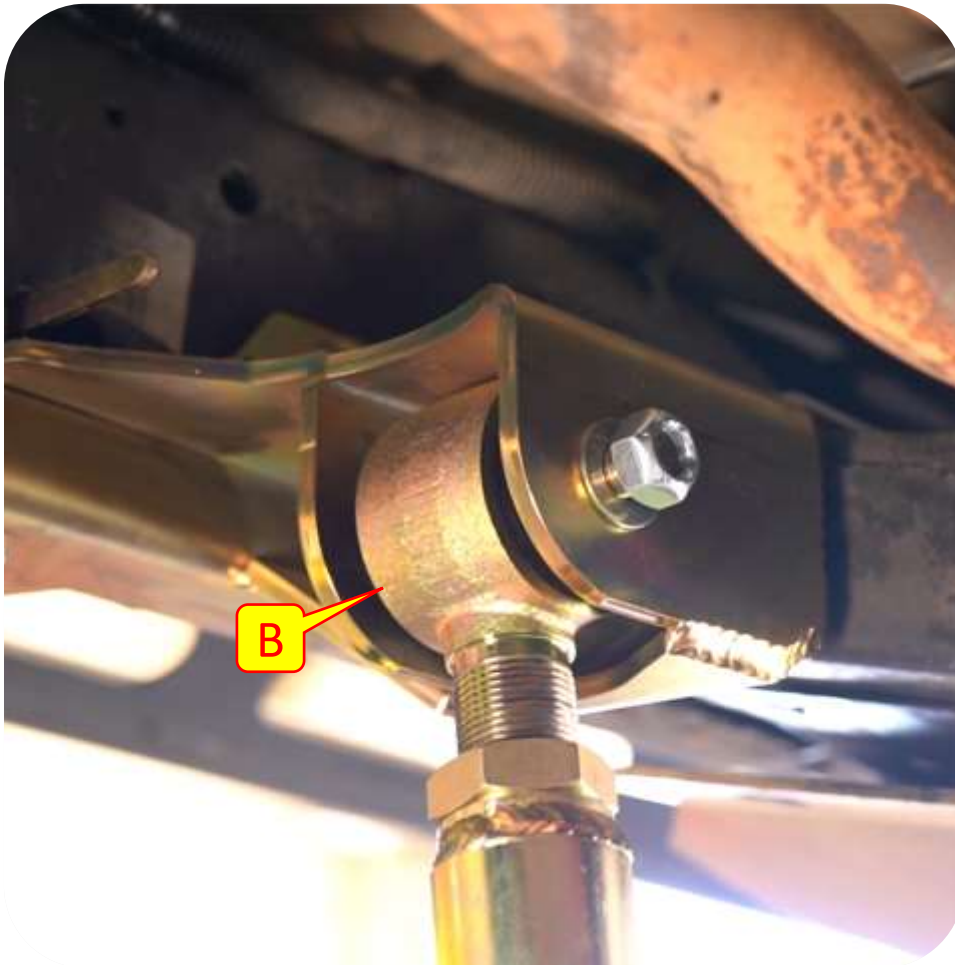

Section 3: Installation Instructions



Step 8: Control Arm Installation

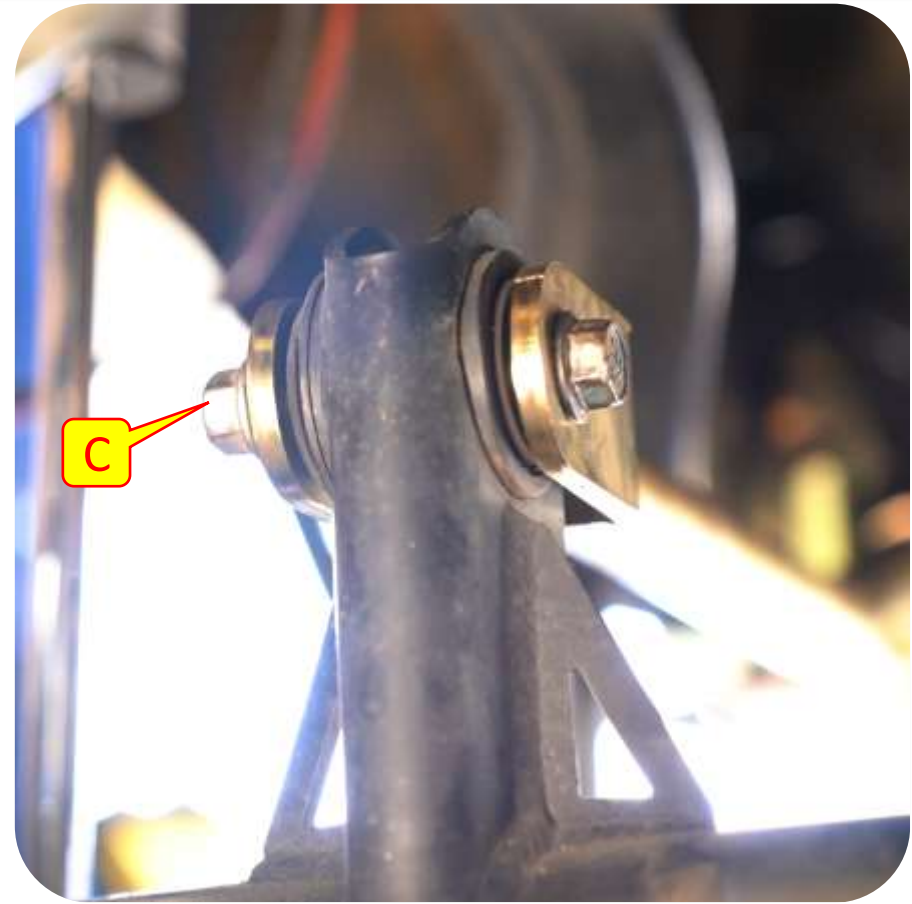

- A. Measure the Lower arm to 27 3/4" eye to eye (*this is a starting point. Arm lengths may vary*).
- B. Install Upper arm to the Upper Frame side bracket and install provided 1/2 bolt and flag nut.
- C. Install the upper arm to the upper axle mount using the factory hardware.
- D. Tighten all control arm hardware.



Section 3: Installation Instructions

Coil Isolator Information Guide

Important Note: MetalCloak's suspension systems include a unique coil design that utilizes upper isolators to position the coil. The following table will help you identify where to install the isolators included with your kit. You must remove the stock isolators before installing the provided coil isolators. If you have any questions give us a call at 916-631-8071.

Coil Isolator Jeep Locations		
Tall Isolator	Jeep Model	Installation Locations
	JL Wrangler 3.6L Non-E Torque	Upper Front Passenger
	JL Wrangler 2.0T E-Torque	Upper Front Driver & Passenger
	JL Wrangler 4xE	Upper Front Driver & Passenger
	JL Wrangler Diesel	Upper Front Driver & Passenger
	JT Gladiator Diesel	Upper Front Driver & Passenger
Short Isolator	Jeep Model	Installation Locations
	JK Wrangler (All Models)	Upper Front Driver & Passenger
	JL Wrangler 3.6L Non-E Torque	Upper Front Driver
	JL Wrangler 3.6L E-Torque	Upper Front Driver & Passenger
	JL Wrangler Turbo	Upper Front Driver & Passenger
	JL Gladiator 3.6L Motor	Upper Front Driver & Passenger
Rear Isolator	Jeep Model	Installation Locations
	JL Wrangler 3.6L Non-E Torque	Upper Rear Passenger
	JL Wrangler 4xE	Upper Front Driver & Passenger

Section 3: Installation Instructions

Step 9: Lowering Axle

- A. Droop your suspension to gain access to the spring perch. Be sure to watch the ABS lines so they do not get over extended and break.

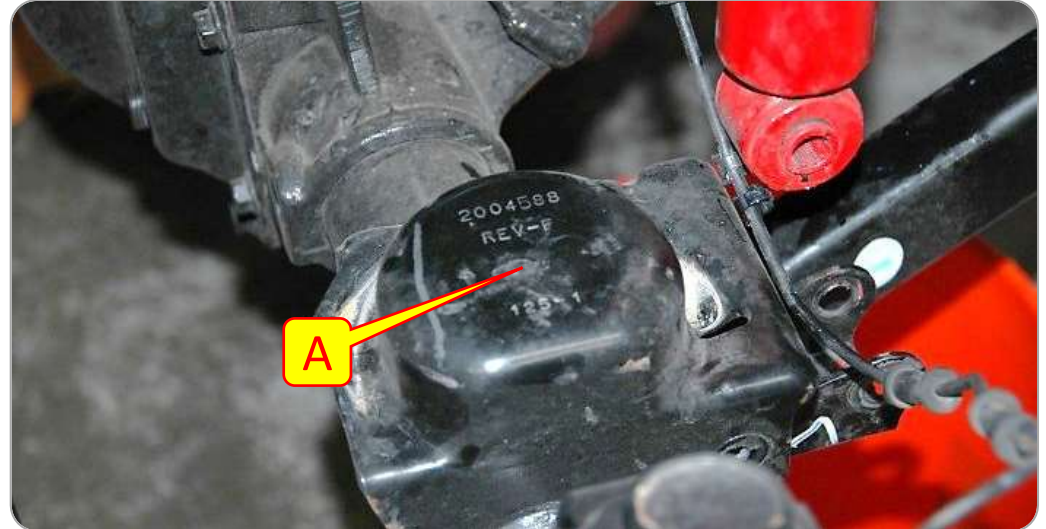

Step 10: Drill Spring Cup

- B. Center a Bump Stop Disk on the top of the spring perch and mark the center of the hole.
- C. Drill a hole at the marked location. You can start your hole with a smaller drill bit and work your way up to a 1/2".

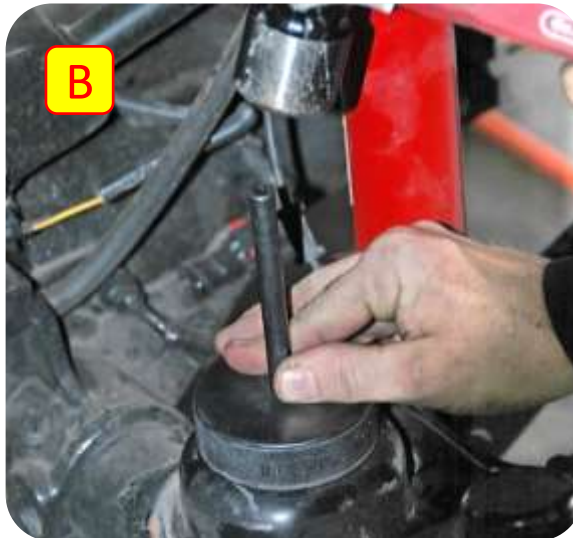

Section 3: Installation Instructions

Step 11: Install Bump Stop

- D. Select the appropriate Screw length so that the threads stick out of the bottom Disks approximately $3/4"$. Assemble your bump stops by feeding the $1/2"$ Countersunk Screw through the Cover Plate, and then threading through the Bump Stop Disks. The center hole in the Disk is intentionally small to create the most rigid assembly possible after installation.
- E. Place the assembled Bump Stop inside the spring before re-installing. Re-install the spring and place the end of the $1/2"$ Screw in the drilled hole.
- F. The $1/2"$ Screw is backed by a $1/2"$ Flanged Nylon Lock Nut. Install the nut and tighten the hardware using a $5/16"$ Hex Key Socket or Allen Wrench and a $3/4"$ Wrench. Tighten until everything is tight; the hardware will not bottom out, but instead will begin to compress the Disks.
- G. Repeat all steps for other side, and then re-install all other suspension components.

Note: *The bump stops may also be assembled in side the coil springs after they are installed.*

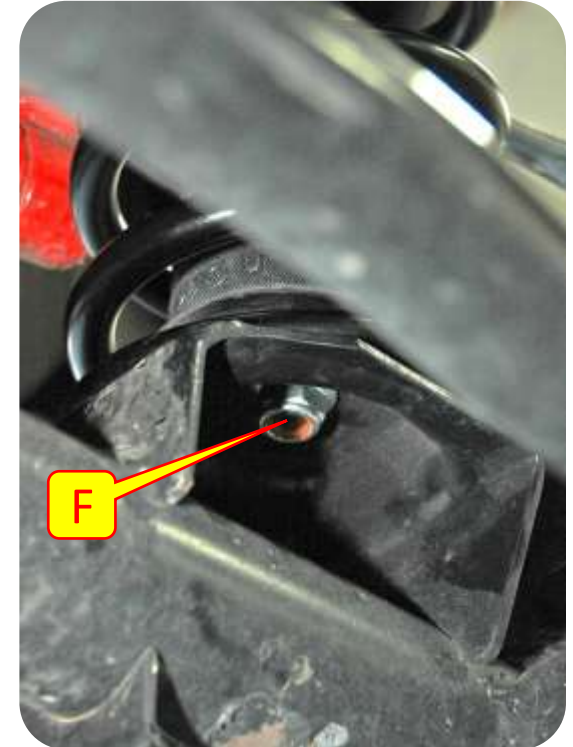

Section 3: Installation Instructions



Step 12: Install Front Coils

- H. If the axle does not “droop” enough to allow the coil to be put in place a coil compressor can be used to compress the coil to allow fitment.
- I. Install Front Dual Rate Coils with the tightly wound coils oriented upward.
- J. Slip the bottom of the coil onto the coil base on the axle.



Section 3: Installation Instructions

Step 13: Install Outboard Shock Spacer Kit

Important Note: If using stock wheels with factory backspacing the outboard shock mount is not recommended as it will interfere with the wheel.

- A. Slide the stock shock bracket into the outboard shock spacer making sure the holes align.
- B. Mark the hole located on the bottom of the shock mount.
- C. Drill out all three holes using a 3/8" drill bit.

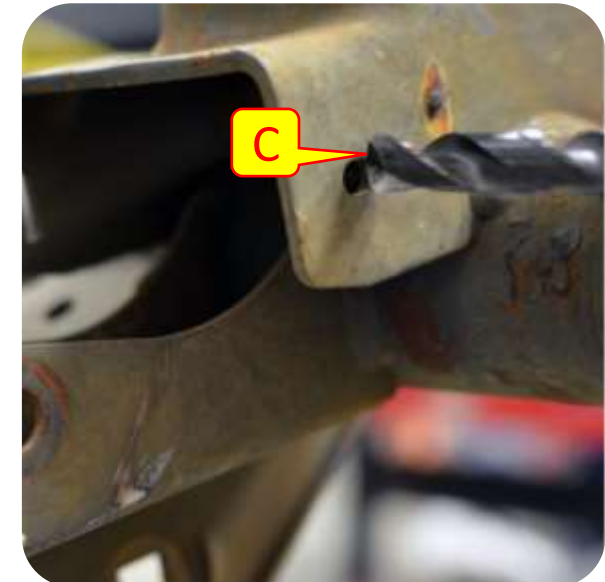
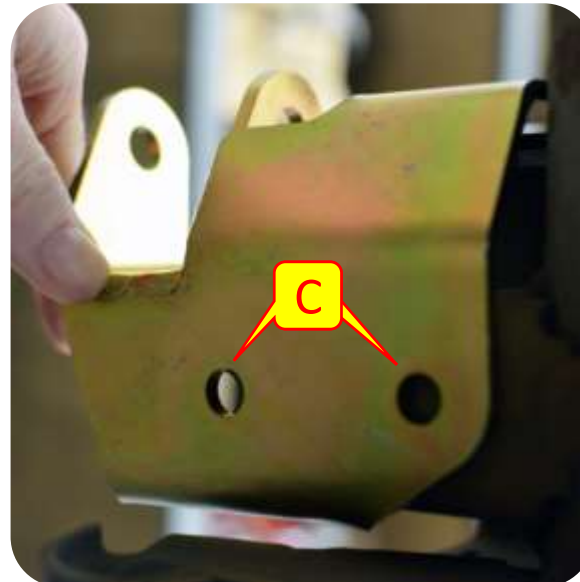
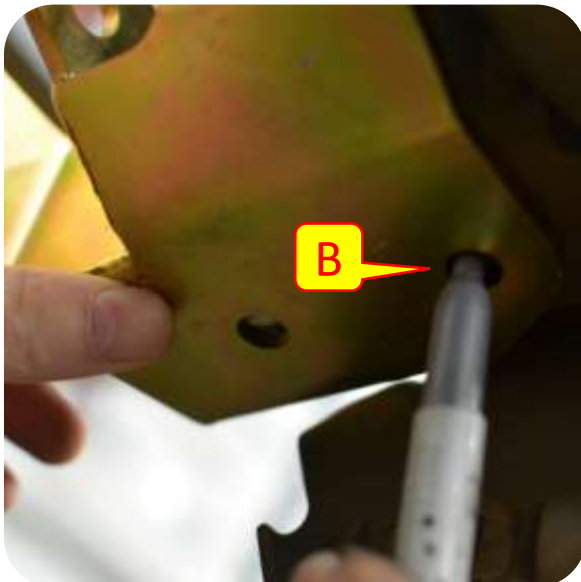
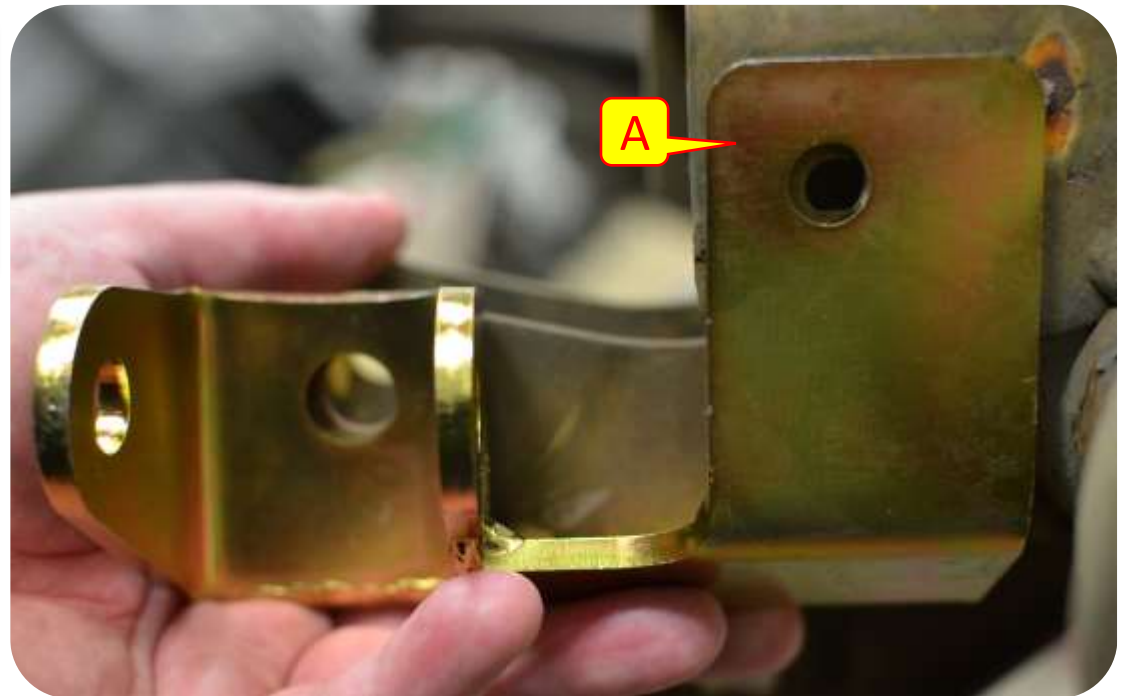

Section 3: Installation Instructions

Step 13: Install Outboard Shock Spacer Kit

- D. Install 2 bottom bolts hand tight.
- E. Install the side bolt hand tight
- F. Insert the spacer in the space between the stock shock mount.
- G. Install spacer bolt and washers.
- H. Tighten all hardware.
Flange Bolts – 14MM Socket & Wrench
Hex Bolts – 19MM Socket & Wrench

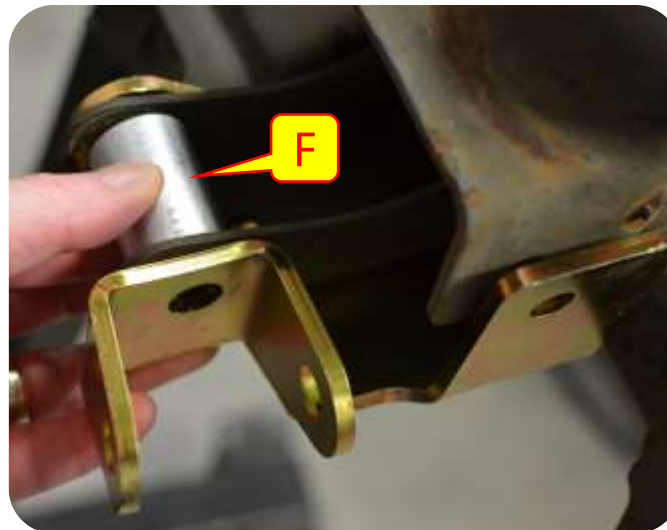
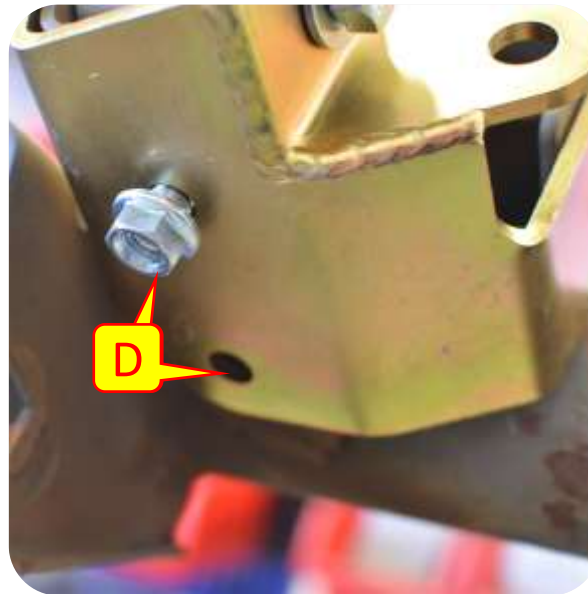

Section 2: FRONT SUSPENSION Installation Instructions



Step 13: Install RockSport Shocks

- E. Remove one nut, washer and rubber spacer from the top of the RockSport shock.
- F. Slip the top of the front shock into the shock tower.
- G. Place the rubber spacer, washer, and nut back onto the top of the shock. And using a 19mm wrench tighten the shock nut to torque specs (20ft. Lbs).
- H. Slip the bottom of the front shock into the New shock bracket.
- I. Slide the stock bolt into place and tighten the bottom shock nut hand tight.
- J. Using a 18mm socket and wrench tighten down the shock bolt to torque specs (56ft. Lbs).

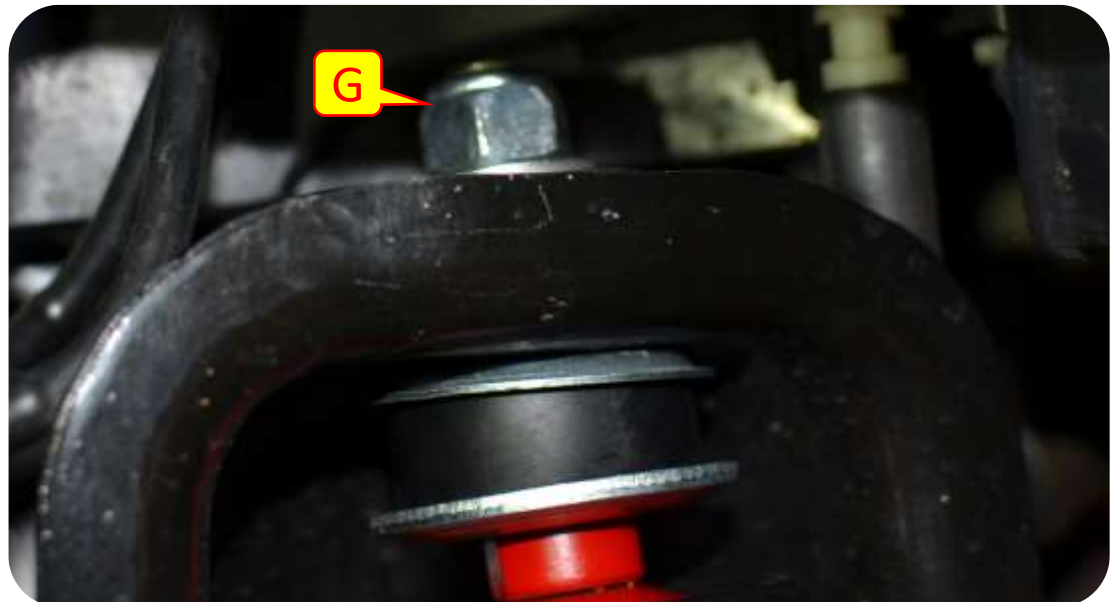

Section 3: Installation Instructions

Step 14: Install Front Brake Line

- A. Use a 15mm Socket to remove the 'banjo' bolt from the brake calipers. Dis-guard the old copper washers. You will want an oil drain pan to catch the brake fluid.
- B. Use a 12mm Wrench to unscrew the stock brake line from the frame bracket.
- C. Unclip the ABS line from the brake line (all the way down), and use a 10mm Socket to remove the bolt holding the stock bracket. Remove the frame clip and brake line discard.

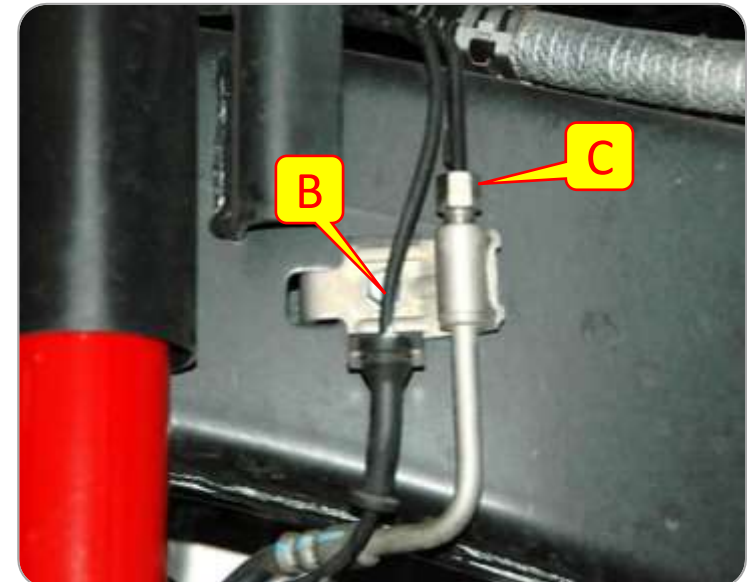
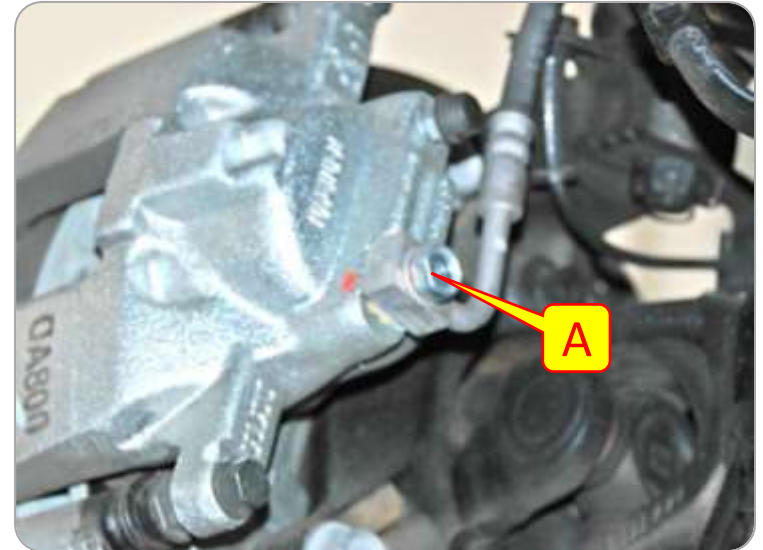

Section 3: Installation Instructions

Step 15: Install Front Brake Line

- D. Place the L-bracket on the frame in the factory location using the factory hardware.
- E. Install the 24-1/2" Brake Line through the bracket.
- F. Screw the stock line into the new Brake Line, and tighten using a 12mm and 17mm Wrench.
- G. Install the provided Spring Clip to retain the Brake Line in the Bracket. You may need a hammer to lightly tap this clip into place.
- H. Use a 1/2" Socket to install the 5/16"-18 Hex Head Self-Tapping Screw. Do not fully tighten.
- I. Feed the banjo bolt through the square end of the brake line. Use the provided brass washers on both sides of the brake line as shown.
- J. Re-install the banjo bolt into the brake caliper.
- K. Zip-tie the ABS lines to the new brake lines.

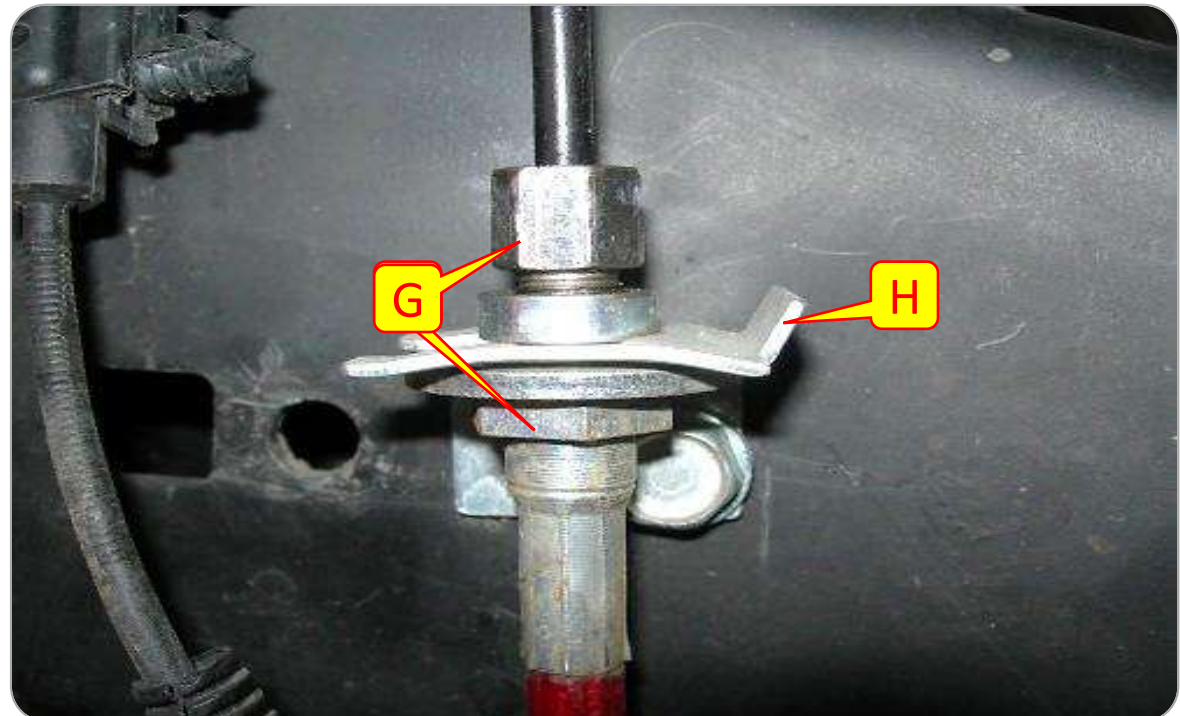

Section 3: Installation Instructions

Step 16: Drag Link Flip Kit

- A. Remove factory drag link from the steering pitman arm and the axle.
- B. Disconnect the axle mount side of the steering stabilizer (*If you have an aftermarket steering stabilizer mount, disconnect the mount*).
- C. Place the Flip Kit Mount over the top of the Axle
- D. Hand Tighten U-Bolt.

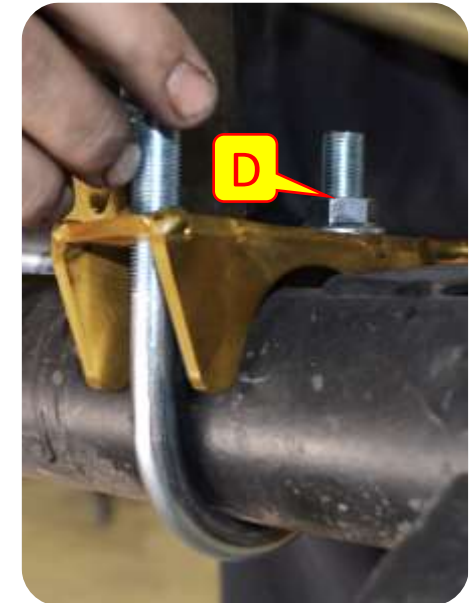

Section 3: Installation Instructions

Step 16: Drag Link Flip Kit

- E. Insert the bottom bolt spacer. It will go into the factory track bar location
- F. Using a 10mm Allen Socket and a 22mm wrench install the bottom bolt.
- G. Adjust Track Bar. As a starting point you can start out at 32 ¾". The adjustment end will go into the axle bracket, this end will also go in once the vehicle is on the ground.
- H. Install track bar using a 14mm socket and a 22mm wrench.
- I. Tighten the U-bolt nuts using a 19mm socket.

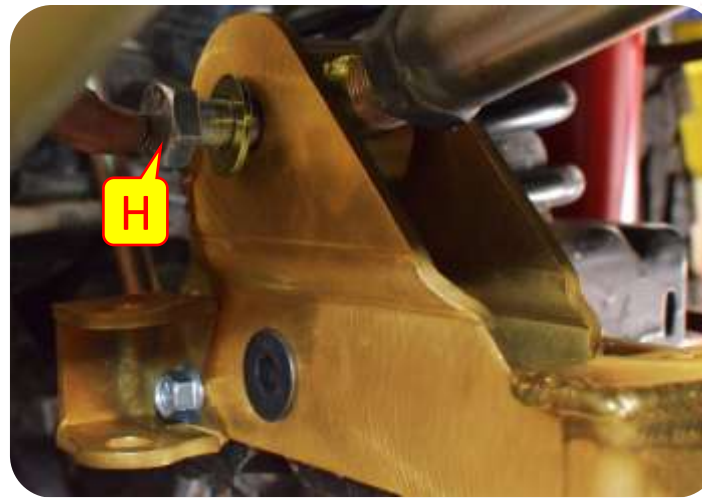
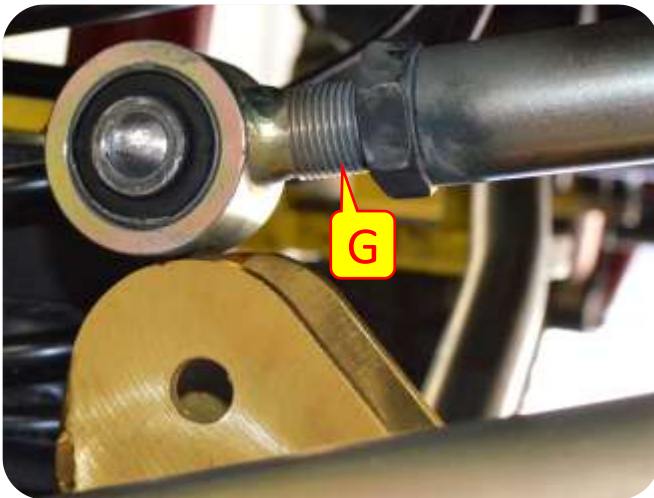
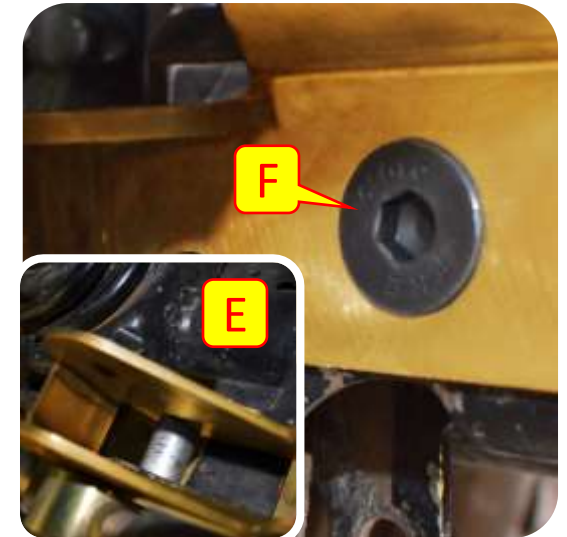

Note: It is helpful to have someone push the vehicle to the driver or passenger side to help align the hole; if you don't have an extra pair of hands you can use a ratchet strap on the frame/axle to pull the frame in the desired direction. Check to ensure the axle is centered once the bolt is in place. If not then remove the bolt, adjust the Track Bar length, replace the bolt, and re-check axle centeredness. Repeat until the axle is as close to center.

Section 3: Installation Instructions

Step 16: Drag Link Flip Kit

- J. Install the steering stabilizer mount bolt and nut using a 9/16" wrench and socket (*insert the nut between the original steering stabilizer mount location*).
- K. Using a 7/8" drill bit drill out the drag link knuckle.

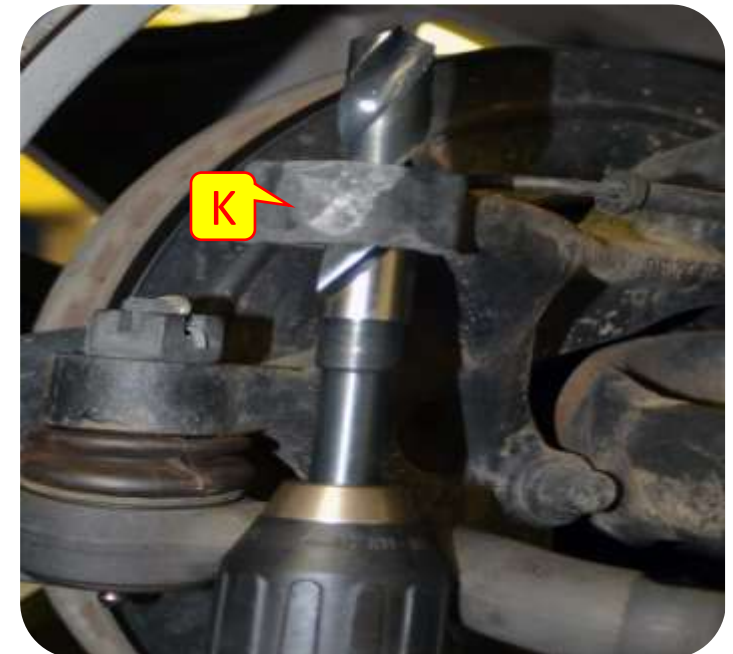
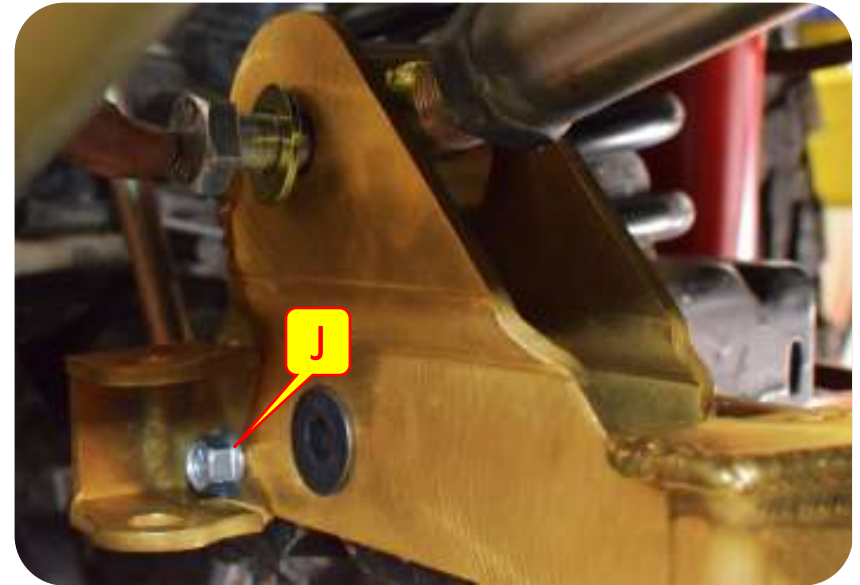

Section 3: Installation Instructions

Step 16: Drag Link Flip Kit



- L. Insert spacer into drilled out hole.
- M. Install new drag link into the knuckle and the steering box pitman arm.
- N. Tighten down drag link nut using an adjustable wrench
- O. Install cotter pin
- P. Install the steering stabilizer into the steering stabilizer mount (*Install the bolt with the nut on top and tighten with a 19mm socket and wrench*).

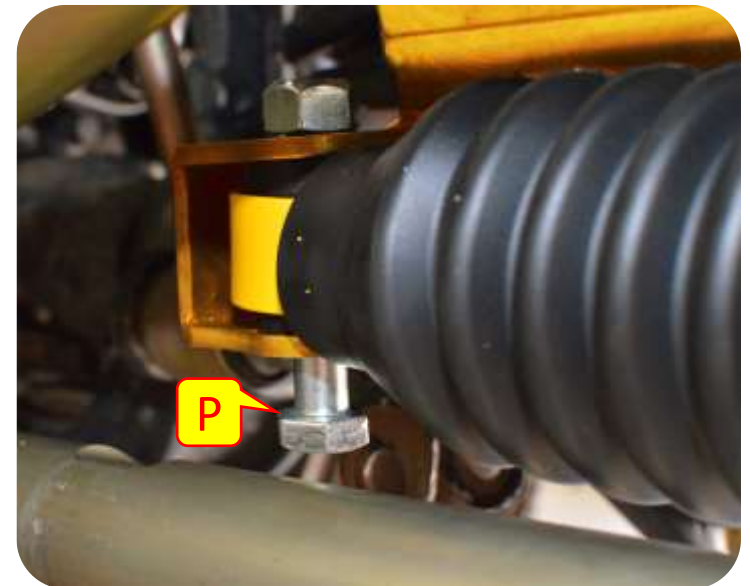
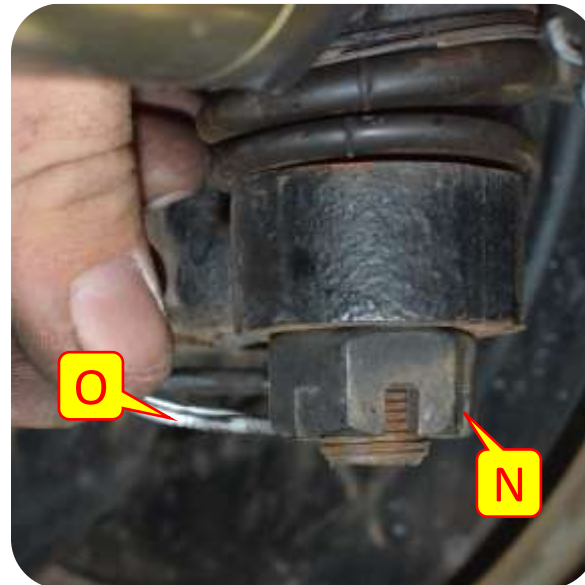

Section 3: Installation Instructions

Step 17: Front Track Bar

- A. The fixed end of the MetalCloak JK Front Track Bar goes in the stock frame bracket. The clearance bends should point toward the front bumper, up and away from the differential cover. Re-use the stock hardware, and only hand tighten the hardware for now (you will fully tighten everything at the end).
- B. The adjustable end of the Track Bar goes into the stock bracket on the axle, again re-using the stock hardware. With the full weight of the vehicle on the springs, push the bolt through the bracket and the Track Bar joint.
- C. Fully tighten the stock hardware on both ends of the Track Bar, and then tighten the Jam Nut on the Track Bar.
- D. MetalCloak **STRONGLY RECOMMENDS** having your alignment checked by a professional after changing any suspension components.

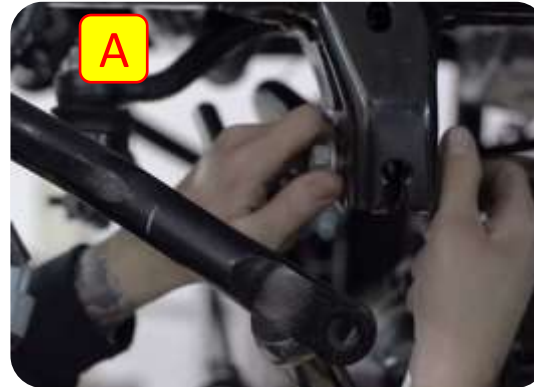

Note: It is helpful to have someone push the vehicle to the driver or passenger side to help align the hole; if you don't have an extra pair of hands you can use a ratchet strap on the frame/axle to pull the frame in the desired direction. Check to ensure the axle is centered once the bolt is in place. If not then remove the bolt, adjust the Track Bar length, replace the bolt, and re-check axle centeredness. Repeat until the axle is as close to center.

Section 3: Installation Instructions

Step 18: Sway Bar Links

- A. Install the lower quick disconnect pin in the stock location. Point the pin toward the center of the vehicle, backed by the provided $\frac{1}{2}$ "-13 hardware. A screwdriver through the hole on the end of the pin is helpful while tightening the nut with a $\frac{3}{4}$ " wrench.
- B. Assemble the sway bar link by threading a jam nut onto the lower link.
- C. Now thread the link into the ball joint. Set the length to 12.25". Do not tighten Jam nut yet.
- D. Install the ball joint on the outside of the sway bar end. You will need a thin $\frac{9}{16}$ " box end wrench to keep the ball joint from turning while you tighten the nut with a $\frac{5}{8}$ " wrench.

Important Note:
MetalCloak recommends using red Loctite on each of the upper spindles of the sway bar end links.

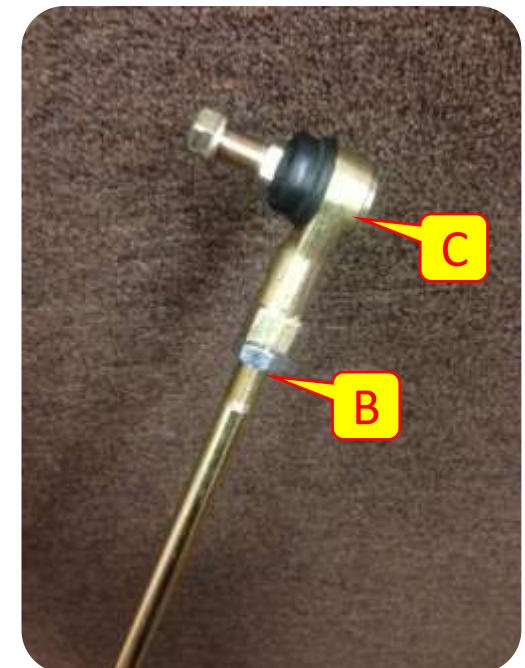
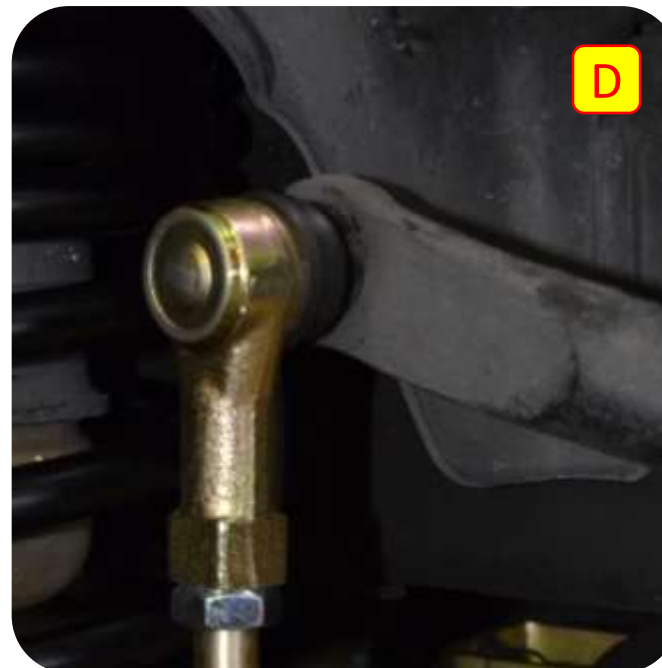
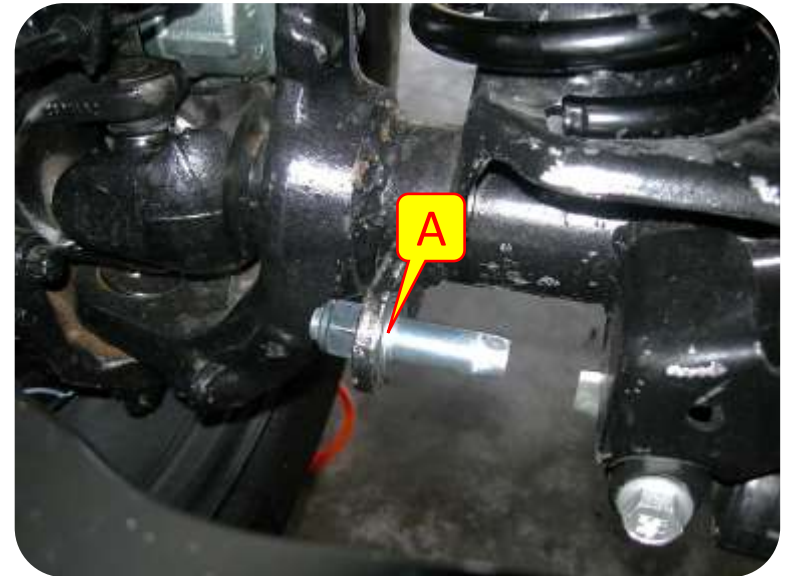

Section 3: Installation Instructions

Step 18: Sway Bar Links

- E. Installed lower rubber bushing on the quick disconnect pin.
- F. Tighten the jam nut.
- G. Disconnect the links and align the provided brackets in the desired location. There is no exact location; the goal is simply to keep the sway bar clear of the tires when stowed. Mark the locations and drill with a 9/32" drill bit. Install the self-tapping screws through the bracket using a 1/2" wrench.
- H. Re-attach the links to the lower pins and install the 1/4" Locking Pins. These may be snug against the rubber bushing, so don't be surprised if you need to use a little muscle to push them through.

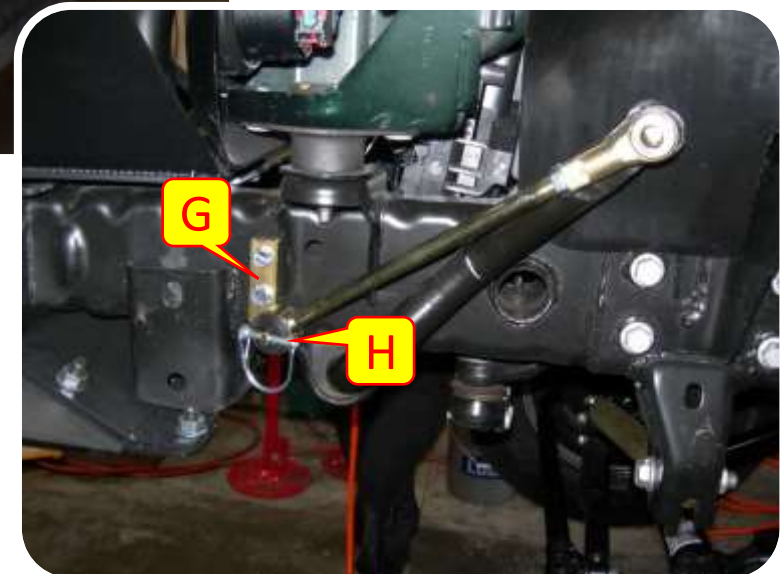
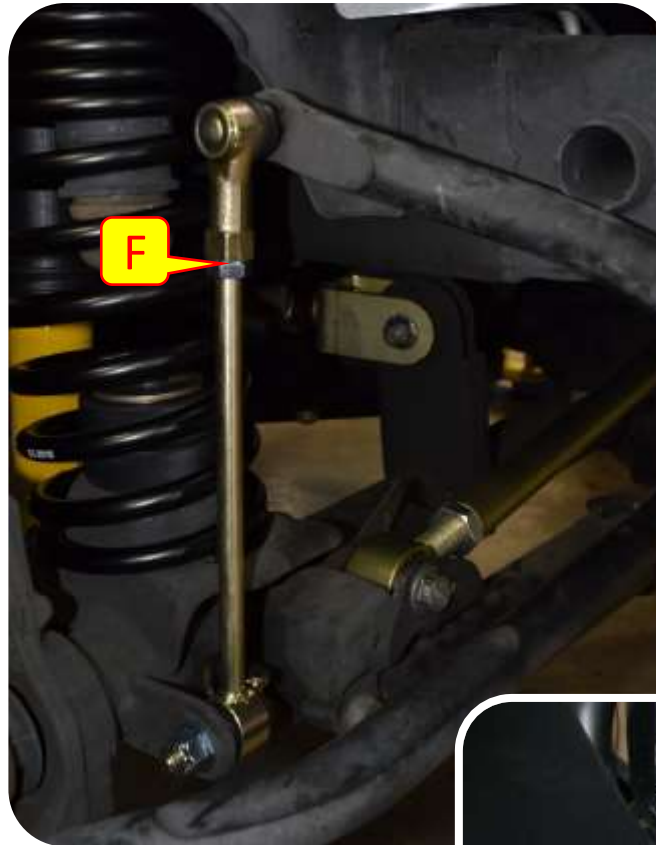

Section 3: Installation Instructions



Step 19: Finalize Installation

- A. Adjust the caster angle and toe as needed. Once set, tighten all hardware. Finally, tighten the jam nuts on all control arms.

Section 3: Installation Instructions

Note: When lifting any vehicle, basic dynamics are changed. It is important for you to take your vehicle to a professional for alignment after installation. When doing so, make sure he is setting caster for lifted vehicle (not stock specs).

Step 1: Remove Stock Components

- A. Disconnect rear sway bar links. Save the lower bolt for later use.
- B. Disconnect rear brake lines. Go ahead and replace the brake lines at this time.
- C. Remove the rear track bar. Save the upper bolt for later use.
- D. Remove the shocks.
- E. Remove stock springs, and any spacers that have been used if vehicle has been previously lifted. The rubber isolator will be re-used.
- F. Disconnect rear control arms. Keep Hardware.

Important Note: Make sure you support the rear axle with jack stands.



Section 3: Installation Instructions

Step 2: Install Rear Brake Lines

- A. The steps to replace the rear brake lines are essentially identical to the front. Use the M6 screw to install the L-Bracket in the stock location, and then install the Brake Line following the same steps as the front.



Step 3: Bleed Brakes

CAUTION!! FAILURE TO PROPERLY BLEED THE BRAKE LINES WILL CAUSE YOUR BRAKES TO BE INEFFECTIVE. Before your vehicle is ready to drive you will need to refill the brake reservoir and bleed the air out of the brake lines. If you are not experienced with this process, or have any reservations, consult a professional. For a full write-up of the brake bleeding process for your JEEP Wrangler JK, you can also refer to <http://project-jk.com/jeep-jk-write-ups/jeep-jk-wrangler-maintenance-bleeding-your-brakes>.

Section 3: Installation Instructions

Step 3: Rear Track Bar Bracket

- A. Slide the MetalCloak Track Bar Bracket in place as shown and re-install the stock bolt through the control arm; do not fully tighten any hardware until the Bracket is fully installed.
- B. Insert the provided Spacer in the axle bracket where the stock track bar was mounted.
- C. Install the provided M14-2x100mm Hex Cap Screw through the stock hole with a Washer under the head of the Screw.
- D. The Screw is backed by a M14 Nylon Jam LockNut and Washer; install but do not fully tighten.
- E. Use a 3/4" Socket to install the 1/2"-20 U-bolt with the provided 1/2"-20 Flange LockNuts. You can snug all the Bracket hardware at this time, but do not fully tighten.

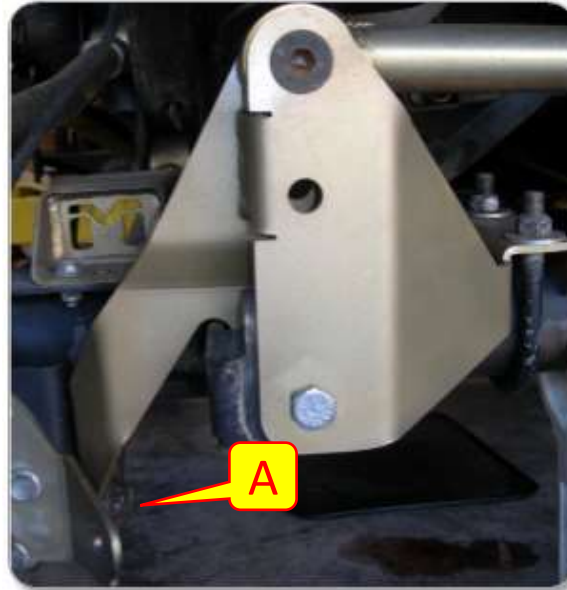

Section 3: Installation Instructions

Step 2: Rear Control Arm Bolt On Bracket Installation

- G. Place the provided drill template onto the frame, measuring a 1/4" away from the front of the seam (*not the weld bead*) and use a c-clamp to hold the drilling template into place. The Chamfer at the top of the template should point to the front of the vehicle close to the body mount. The "P" cut out on the template should be facing outward when drilling the passenger side and the "D" cut out should be facing outward when drilling the driver side.
- H. Mark the holes for drilling.
- I. Center punch the marked holes.
- J. Starting with a smaller drill bit, drill out the four marked locations on the side and one marked location on the bottom and work your way up until you have drilled the locations out to a 1/2". MetalCloak recommends painting any exposed metal to prevent rust.

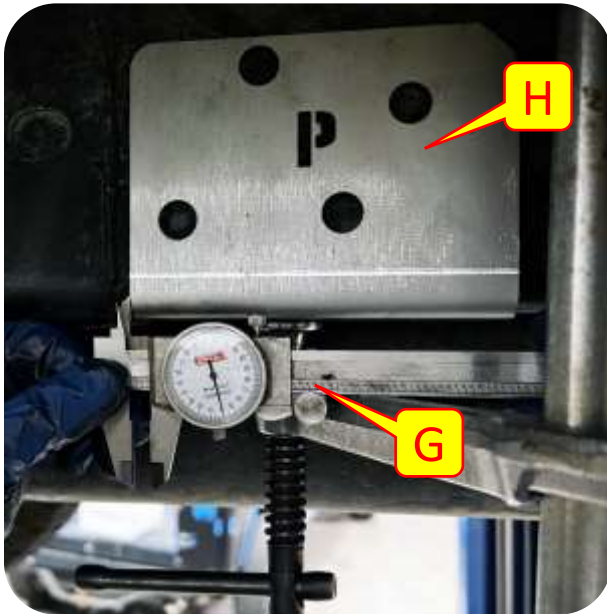

Section 3: Installation Instructions

Step 2: Rear Control Arm Bolt On Bracket Installation

K. Place the control arm bracket shims onto the inside of the rear control arm bracket.

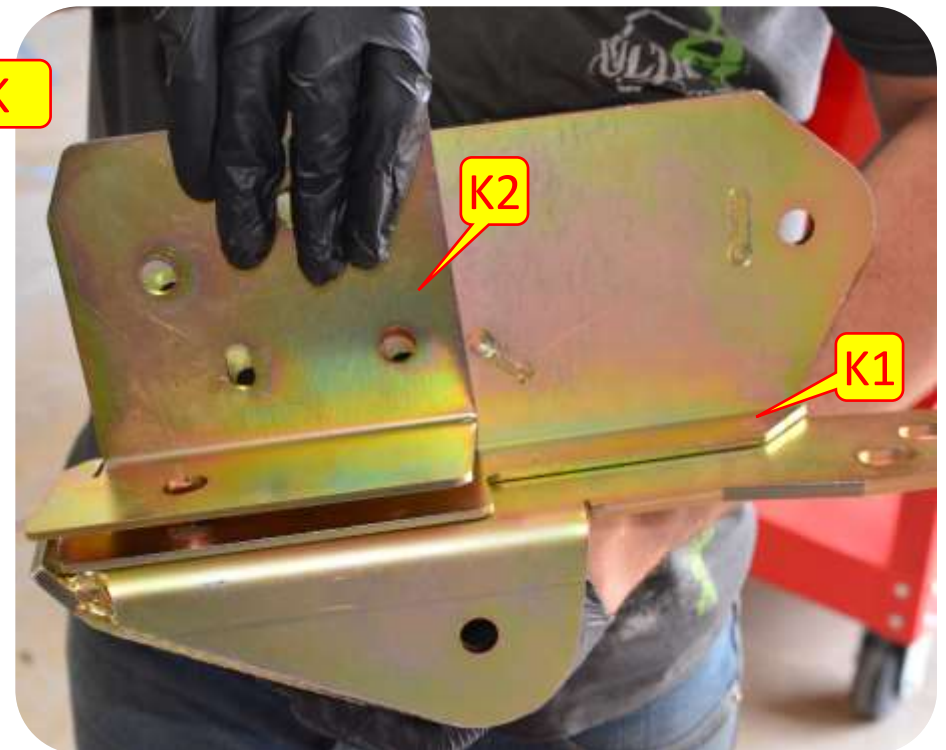
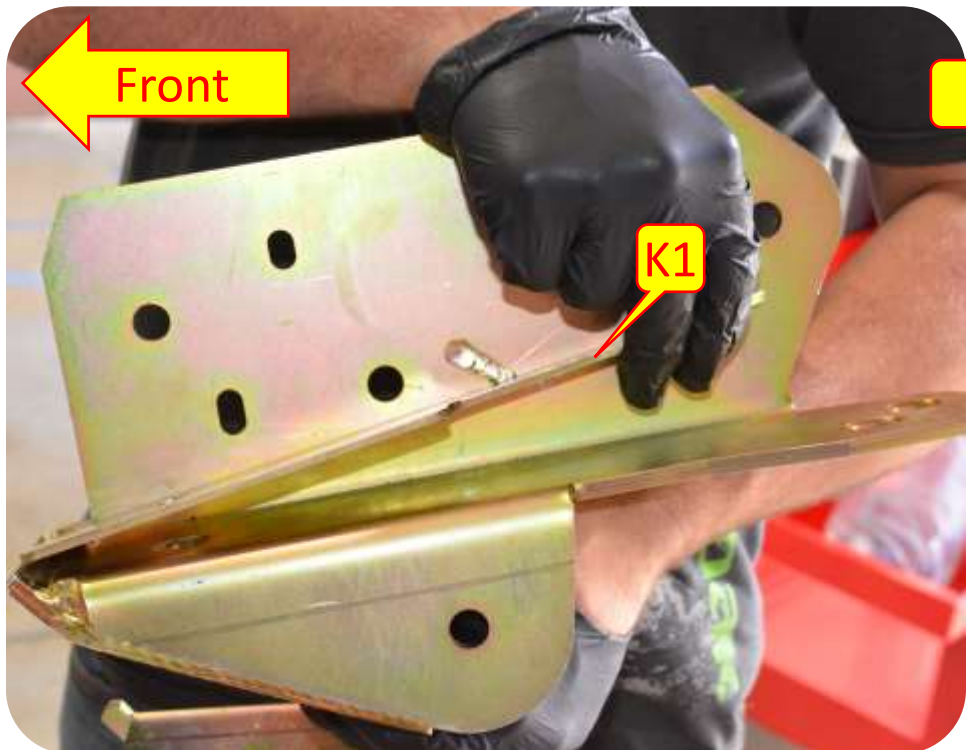

Section 3: Installation Instructions

Step 2: Rear Control Arm Bolt On Bracket Installation

- L. Using the factory 18mm bolt, line up the long arm frame bracket and install loosely (*passenger side only*).
- M. Install the WM-5893 (BOM #8) flag nut through the hole on the inside of the frame and install the provided 1/2" (3/4" head) bolt into front most hole into flag nut and hand tighten.
- N. Install the WM-5892 (BOM #9/#10) flag nut through the hole on the inside of the frame and install the 2x 3/8" (9/16" head) bolt into middle set holes and into flag nut and hand tighten.
- O. Install the WM-5891 (BOM #11) flag nut through the hole on the inside of the frame and install 1/2" (3/4" head) bolt into rear most hole into flag nut and hand tighten.

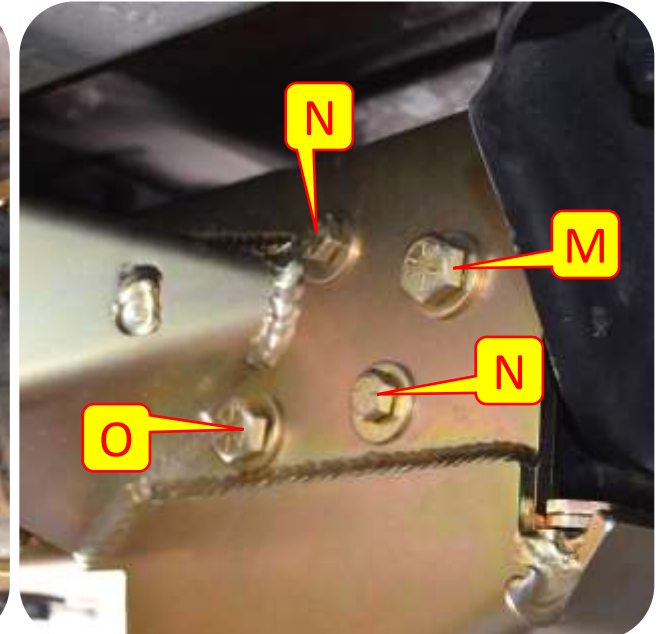

Section 3: Installation Instructions

Step 2: Rear Control Arm Bolt On Bracket Installation

- P. Insert straight flag nut (*BOM #5*) into opening on the inside of the frame and install the 1/2" (3/4" head) bolt into front bottom hole into flag nut.
- Q. Tighten the bracket hardware using a 3/4" socket for the 1/2" hardware and a 9/16" socket for the 3/8" hardware.

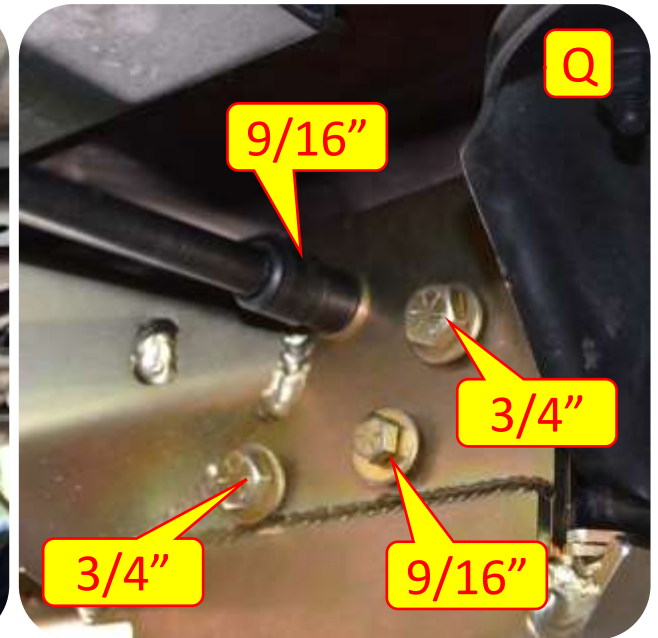
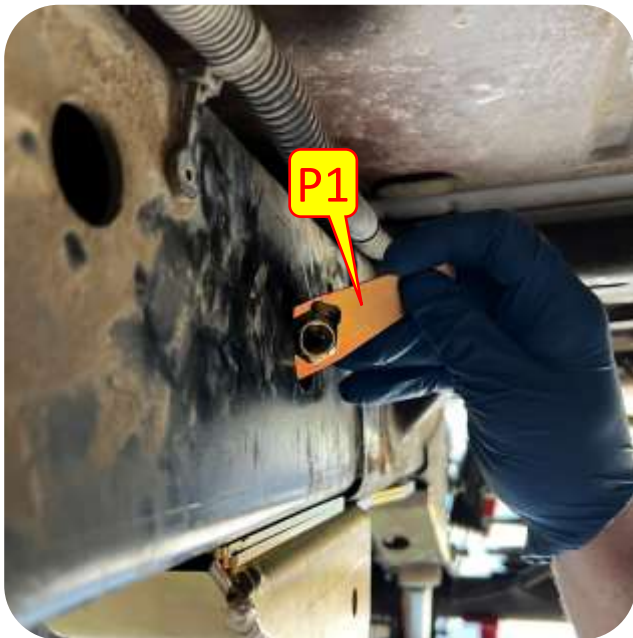

Section 3: Installation Instructions

Step 2: Rear Control Arm Bolt On Bracket Installation

- R. Remove the rear control arms using a 21mm socket and wrench.
- S. Remove the existing rear control arm brackets from the frame, clean the frame and paint the left-over exposed metal.
- T. Drill out the remaining hole on the side rear of the control arm bracket, using the bracket as the reference (*On the driver side only you will also be drilling the hole at the bottom rear of the bracket marked JK*).

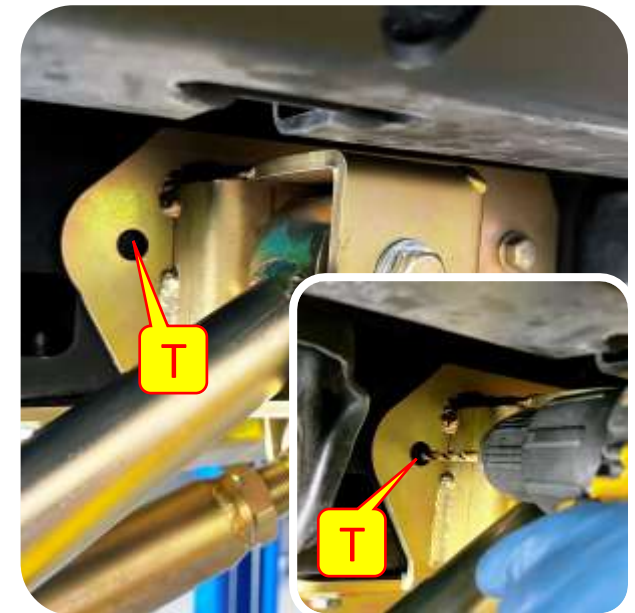
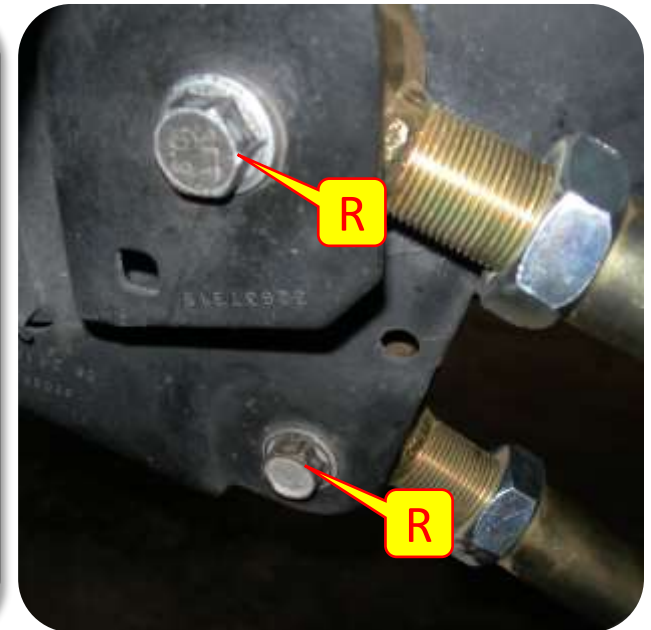

Section 3: Installation Instructions

Step 2: Rear Control Arm Bolt On Bracket Installation

- U. Install the longer flag nut WM-5894 (BOM#12) from the rear, using the hole made accessible from the control arm mounts that were just removed and install the provided 1/2 (3/4" head) bolt in the side of the rear mount, hole just drilled and tighten with a 3/4" socket.
- V. **Driver Side Only:** Install the long flag nut WM-5895 (BOM#13) from the rear, using the hole made accessible from the control arm mounts that were just removed earlier and install the provided 1/2" (3/4" head) bolt in the bottom of the rear mount, hole just drilled. Tighten with a 3/4" socket.

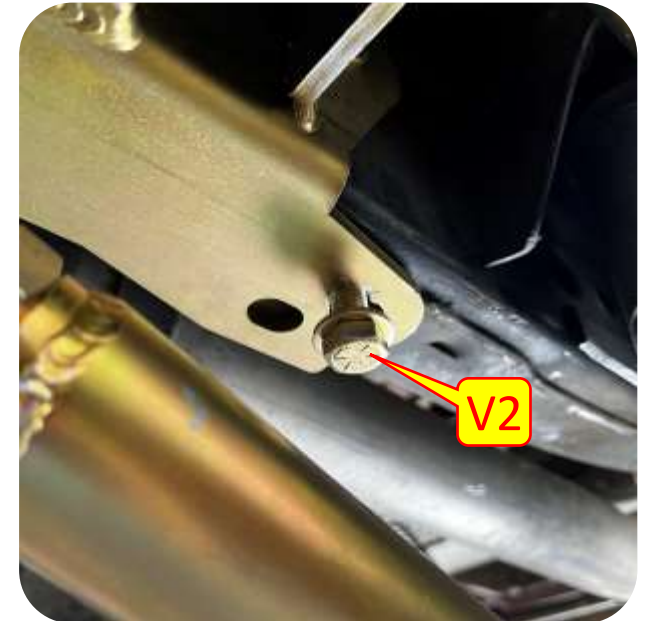
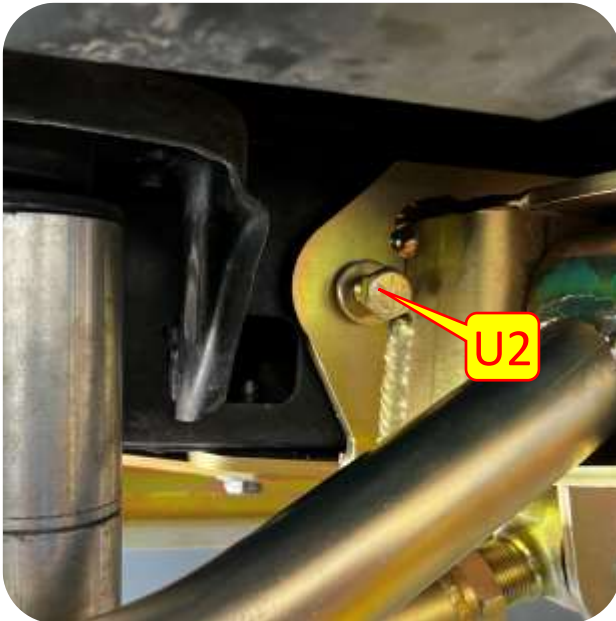

Section 3: Installation Instructions



Step 3: Important Notes

Important Note: If you're installing the rear long arm kit with our UnderCloak system. Check to see if the UnderCloak system will mount without modification. If the UnderCloak does not fit the gas tank skid plate will need to be modified, you will need to notch out the gas tank skid plate and reinstall the skid plate (See Last Page for Instructions).

Important Note 2: Cut off the gas tank mount as shown. Make sure there is plenty of ventilation before cutting the mount off.



Section 3: Installation Instructions

Step 4: Reinstall the Gas Tank

- W. Reinstall the gas tank, reconnect the fuel lines, breather tubes, Evap Canister hose, fuel tubes, and bolts (*reverse steps B-F*) and install the MetalCloak fuel skid if previously equipped.
- X. Tighten the Gas tank bolts using an 18mm socket. **DO NOT forget the bolt at the rear of the passenger side mount installed in step L.** Tighten with a 18mm socket.

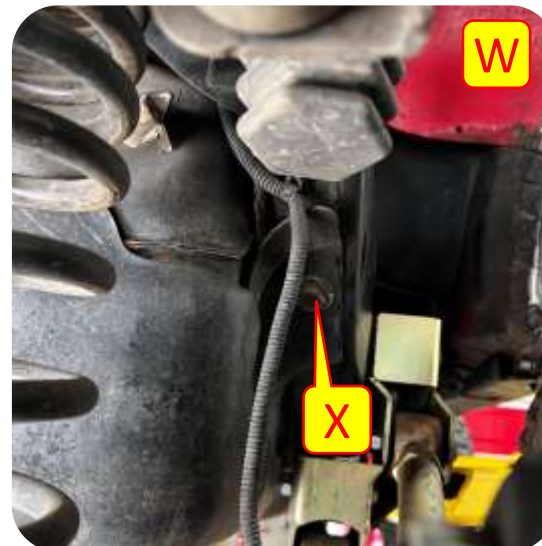
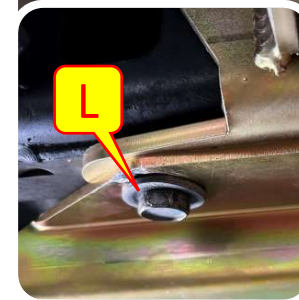
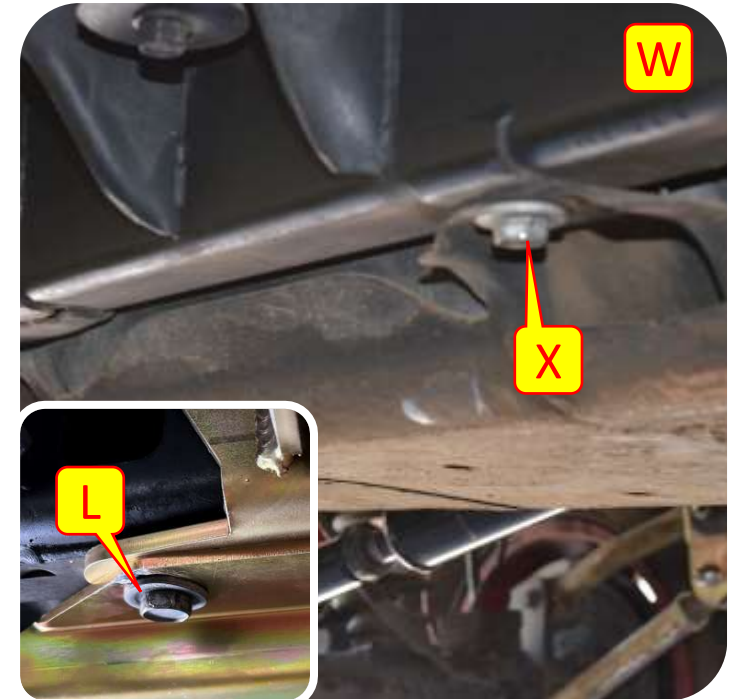

Section 3: Installation Instructions

Step 5: Install Long Arms

Control Arm Starting Points

Rear Lower Control Arm: 38 1/4" eye to eye

Rear Upper Control Arm: 32 1/2" eye to eye

- Y. Install the lower control arms orientating it so that the lock is toward the frame, using the provided 9/16" hardware and a 15/16" socket and wrench at the frame end and the factory hardware using a 21mm socket and wrench at the axle end.
 - Z. Install the upper control arms, orientating it so that the lock nut is toward the axle, using a 15/16" socket and wrench at the frame end and the factory hardware using a 21mm socket and wrench at the axle end.
- AA. Repeat steps on the driver side.

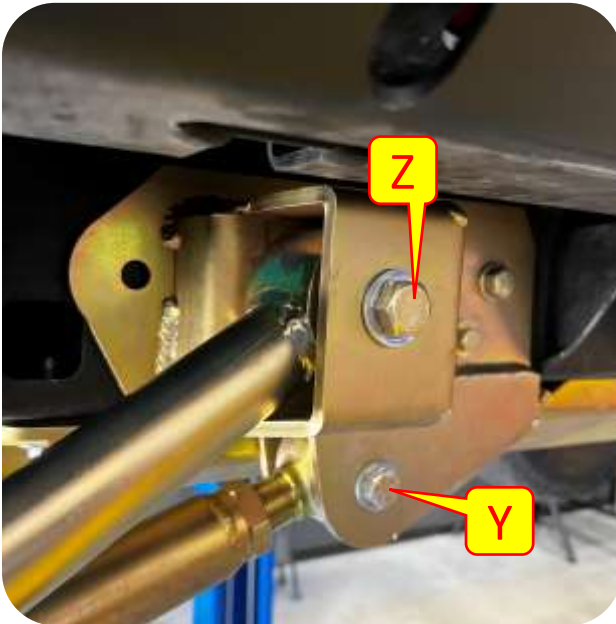

Section 3: Installation Instructions



Step 7: Modifying the UnderCloak Gas Tank Skid

The Following Step is ONLY if you have the MetalCloak UnderCloak System that needs to be modified.

To modify your UnderCloak Gas Tank Skid Plate measure 1.5" up from the bend line to the cut out for factory arms. from this point measure forward 17.2" in parallels to the bend line (dash line) and then up to the edge of the skid at a 135 deg angle. measure forward 12.8" and draw a circle approximately 1.5" diameter this is to clear the hardware on the long arm mount. Using a cutoff wheel cut along the line (green line). These Measurements are starting points you may need to modify your skid slightly to fit properly.

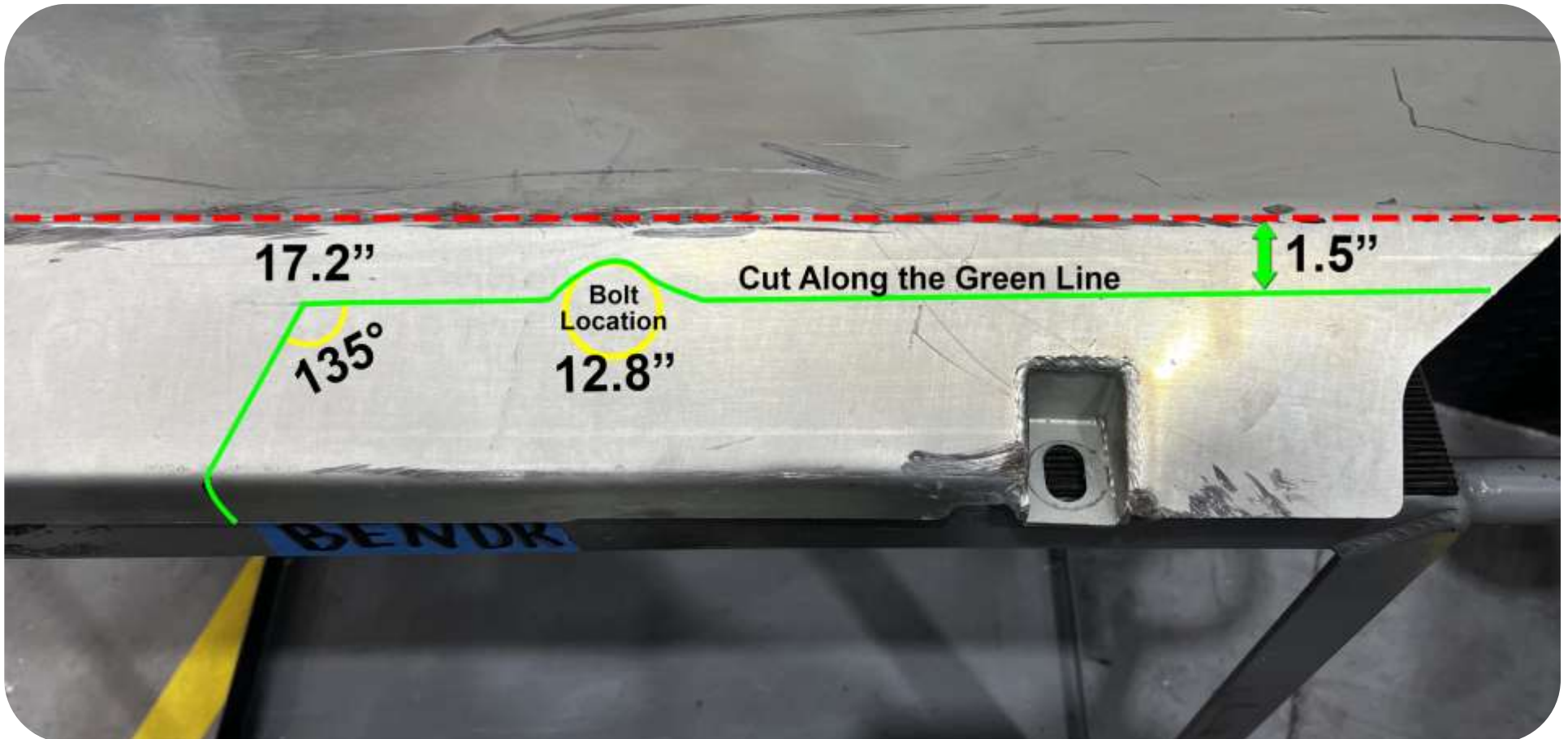

Section 3: Installation Instructions



Step 5: Install MetalCloak Track Bar

- A. Pre-set the length of the MetalCloak Track Bar to 40-1/8" eye-to-eye. This length can be adjusted for your specific build.
- B. Install the MetalCloak Track Bar using the stock hardware. On the bottom the BOLT HEAD should face REARWARD, and on the upper mount the NUT should be to the rear. Tighten all hardware.

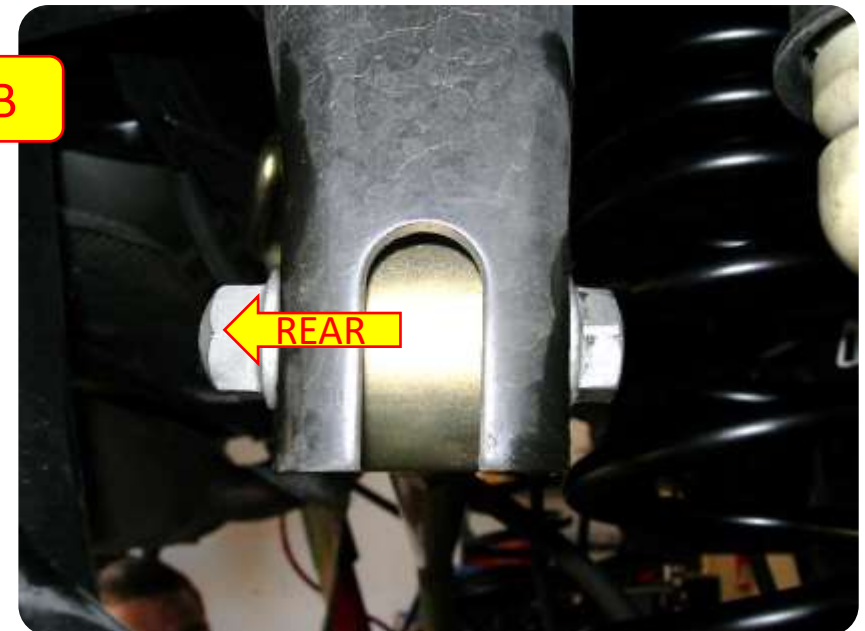
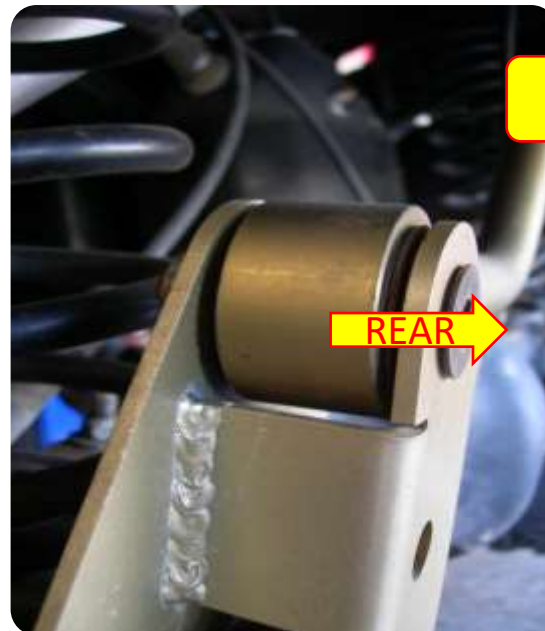
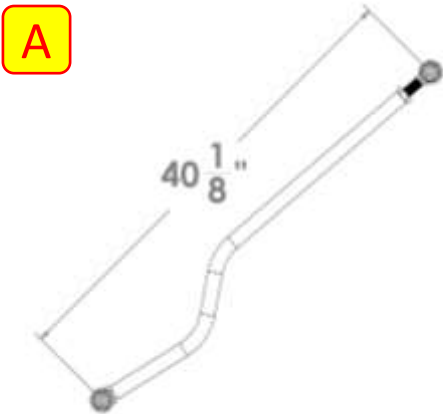

Section 3: Installation Instructions

Step 6: Install Rear Coils & Spring Retainer

- A. Place the coil spring correction plate onto the rear coil bucket.
- B. If the axle does not “droop” enough to allow the coil to be put in place a coil compressor can be used to compress the coil to allow fitment.
- C. Place the Rear Coil Cup on top of the Rear Dual Rate Coil.
- D. Install Rear Dual Rate Coils with the tightly wound coils oriented upward.
- E. Slip the bottom of the coil onto the coil base on the axle.

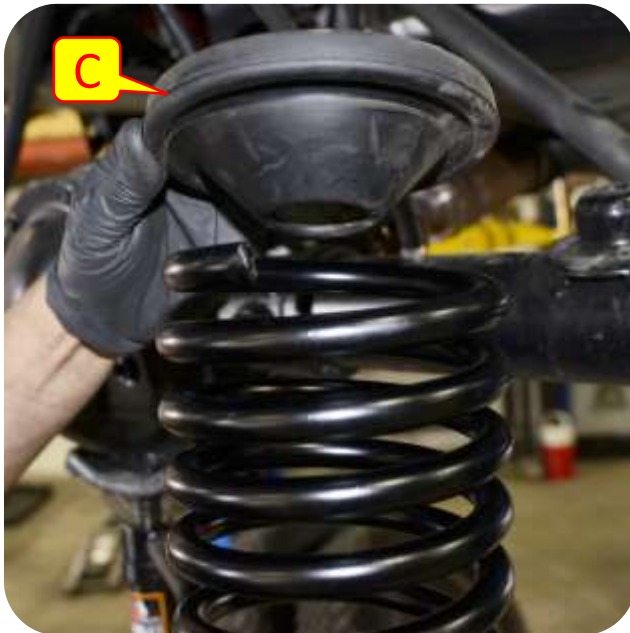
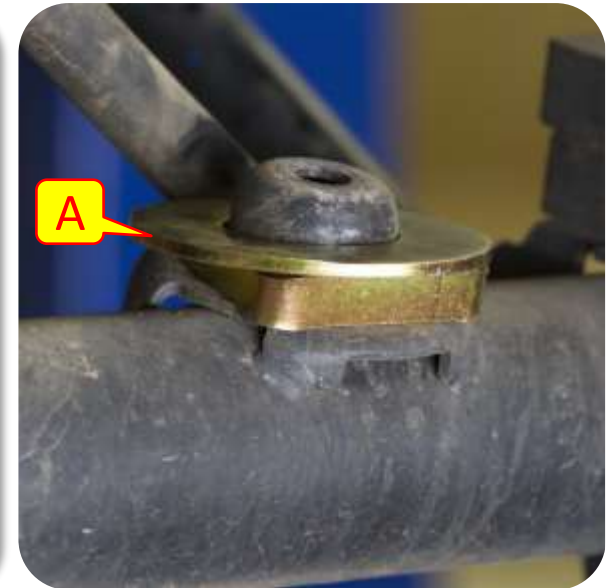

Section 3: Installation Instructions

Step 6: Install Rear Coils & Spring Retainer

- F. Install Retainer Washer onto the top of the coil bucket.
- G. Place the Coil Retainer Plate onto the top of the coil spring tail.
- H. Insert the provided bolt and washer into the coil retainer plate and coil bucket.
- I. Insert the flange nut into the coil bucket and start to thread the flange nut onto the spring retainer bolt.
- J. Using a 19mm wrench tighten down the spring retainer bolt.
- K. Repeat Steps for other side and reinstall disconnected components.
- L. Install rear shocks.

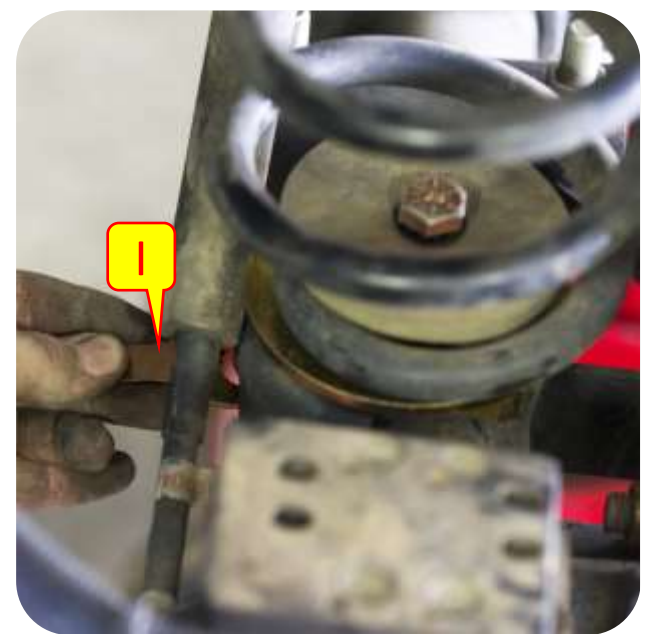
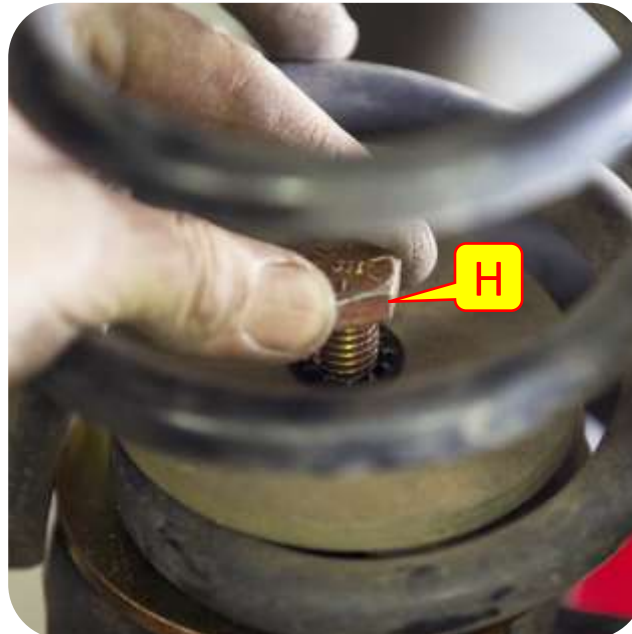

Section 3: Installation Instructions



Step 7: Install Rear Sway Bar

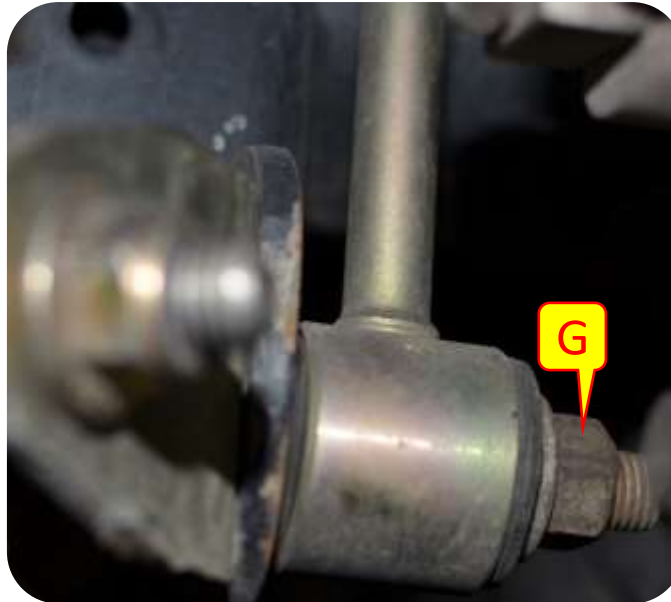

- G. Using the factory hardware install the bottom of the MetalCloak extended sway bar links.
- H. Using the factory hardware install the top of the MetalCloak extended sway bar links.
- I. Torque upper and lower bolts to 75lbs.

Section 3: Installation Instructions



Step 8: Install Rear Shocks

- D. Locate the MetalCloak Lower Shock Mount Bracket (Bracket is symmetrical and can be reversed for Driver and Passenger Side) using the stock holes. The lower hole of the “figure 8” opening of the Shock Mount Bracket aligns with the stock sway bar link hole as shown.
- E. Mark the upper hole on the Shock Mount Bracket to be drilled.
- F. Remove Shock Mount Bracket and drill marked hole with a 7/16” Drill. The frame is made from a very hard steel, and we recommend drilling a 1/4” (or similar) pilot hole.
- G. Install the 3/8”-16 Flange Hex Head Screws and Nuts using a 9/16” Socket and Wrench.
- H. Reinstall the stock sway bar link bolt. Fully tighten all hardware.

Important Note: Depending on your suspension setup, you may need to leave the sway bar links disconnected until after the shock installation.

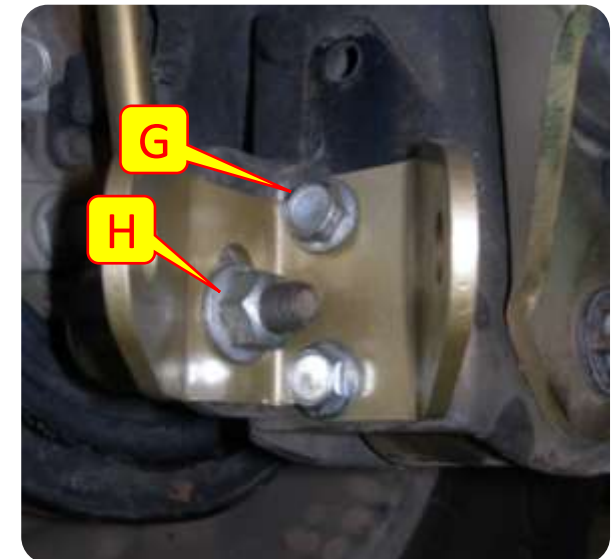
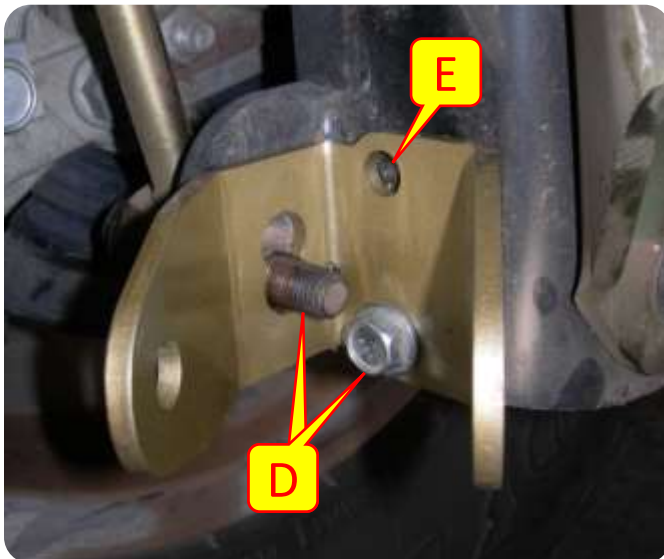

Section 3: REAR SUSPENSION Installation Instructions



Step 9: Install RockSport Shocks

- D. Install the upper rear RockSport shocks into the stock shock location. Using a 16MM socket tighten the upper shock stock hardware to torque specs (*37ft. Lbs*).



Section 4: Rear Shock Installation Instructions

Step 9: Install Shock

- K. Use the provided 1/2"-13 x 2.5" Hex Head Screw, Washer, Hex Flange Nut and Spacers to install the lower Rod End (*bushing side*) in the Shock Mount Bracket. The Washer goes under the head of the Screw, and the Flange Nut goes directly against the bracket.

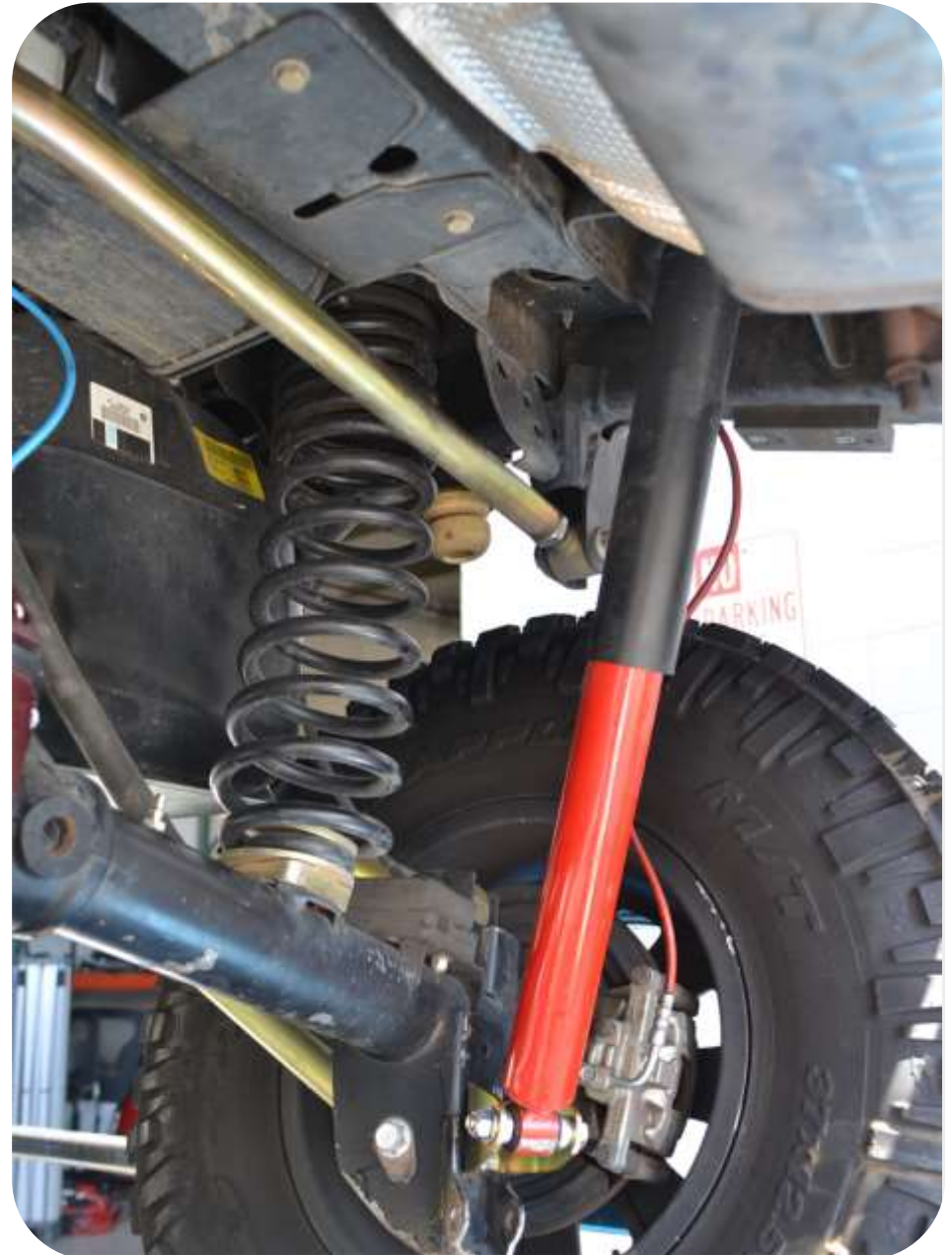

Section 3: Installation Instructions

Step 10: Install Rear Bump Stops

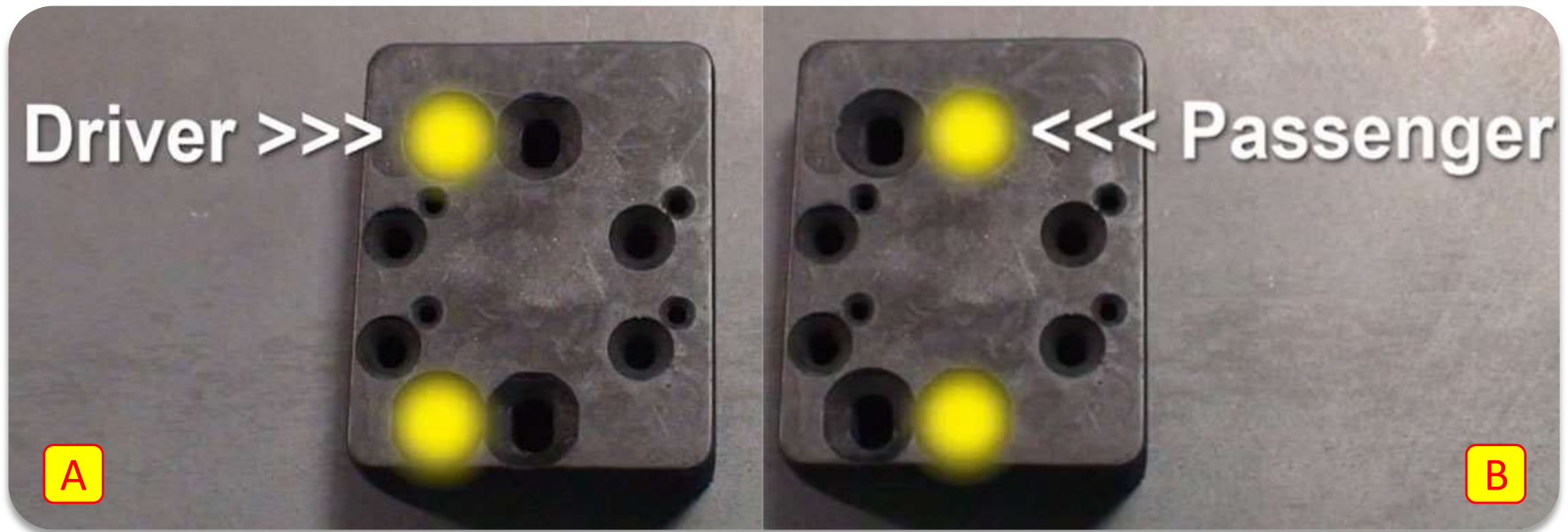

- A. Driver Side Bump Stop Holes.
- B. Passenger Side Bump Stop Holes.
- C. Diagram showing the two sides of the Bump Stops.

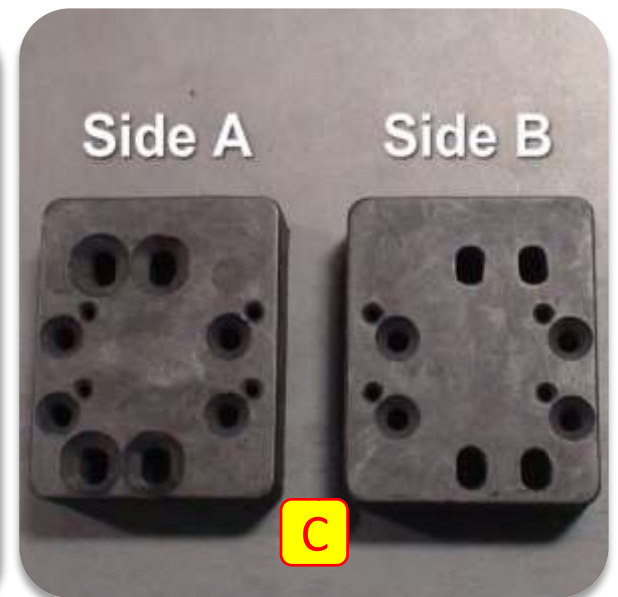

Section 3: Installation Instructions

Step 10: Install Rear Bump Stops

D. Install first bump stop puck (Side A) using the correct holes (shown in step A and B) using the 5/16 bolt with the matching nut and washer.

E. Install next puck (Side B) using the 1 3/4" woodscrews.

F. Continue until desired bump stop height (Side A/Side B/ Side A/Side B).



Step 11: Bleed Brake Lines

Important Note: *Before driving bleed brake lines.*



Section 3: REAR SUSPENSION Installation Instructions



Step 12: Rear Pinion Angle Adjustment *(if required)*

- A. The Control Arm lengths given are recommended as starting points **ONLY**. Your vehicle will tell you if the pinion needs to be adjusted. When you drive the Jeep for the first time after installing the lift or after installing a new drive shaft, if you notice rear drive line vibrations, pay attention to when the vibrations occur.
- B. If you notice vibrations during acceleration this would indicate that your pinion is too high. You can correct this condition by adjusting your rear upper control arms to a shorter length or by increasing the length of your rear lower control arms.
- C. If you notice Vibrations during Deceleration this would indicate that your pinion is too low. You can correct this condition by increasing the length of your rear upper control arms, or by adjusting the rear lower arms to a shorter length.