



PRODUCT: JT Four Link Long Arm, 6Pak Edition

REV: B | 04-04-2024 | II-A3635/A3645

**READ INSTRUCTIONS IN FULL BEFORE INSTALLATION.
QUESTIONS? CALL 916-631-8071 M-F 7:00 AM – 5:00 PM PST**

The MetalCloak experience includes the ease of installation of our products. We design for most contingencies, but installation may be different based on different Jeep condition, configuration and/or year.

We are continually trying to improve our products and instructions – please help us by providing feedback and pictures if you find any part of the instructions that do not match your particular Jeep or are not easily understandable.

If you have any difficulties at all, please give us a call. Thank you and enjoy your MetalCloak Products!

WARRANTY INFORMATION: This article is sold without warranty expressed or implied. No warranty or representation is made as to this products ability to protect the user from injury or death. The user assumes that risk. The effectiveness, warranty and longevity of this equipment are directly related to the manner in which it is INSTALLED, USED and/or MAINTAINED. THE USER ASSUMES ALL RISK. By purchasing this product and opening the packaging, purchasers expressly acknowledge, understand and agree that they take, select and purchase these MetalCloak products from Armored Works, LLC, its affiliates and distributors and agents as is and with all faults. The entire risk as to the quality and performance of these MetalCloak products is with the purchaser. Working on your vehicle can be a dangerous activity. If you are unsure of what you are doing, please leave mechanical or safety critical work to a skilled mechanic. We take no responsibility for the incorrect use and/or installation of MetalCloak products.

Section 1: Tools & Notes on Installation



Tools Required: This list is the recommended tools for ease of installation. Other versions of the same tool can be used. For example, Allen Wrenches instead of Allen Drive Sockets. Be sure to use metric on metric and SAE on SAE.



Socket & Ratchet Wrench
10" Socket Extension

7MM, 10MM, 13MM Sockets
18MM, 21MM, 24MM Sockets
9/16" , 13/16" , 15/16" Sockets
3/4", 1 1/8" Socket



Metal Head Hammer

Metric Hex Sockets
and/or Hex (Allen) Wrenches



Tape Measure

3/8" Flare Nut Wrench (10mm will
work) for Brake Lines



Cut-Off Disc and Grinder

Drill
Drill Bits (1/8" up to 1/2")
Center Punch



HOW TO USE THIS GUIDE: The installation guide contains ALL steps for installation. Please read and follow the instructions in order of each page top to bottom, and left to right.

Jeep Model: Instructions may apply to multiple Jeep models, but are labeled separately where appropriate (i.e. TJ vs. LJ).

Options: Because of the number of component options we offer, these instructions may contain steps that will not match your particular configuration. You can skip these steps.

Images: Pictures are provided and parts are labeled throughout the instructions. Each text box contains guidance based on the pictures next to it. The text will refer to alphabetical labels (A, B, etc.) found in the images.

Installation Notes: Terms may be used in the body of the instructions that you may not be familiar with, if you have any questions feel free to contact us at the number below, or email techhelp@metalcloak.com

QUESTIONS: Any questions or comments about the instructions? Call us at 916-631-8071 M-F 7:00 AM – 5:00 PM PST.

Section 2: Product Components





DC-0001 Rev B

SHEET 1 OF 1

	1	2	3	4	5	6	7	8
	ITEM	PART NUMBER/DESCRIPTION			QTY.			
	1	1161 BRAKE LINE KIT, JT REAR 24L			1			
	2	6361 SKID PLATE SYSTEM UPGRADED CROSS-MEMBER, JLU JT			1			
E	3	7040 BUMP STOP KIT, 1.0-4.0 JK FRONT			1			
	4	7043 BUMP STOP KIT, 1.0-4.0 REAR			1			
	5	7271 SWAY BAR LINK KIT, 12.25IN JT REAR			1			
	6	7291 4-LINK LONG-ARM PAIR, UPPER FRONT JK JL JT			1			
	7	7295 LONG ARM MOUNT LOWER, FRONT JL-JT			1			
	8	7297 4-LINK LONG-ARM PAIR, LOWER FRONT JL JT			1			
	9	7298 4-LINK MOUNT UPPER, FRONT JL JT			1			
	10	7403 TRACK BAR RELOCATION BRACKET, JT REAR			1			
D	11	7644 TRACK BARS, JL FRONT+REAR			1			
	12	FA-1005 ZIP TIE DOUBLE LOCK, 8IN, UV BLACK			2			
C	<p>OPTIONS:</p> <p>1) SHOCKS:</p> <p>NO SHOCKS (A5902)</p> <p>CHOOSE YOUR OWN (A5100)</p> <p>STOCK SHOCKS (A5104)</p> <p>ROCKSPORTS (1061)</p> <p>6-PAK SHOCK JT (A5105)</p>							
	<p>2) ENGINE:</p> <p>3.6L GAS (7666-G)</p> <p>DIESEL (7666-D)</p>							
	<p>3) RUBICON SWAYBAR LINKS (7015)</p> <p>NON-RUBICON QD-LINKS (7614)</p>							
B	<p>4) REAR ARM SELECTION</p> <p>REAR BOLT ON LONG ARM (7713)</p> <p>SHORT ARM W/ CORRECTION (7262)</p>							
A								
					<p>THE INFORMATION CONTAINED ON THIS DRAWING IS THE EXCLUSIVE PROPERTY OF ARMORED WORKS, LLC. UNAUTHORIZED REPRODUCTION IS PROHIBITED.</p> <p>DO NOT SCALE DRAWING</p> <p>Metal Cloak A DIVISION OF ARMORED WORKS, LLC</p>			
					<p>PART NUMBER/DESCRIPTION</p> <p>A3635 JT GLADIATOR LONG ARM 4-LINK 3.5</p>			

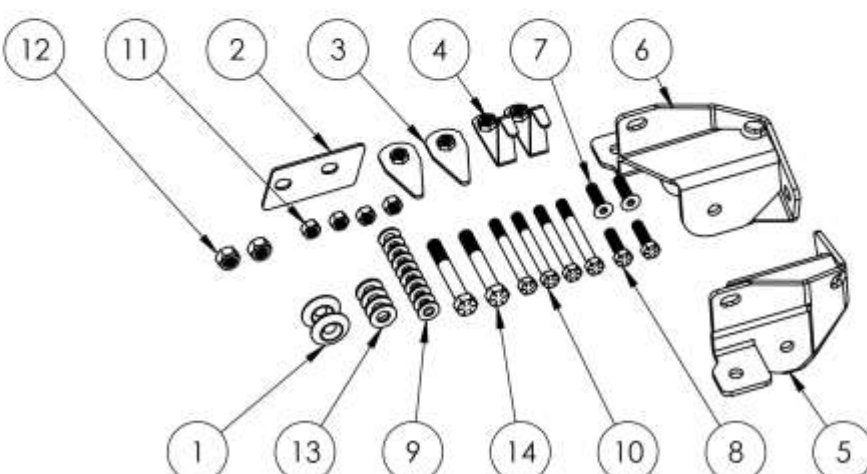
Section 2: Product Components

	1	2	3	4	5	6	7	8	
	ITEM.	PART NUMBER / DISCRIPTION					QTY.		
E	1	CP-3084 BEVELLED SKID WASHER					2		
	2	SS-0325 BACKING PLATE, LONG-ARM MOUNT LOWER, FRONT JL JT					1		
	3	WM-5897 WELDMENT, FLAG NUT .5-13, LOWER LONG-ARM MOUNT JL JT					2		
	4	WM-5898 WELDMENT, FLAG NUT 5-13, LONG ARM MOUNT JL JT					2		
	5	WM-5954 WELDMENT, LONG-ARM MOUNT LOWER, FRONT JL JT					1		
	6	WM-5954-P WELDMENT, LONG-ARM MOUNT LOWER, FRONT JL JT					1		
HK-7295									
D	7	FS-08081 SFHCS, 0.5-13 X 1.75L STL G8 ZINC					2		
	8	FS-08173 HHCS, 0.5-13 x 1.75L STL G8 ZINC FULL THREAD					2		
	9	FS-08307 WASHER, 0.53ID X 1.06OD X 0.20TH STL GR8 GOLD ZINC					10		
	10	FS-08322 HHCS, 0.50-13 x 4.50L STL G8 GOLD ZINC					4		
	11	FS-08359 TOPLOCK NUT, 0.5-13 X .44H STL GC STL ZINC					4		
	12	FS-10130 TOPLOCK NUT, 0.63-18 X 0.55H STL GC CAD					2		
	13	FS-10161 WASHER, 0.66ID X 1.31OD X 0.14TH STL GR8 GOLD ZINC					4		
	14	FS-10295 HHCS, 0.63-18 X 4.25L STL G8 ZINC					2		
C									
	B								
A						THE INFORMATION CONTAINED ON THIS DRAWING IS THE EXCLUSIVE PROPERTY OF ARMORED WORKS, LLC. UNAUTHORIZED REPRODUCTION IS PROHIBITED. DO NOT SCALE DRAWING		 A DIVISION OF ARMORED WORKS, LLC	
						PART NUMBER/DESCRIPTION 7295 LONG ARM MOUNT LOWER, FRONT JL-JT			

Section 2: Product Components

ITEM.	PART NUMBER	QTY.
1	CP-3084 BEVELLED SKID WASHER	4
2	WM-5885 WELDMENT, .5-13 FLAG NUT	4
3	WM-5896 WELDMENT, FLAG NUT .5-20, 4-LINK MOUNT JK JL	2
4	WM-5898 WELDMENT, FLAG NUT 5-13, LONG ARM MOUNT JL JT	2
5	WM-5899 WELDMENT, FRONT NUT PLATE, 4-LINK MOUNT JL JT	2
6	WM-5955 WELDMENT, 4-LINK MOUNT UPPER, FRONT JL JT	1
7	WM-5955-P WELDMENT, 4-LINK MOUNT UPPER, FRONT JL JT	1
HK-7298		
8	FS-08081 SFHCS, 0.5-13 X 1.75L STL G8 ZINC	4
9	FS-08173 HHCS, 0.5-13 x 1.75L STL G8 ZINC FULL THREAD	2
10	FS-08307 WASHER, 0.53ID X 1.06OD X 0.20TH STL GR8 GOLD ZINC	4
11	FS-08311 HHCS, 0.5-20 x 3.00L STL G8 ZINC	2
12	FS-12319 WASHER, 0.81ID X 1.49OD X 0.12TH STL GR8 GOLD ZINC	4
13	FS-12352 HHCS, 0.75-10 X 1.75L STL G8 GOLD ZINC	4

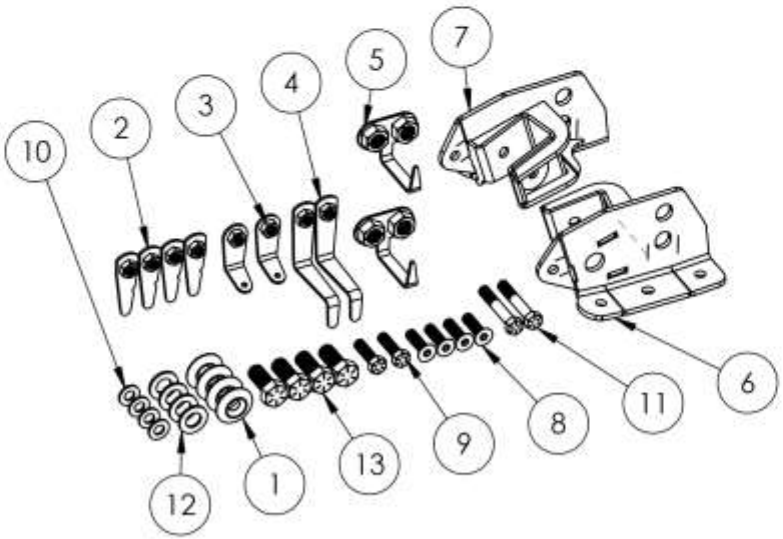

THE INFORMATION CONTAINED ON THIS DRAWING IS THE EXCLUSIVE PROPERTY OF ARMORED WORKS, LLC. UNAUTHORIZED REPRODUCTION IS PROHIBITED.

DO NOT SCALE DRAWING

PART NUMBER/DESCRIPTION



A DIVISION OF ARMORED WORKS, LLC

7298 4-LINK MOUNT UPPER, FRONT JL JT

Section 2: Product Components



DC-0001 Rev B

SHEET 1 OF 1

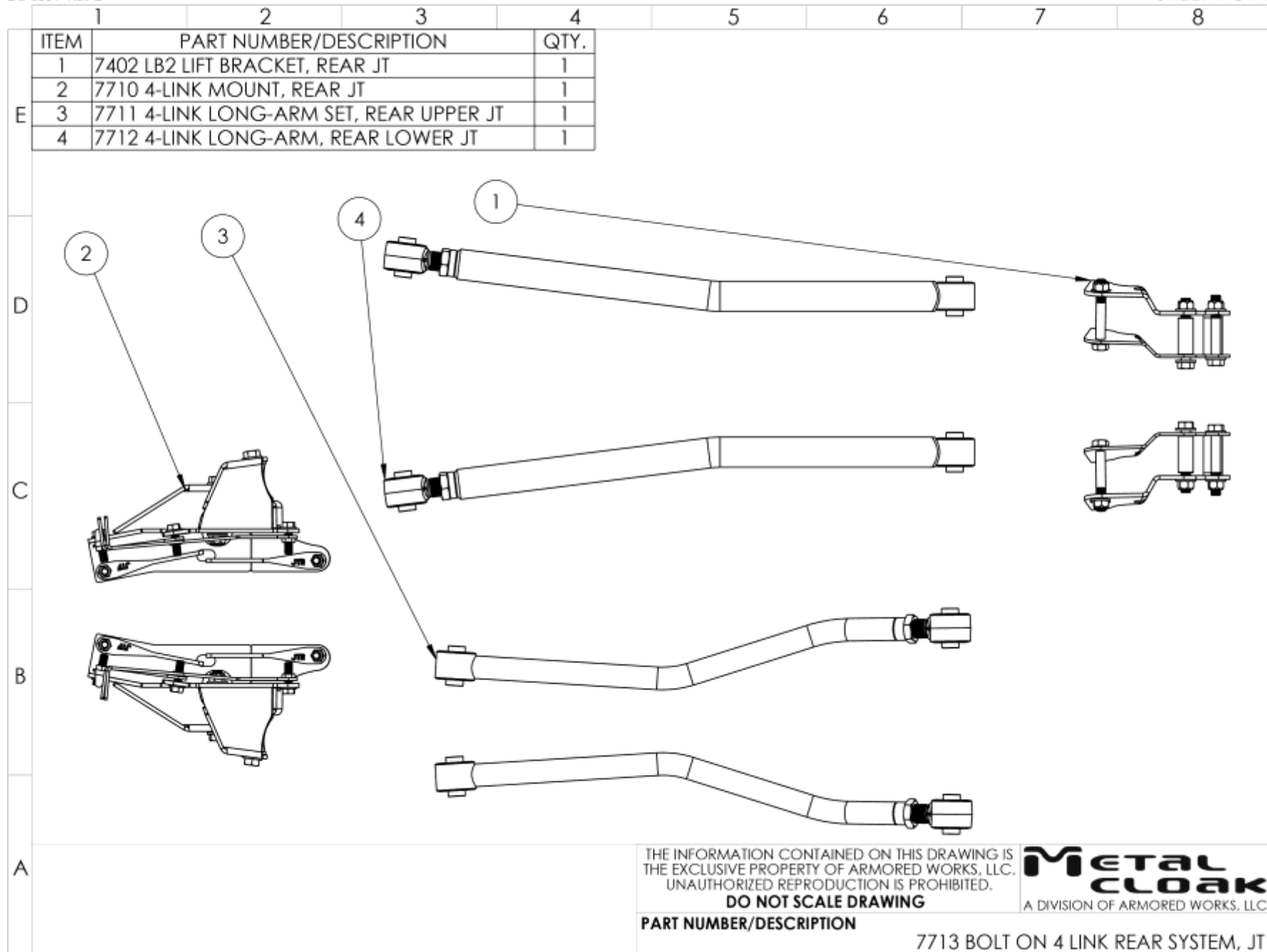

Section 3: Installation Instructions

Important Note: MetalCloak recommends replacing the factory drive shaft. The factory drive shaft binds at transfer case side and the factory drive shaft is too short for additional travel. An aftermarket drive shaft clears t-case and is optimal for maximum travel

Factory Drive Shaft T-Case Bind

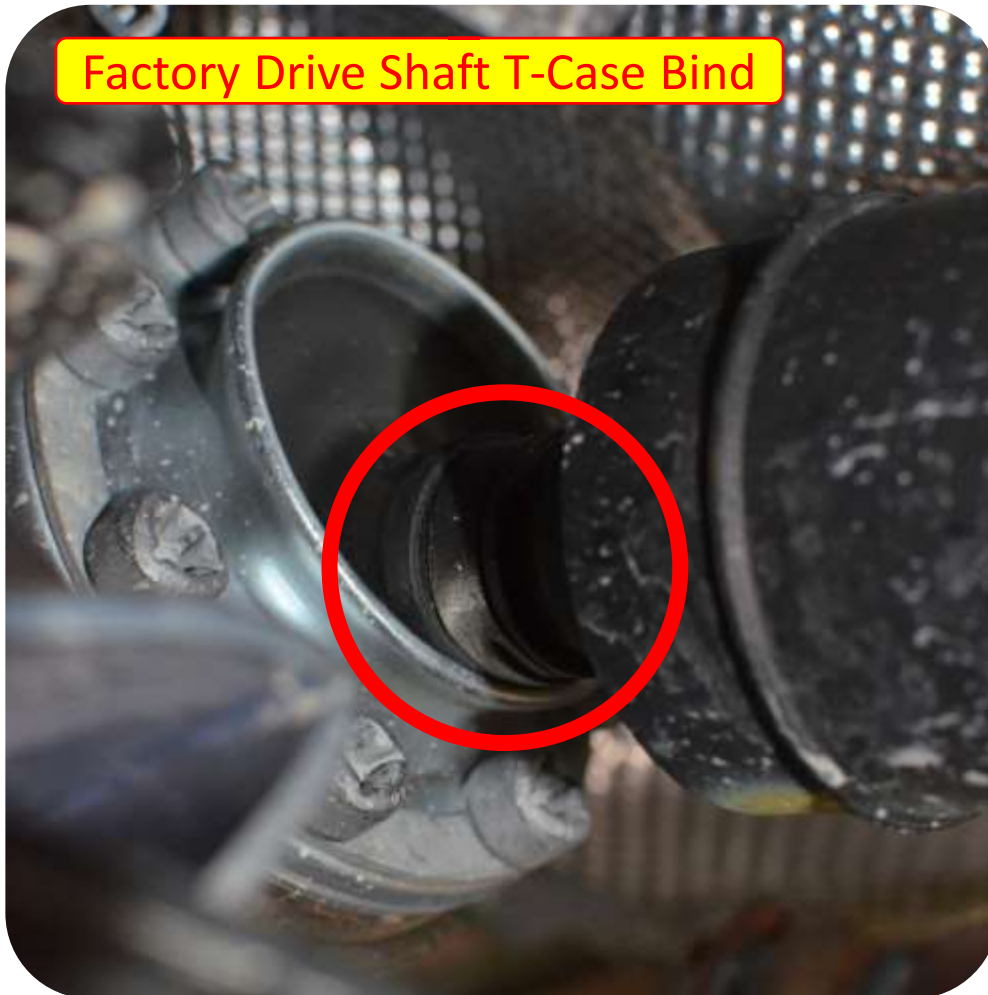

Factory Drive Shaft Misalignment



Full Droop

Aftermarket Drive Shaft Correction



Full Droop

Section 3: Installation Instructions



Important Note: *MetalCloak does not recommend powder coating your True Dual Rate Coils. The baking process in powder coating can, in some cases, cause the metallurgical properties of the coils to be changed, resulting in the loss of the lift properties of the coils. As such, the process of powder coating the coils will void any warranty stated or implied in relation to the coils.*

Important Note: *To install lift components, you will need to fully 'droop' your suspension in the front and rear (not at the same time). We strongly recommend that the vehicle be placed on an automotive lift and that all appropriate safety precautions be taken to secure the vehicle while it is off the ground. Always use the necessary axle stands (or equivalent) to support the axle when the suspension components are disconnected for safety, and to ensure the integrity of your suspension system during the installation process.*

Section 3: Installation Instructions



Step 1: Remove Stock Components

- A. Disconnect front sway bar links using a 18MM wrench and 6MM Allen Wrench. **Save all Hardware**
- B. Using a 10MM Socket disconnect the brake line brackets that is attached to the frame. **Save all Hardware.**

Important Note: The brake line on the lower front control arms (drivers and passenger side) must be removed from the bracket. It may be pried out or cut; be VERY careful not to damage the brake line!!!

Important Note: To help prevent strain on the brake lines MetalCloak recommends clipping all zip ties attached to the brake lines.

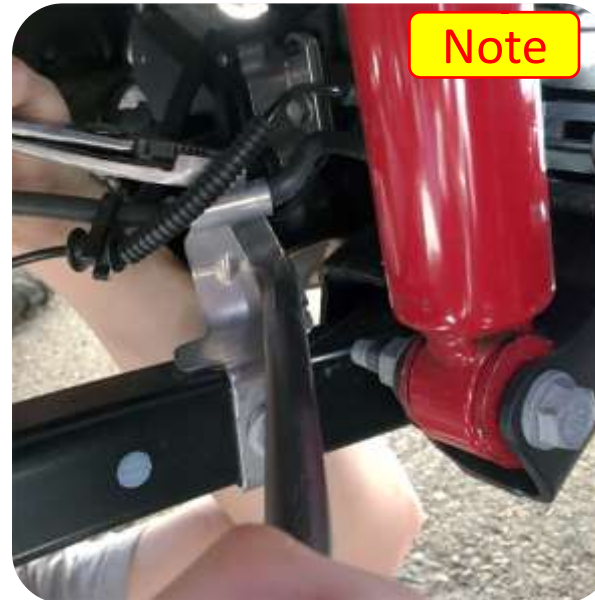
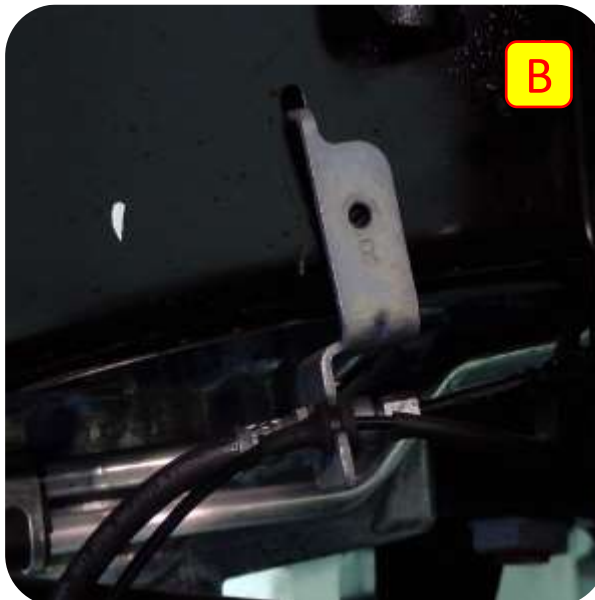
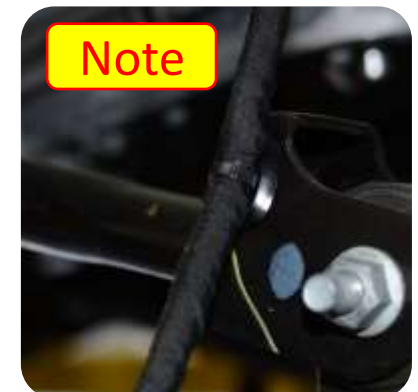

Section 3: Installation Instructions

Step 1: Remove Stock Components

Important Note: Disconnect any electronics attached to the axle (Locker plug, Front axle disconnect plug, etc.)

- C. Using a 21MM Socket disconnect the stock track bar. Save all hardware.
- D. Use a 18MM Socket and Wrench to remove the shocks. Save all hardware
- E. Remove stock springs, and any spacers that have been used if vehicle has been previously lifted.

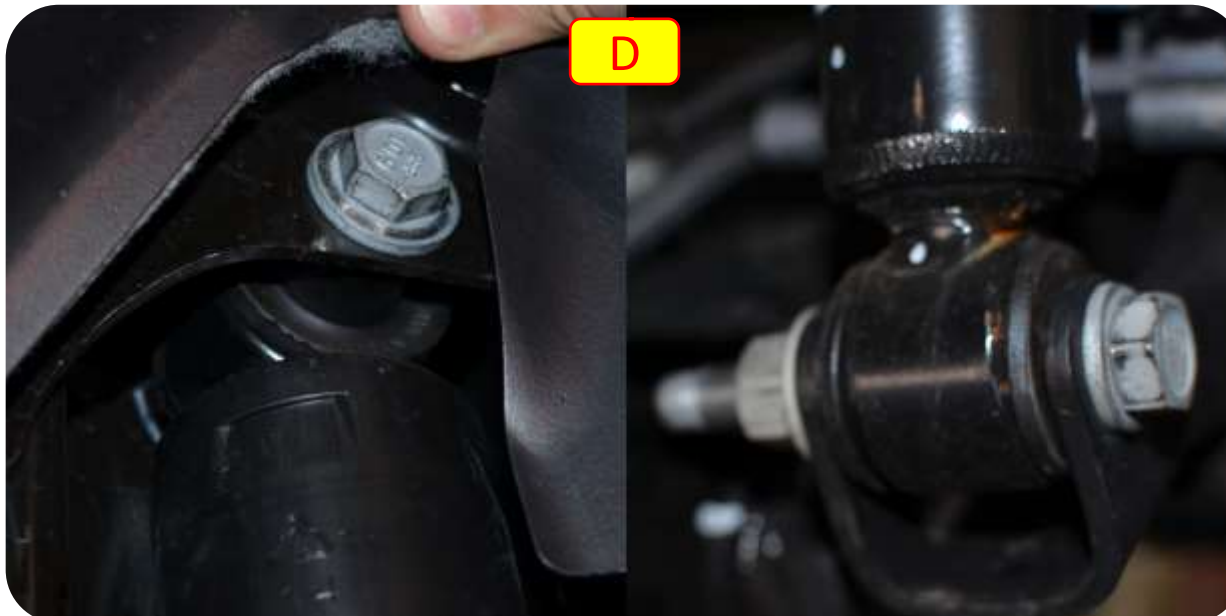

Section 3: Installation Instructions



Step 2: Install MetalCloak Crossmember

Note: Before removing the crossmember support the transmission and transfer case with jackstands.

- A. Remove the factory cross member and install the provided MetalCloak cross member using 21mm socket at the transmission mount, a 13mm socket for the exhaust mount and 18mm socket and wrench for the crossmember.



Section 3: Installation Instructions

Step 3: Disconnect Front Control Arms (*Stock Control Arms*)

Note: Make sure to use jack stands to support the axle before removing the control arms.

Note: The brake line on the lower front control arms (drivers and passenger side) must be removed from the bracket. It may be pried out or cut; be VERY careful not to damage the brake line!!!

Note: On the passenger side upper control arm you will need to cut the stock bolt as the exhaust interferes with the bolt removal.

- B. Disconnect the upper control arm heat shield on both sides at the frame using a 10MM Socket. Save heat shields and all hardware.
- C. Use a 24mm Socket & Wrench to remove the stock bolts from the front lower control arms. **Save all hardware.**
- D. Using a 18mm wrench and socket remove the Front Upper Control Arms. **Save all hardware.**

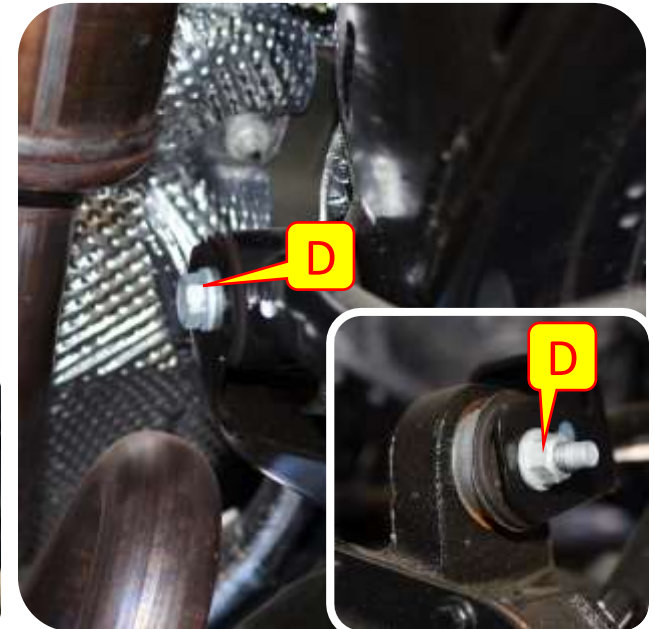
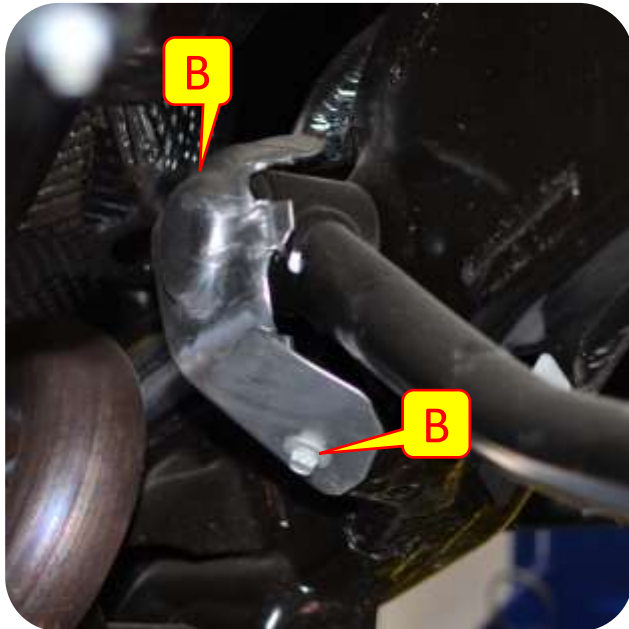

Section 3: Installation Instructions



Step 3: Disconnect Front Control Arms (*MetalCloak Mid Arms*)

Note: Make sure to use jack stands to support the axle before removing the control arms.

- E. Disconnect the front lower control arms using a 24mm socket & wrench. **Save Hardware.**
- F. Disconnect the front upper control arms using a 18mm socket and wrench. **Save Hardware.**

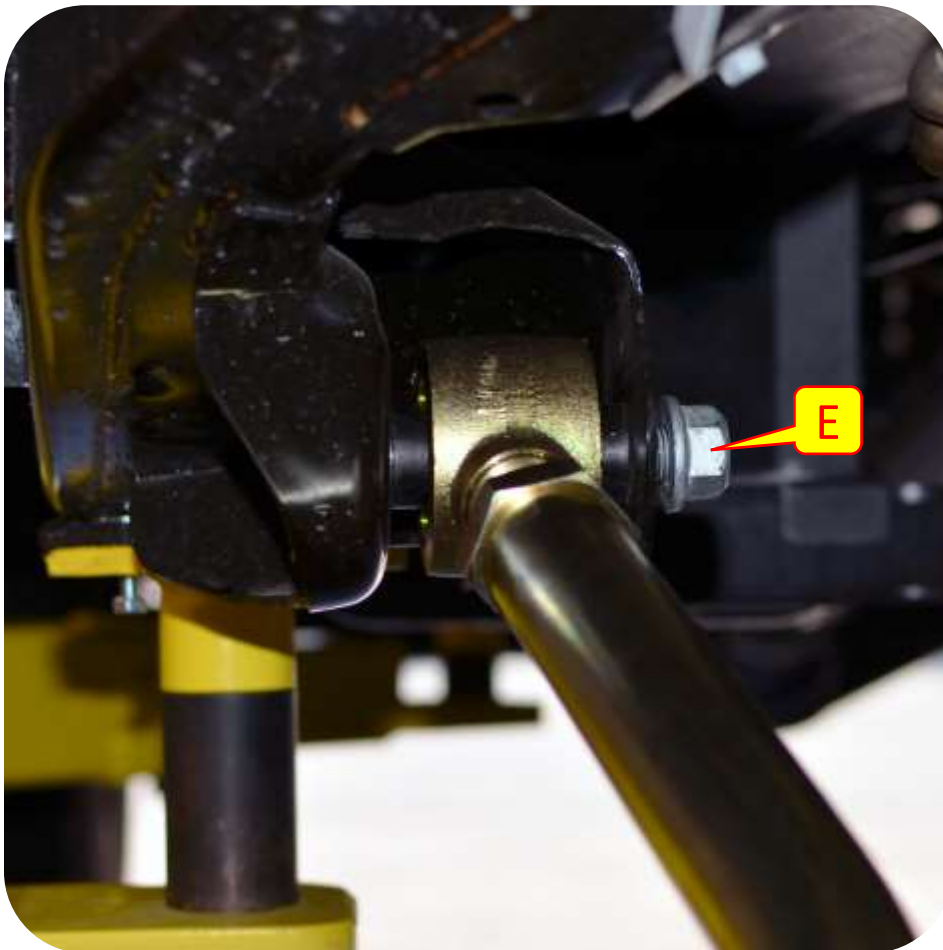

Section 3: Installation Instructions

Step 4: Removing Stock Control Arm Mounts

Note: You can unbolt and remove driver and passenger catalytic converters from the vehicle. This will allow more room for removal of factory bracketry and later installation of upper control arms bolts. **This step is optional and is not required.**

- G. Using a cut off wheel & grinder or torch remove the factory front control arm brackets from the frame.
- H. Clean and paint any exposed metal to prevent rust.

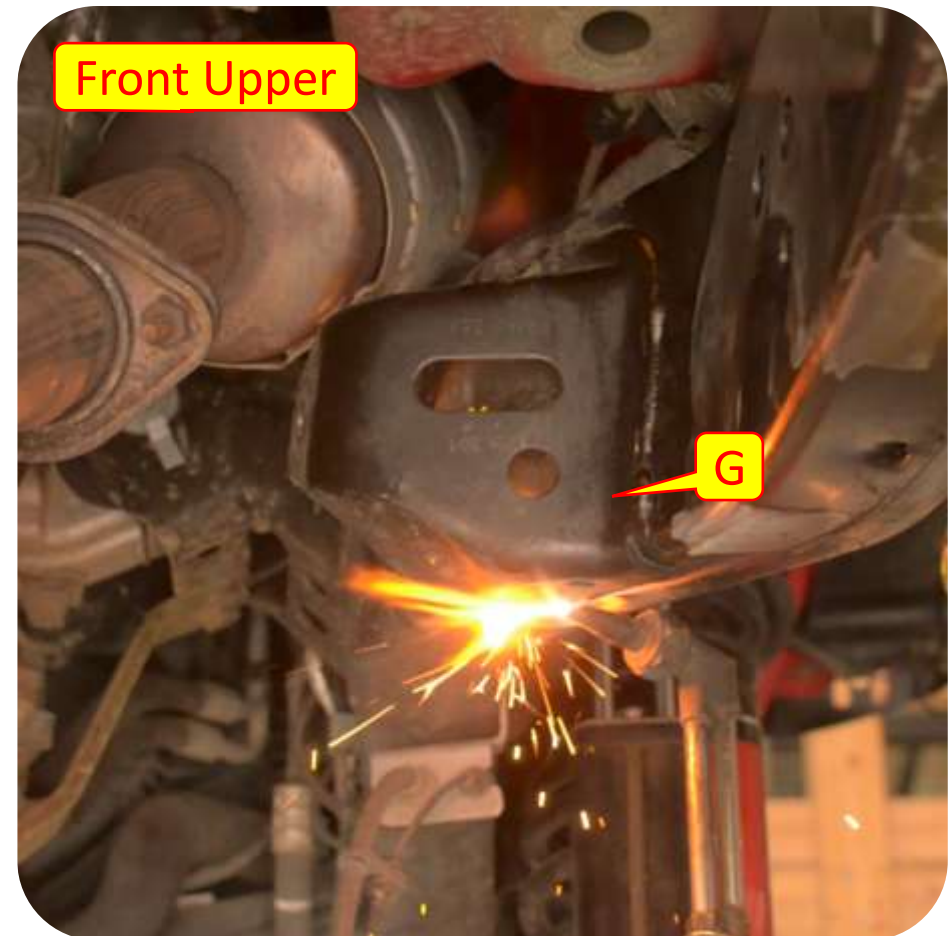
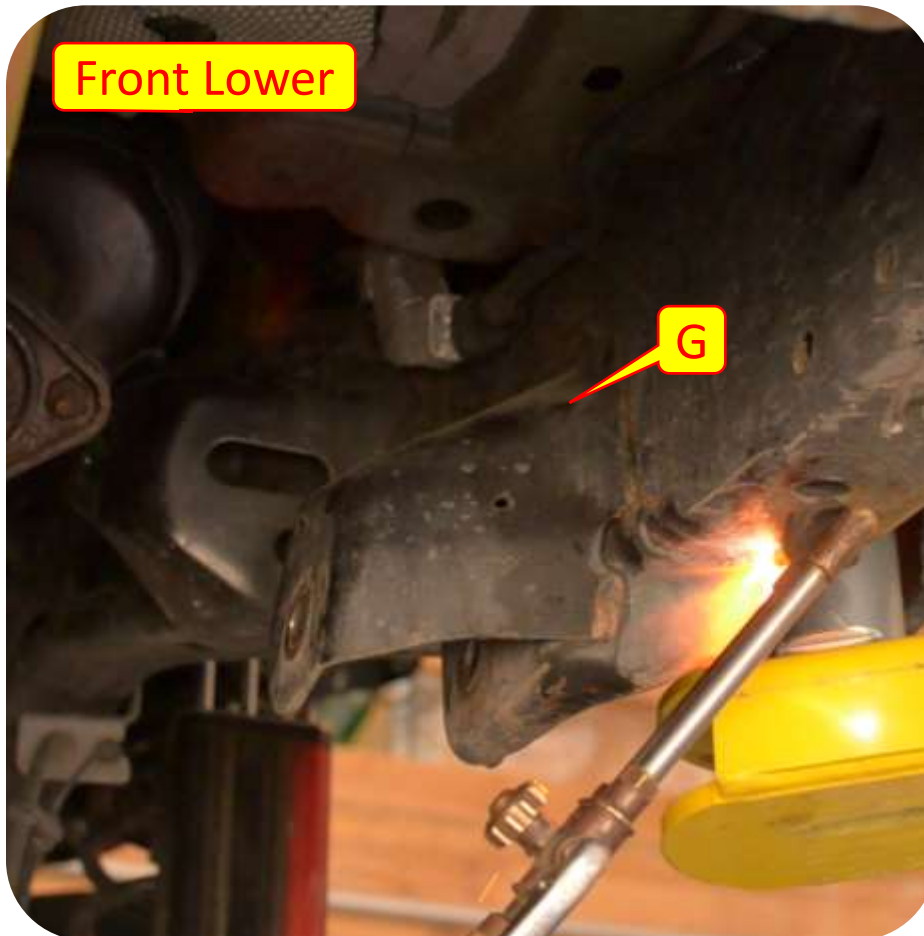

Section 3: Installation Instructions

Step 5: Install the Front Lower Control Arm Bracket

- I. Install the lower control arm bracket to the crossmember using the provided 1/2" bolts (3/4" head), washers and nuts and hand tighten.

Note: *The passenger side lower control arm bracket comes with a shim to be placed between the bracket and the crossmember.*

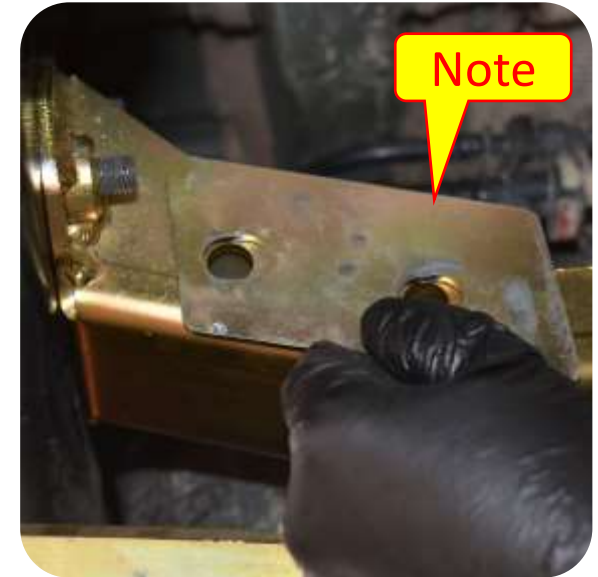

Section 3: Installation Instructions

Step 5: Install the Front Lower Control Arm Bracket

J. Insert flag nut (*BOM#3*) into the frame and install the 3/4" head bolt and washer through the control arm bracket at the bottom of the frame.

K. Insert flag nut (*BOM#4*) into the side of the frame and install 3/4" bolt through control arm bracket and frame.

L. Tighten all lower control arm bracket hardware.

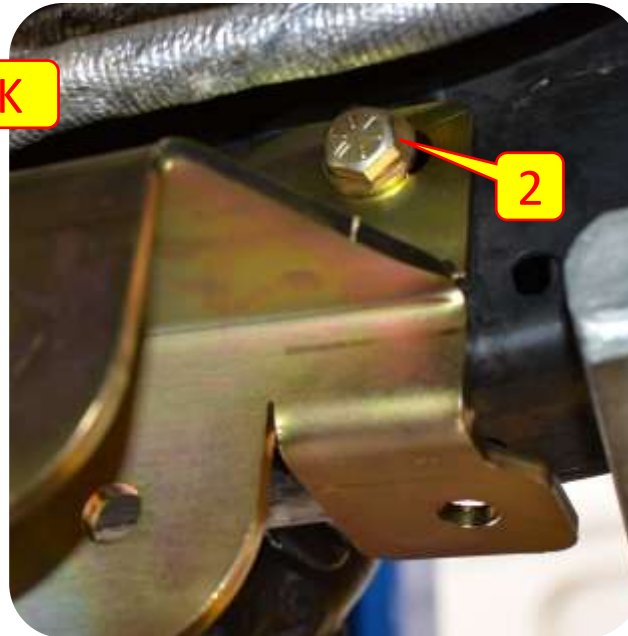
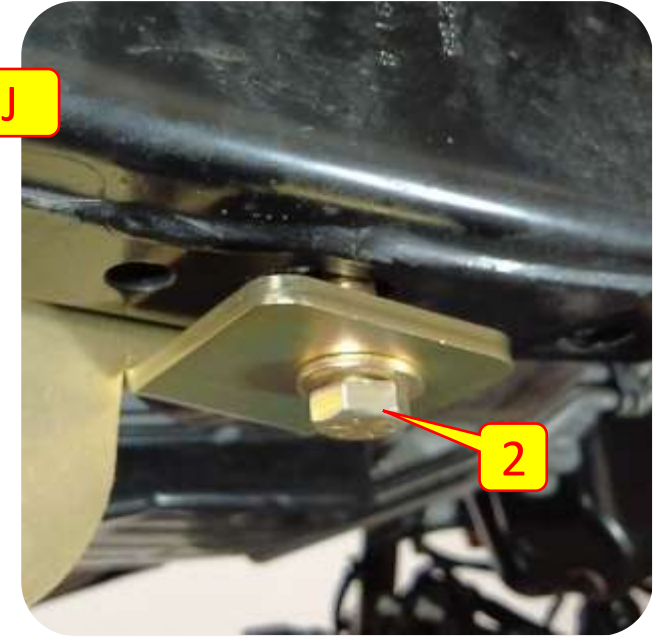
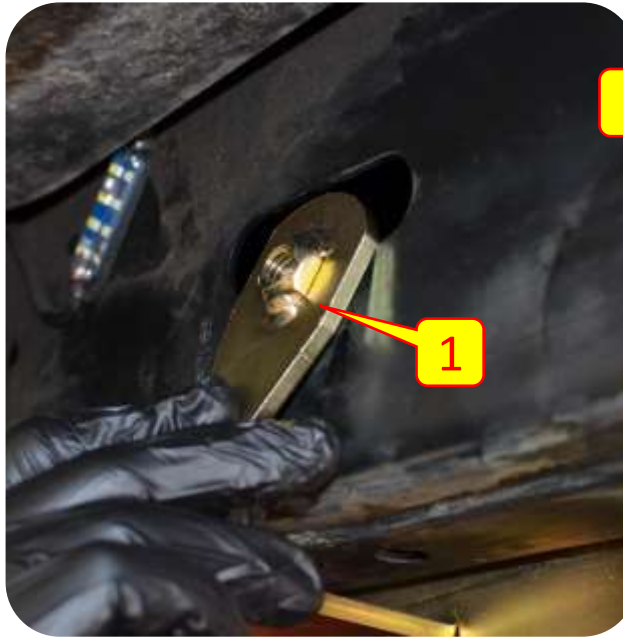

Section 3: Installation Instructions

Step 6: Install the Front Upper Control Arm Bracket

- M. Place upper control are bracket up to frame and align rear most slot on the bottom of the bracket with factory threaded insert using the provided 18mm head 12mm bolt.
- N. Insert the double flag nut into the hole in the side of the frame and install the provided 1 1/8" bolts into weld nuts (*BOM#5*) and tighten.

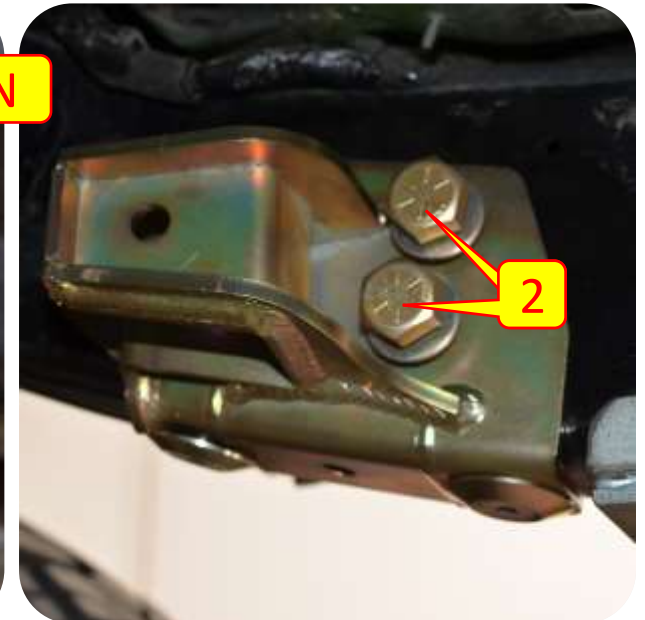

Section 3: Installation Instructions

Step 6: Install the Front Upper Control Arm Bracket

- O. Using a 1/2" drill, drill out the remaining hole on the inside of the bracket. and drill out the front and back hole on the bottom of the bracket, **do not drill out the center hole on the bottom.**

- P. Insert the flag nut (*BOM#4*) into the hole in the side of the frame and install the provided 1/2" bolt (*3/4" head*).

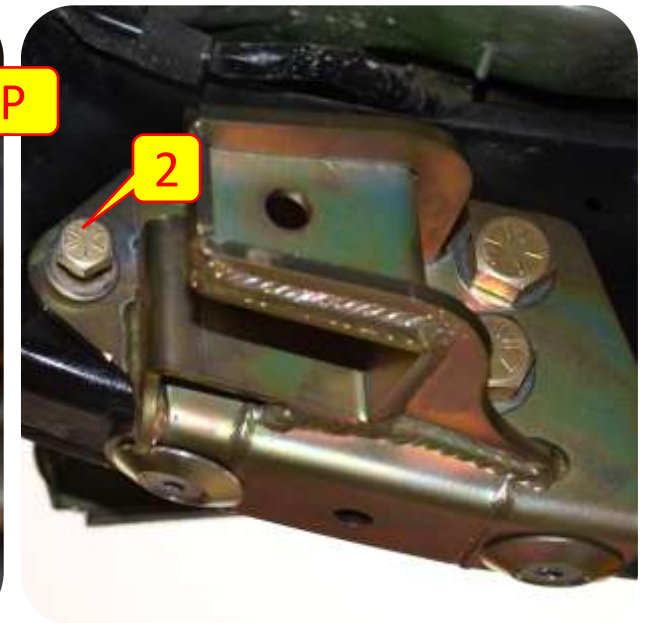
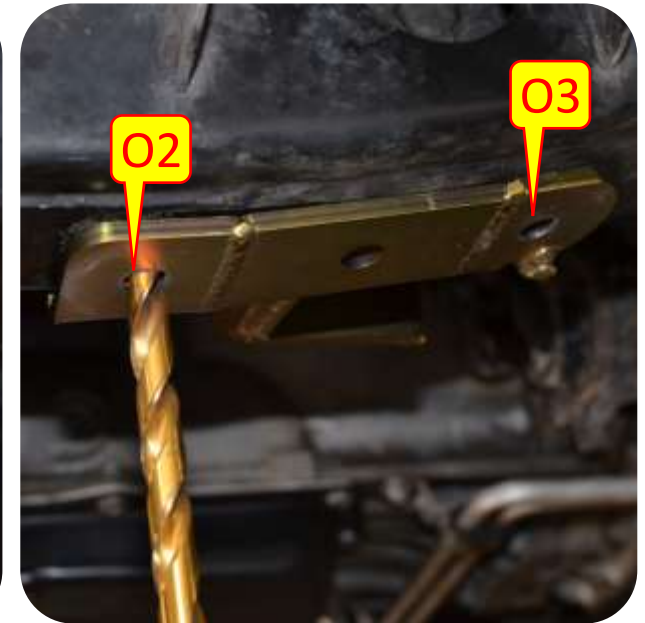

Section 3: Installation Instructions

Step 6: Install the Front Upper Control Arm Bracket

- Q. Insert the flag nut (*BOM#2*) into the hole in the side of the frame and install the provided skid washer and 1/2" countersunk 5/16" allen bolt (*You can use masking tape to help fish the flat flag nuts down the frame in needed*).
- R. Tighten all front upper control arm bracket hardware.

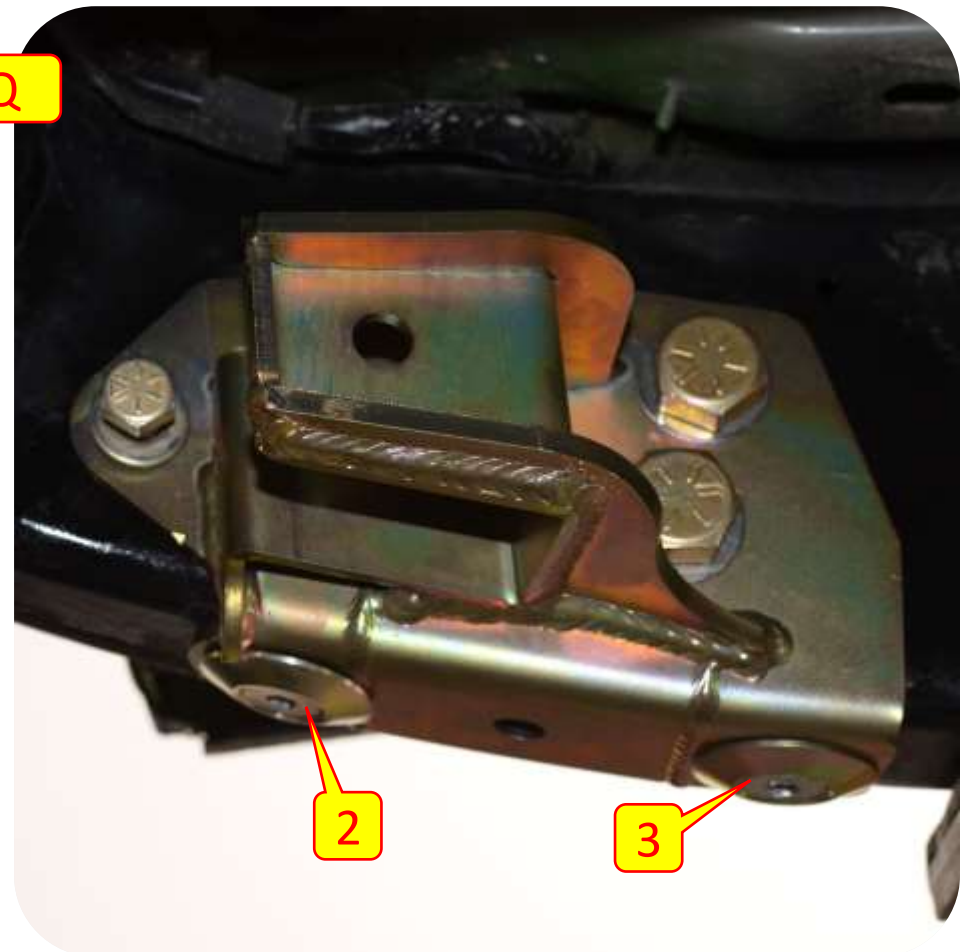

Section 3: Installation Instructions

Step 7: Install the Front Control Arms

Note: Measure the upper front control arms to 26 3/4" eye to eye and the lower rear control arms to 37 9/16" eye to eye. These control arm specifications are just starting points. **ALL JEEPS ARE DIFFERENT.** MetalCloak recommends seeing a suspension specialist for correct control arm lengths for **YOUR** Jeep.

- S. Install the front upper control arm into the upper control arm bracket loosely using the provided 1/2" bolt and flag nut (BOM#3 & BOM#11).
- T. Install the lower control arm into the axle and bracket at the crossmember using a 13/16" socket at the frame and the factory 21mm bolt at the axle.
- U. Set the caster and install the upper control arms at the axle end using the factory hardware.

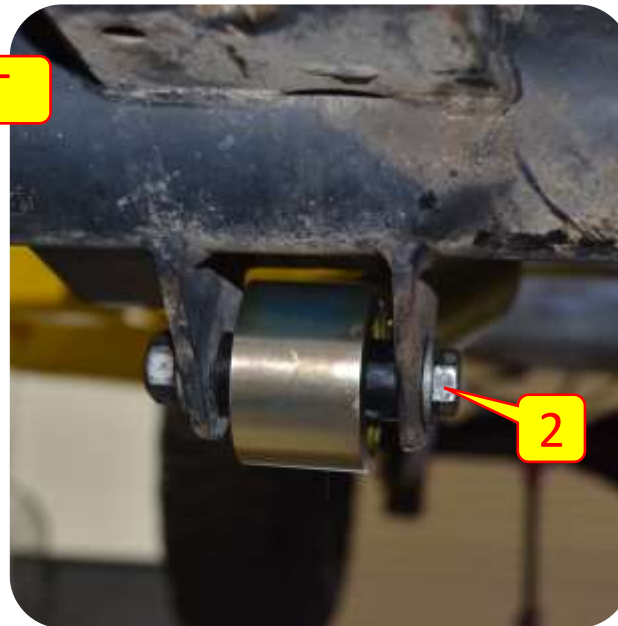
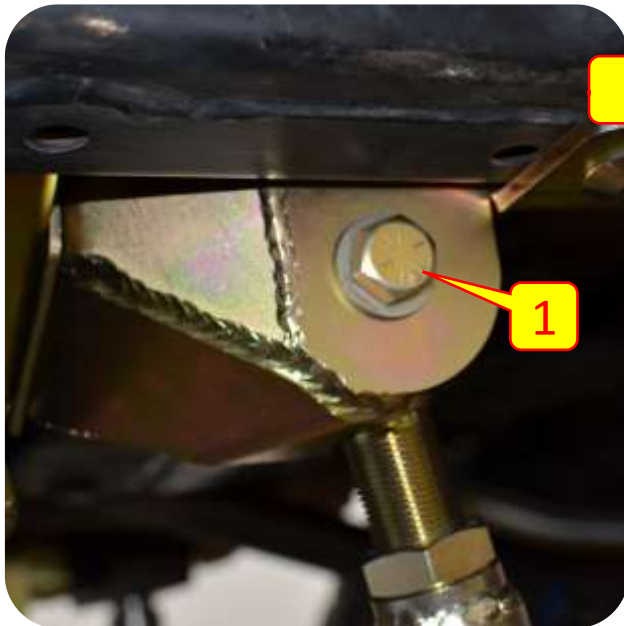



Section 3: Installation Instructions



Coil Isolator Information Guide

Important Note: MetalCloak's suspension systems include a unique coil design that utilizes upper isolators to position the coil. The following table will help you identify where to install the isolators included with your kit. You must remove the stock isolators before installing the provided coil isolators. If you have any questions give us a call at 916-631-8071.

Coil Isolator Jeep Locations		
Isolator Type	Jeep Model	Installation Locations
Tall Isolator 	JL Wrangler 3.6L Non-E Torque	Upper Front Passenger
	JL Wrangler 2.0T E-Torque	Upper Front Driver & Passenger
	JL Wrangler 4xE	Upper Front Driver & Passenger
	JL Wrangler Diesel	Upper Front Driver & Passenger
	JT Gladiator Diesel	Upper Front Driver & Passenger
Short Isolator 	JK Wrangler (All Models)	Upper Front Driver & Passenger
	JL Wrangler 3.6L Non-E Torque	Upper Front Driver
	JL Wrangler 3.6L E-Torque	Upper Front Driver & Passenger
	JL Wrangler Turbo	Upper Front Driver & Passenger
	JL Gladiator 3.6L Motor	Upper Front Driver & Passenger
Rear Isolator 	JL Wrangler 3.6L Non-E Torque	Upper Rear Passenger
	JL Wrangler 4xE	Upper Front Driver & Passenger

Section 3: Installation Instructions

Step 8: Install Coils and Bump Stops

- K. Using a 10mm socket disconnect the bracket from the spring perch on the axle.
- L. Drill out the center hole using a step bit or you can start your hole with a smaller drill bit and work your way up to a 1/2".
- M. Install the front coils. Make sure the tightly wound coils are oriented upward.
- N. Slip the bottom of the coil onto the coil base on the axle. Rotate the coil until it is seated properly on the coil base.

Important Note: Droop your suspension to gain access to the spring perch. Be sure to watch the ABS lines so they do not get over extended and break.

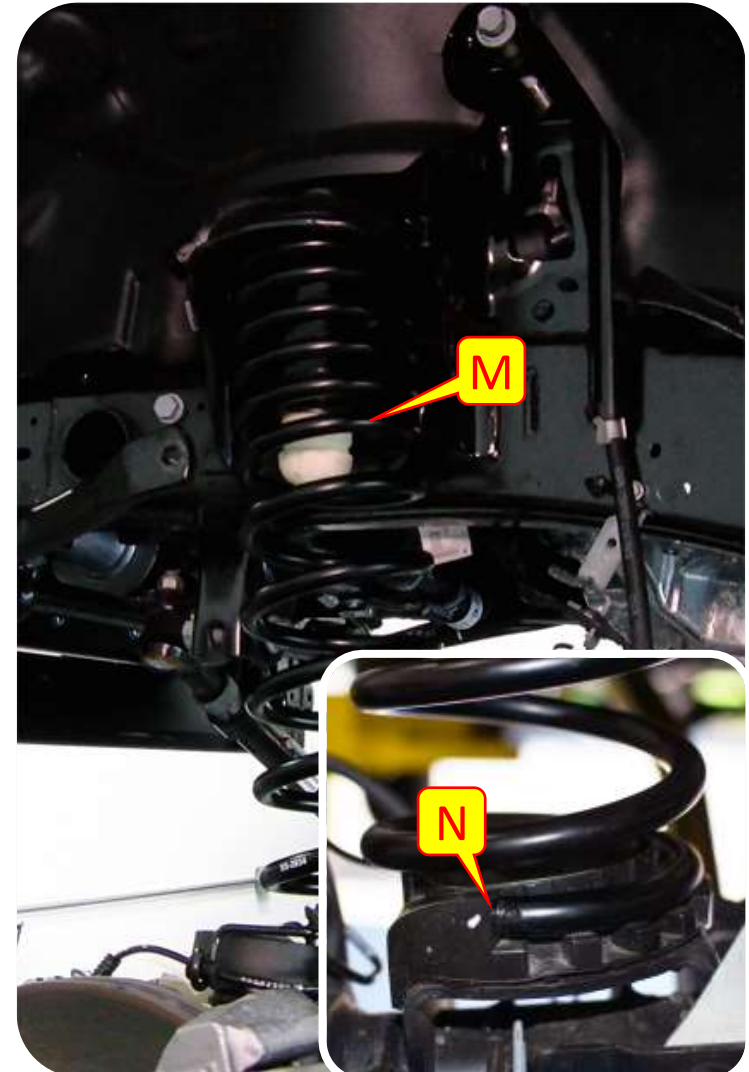

Important Note: If the axle does not droop enough to allow the coil to be put in place a coil compressor can be used to compress the coil to allow fitment.

Section 3: Installation Instructions

Step 8: Install Coils and Bump Stops

Important Note: Your individual build may require an addition or removal of bump stop pucks for your tire size fitment.

O. Select the appropriate Screw length so that the threads stick out of the bottom Disks approximately $\frac{3}{4}$ ". Assemble your bump stops inside the installed coil by feeding the $\frac{1}{2}$ " Countersunk Screw through the Cover Plate, and then threading through the Bump Stop Disks. The center hole in the Disk is intentionally small to create the most rigid assembly possible after installation.

P. The $\frac{1}{2}$ " Screw is backed by a $\frac{1}{2}$ " Flanged Nylon Lock Nut. Install the nut and tighten the hardware using a $\frac{5}{16}$ " Hex Key Socket or Allen Wrench and a $\frac{3}{4}$ " Wrench. Tighten until everything is tight; the hardware will not bottom out, but instead will begin to compress the Disks.



Section 3: Front Shock Installation Instructions

Step 9: Install 6Pak Shocks

- Q. Place the shock bracket into place aligning the top bracket hole to the factory location and install the stock bolt into the top hole of the bracket and tighten with the side hole against the coil bucket.
- R. Using a 1/2" drill bit drill out the side hole. Once the hole is drilled loosen the top shock bracket bolt.
- S. Using a 3/4 socket and wrench tighten down the side bolt.
- T. Install the bushing end (top) of the 6Pak shock and the spacer on the inboard side of the bushing end.
- U. The axle side shock mounts into the stock bracket with aluminum spacers pushing the shock outboard; big spacer on the inboard side and short spacer on the outboard side. Tighten using a 18MM Socket and wrench.

Note: The 6-Pak Shock Reservoir Tubes (RED) should point away from the vehicle, perpendicular to the frame of the JEEP

Important Note: The front driver side shock will hit the lower shock mount during articulation you must grind the shock mount before installing. (See page 13)

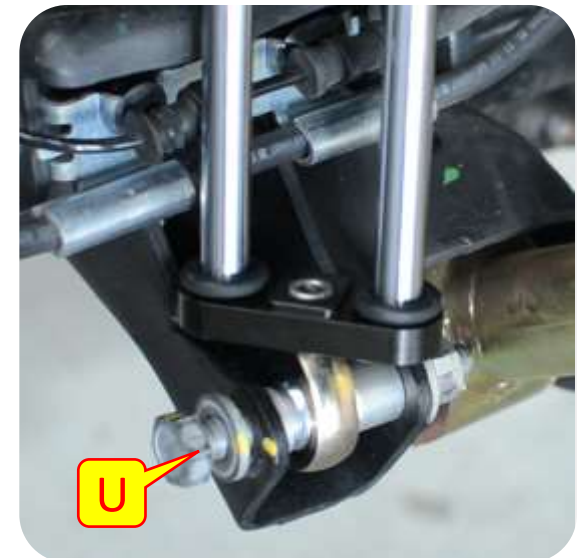
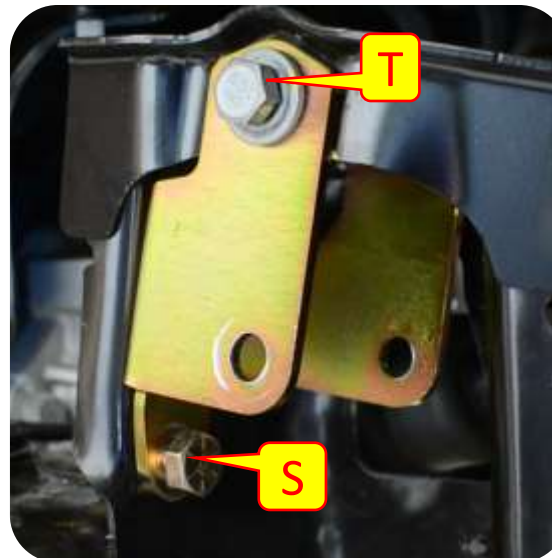
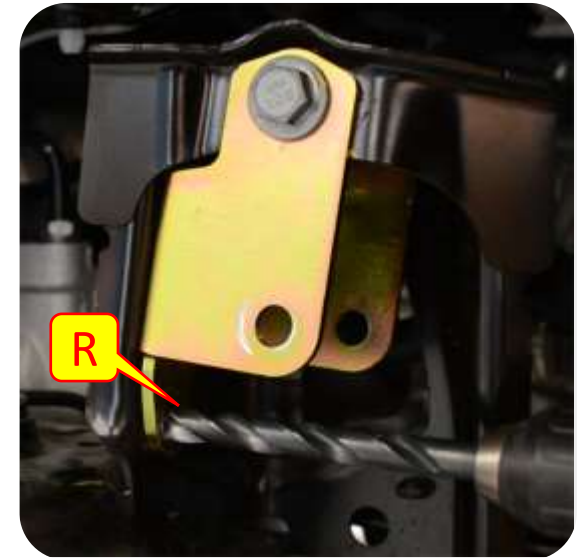

Section 3: Front Shock Installation Instructions

Step 9: Install 6Pak Shocks (Driver Side)

- V. Align the shock with the lower shock mount on the driver side and mark the area in preparation for removal.
- W. Using a cutoff wheel remove the marked area on the driver side lower shock mount.
- X. MetalCloak recommends painting all exposed metal to help prevent rust.
- Y. Install the shock into the lower shock mount. The axle side shock mounts into the stock bracket with aluminum spacers pushing the shock outboard; big spacer on the inboard side and short spacer on the outboard side. Tighten using a 18MM Socket and wrench.

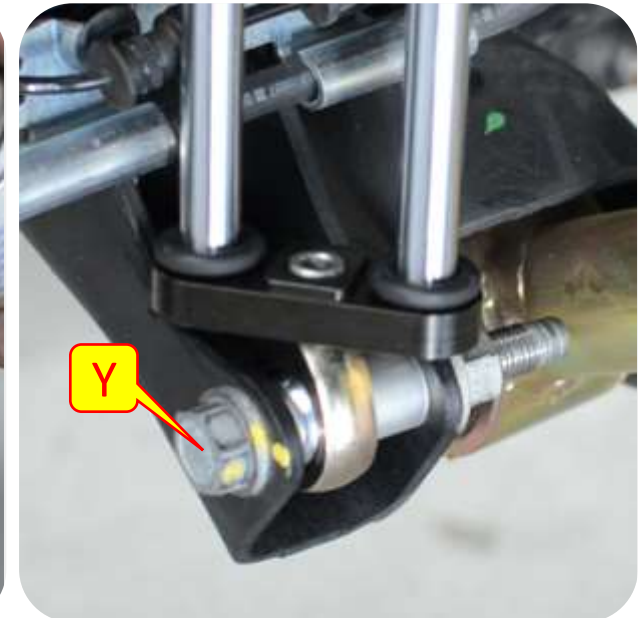

Note: The 6-Pak Shock Reservoir Tubes (RED) should point away from the vehicle, perpendicular to the frame of the JEEP

Section 3: Installation Instructions



Step 10: Install Front Track Bar

- Z. Install the front track bar. Making sure the adjustable end of the track bar goes into the stock bracket on the axle. Re use the stock hardware.
- AA. Install the fixed end of the track bar into the stock frame bracket. The clearance bends should point towards the front bumper, up and away from the differential cover. Re use the stock hardware.
- BB. Fully tighten the stock hardware on both ends of the Track Bar using a 21MM socket and wrench, and then tighten the Jam Nut on the Track Bar.
- CC. MetalCloak **STRONGLY RECOMMENDS** having your alignment checked by a professional after changing any suspension components.

Note: *It is helpful to have someone push the vehicle to the driver or passenger side to help align the hole; if you don't have an extra pair of hands you can use a ratchet strap on the frame/axle to pull the frame in the desired direction. Lower the Jeep to the ground to ensure the axle is centered once the bolt is in place. If not then remove the bolt, adjust the Track Bar length, replace the bolt, and re-check axle centeredness. Repeat until the axle is as close to center.*

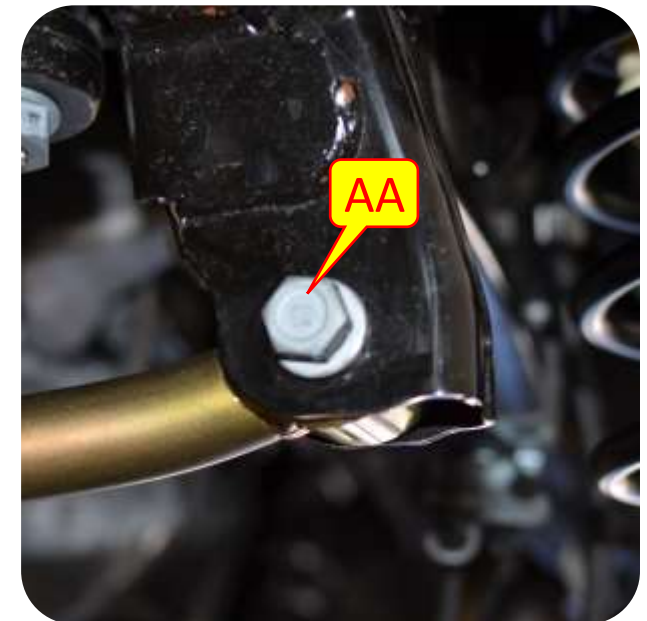

Section 3: Installation Instructions

Step 10: Install Front Track Bar

Note: MetalCloak uses an over-sized forged housing for additional strength; the factory window pocket may need additional clearance for optimal fitment. Use a die grinder and cutting bit to enlarge the existing window in the factory track bar bracket.



Section 3: Installation Instructions



Step 11: Install Sway Bar End Links

DD. Using the factory hardware install the bottom of the MetalCloak extended sway bar links.

EE. Using the supplied hardware install the top of the MetalCloak extended sway bar links

FF. Tighten sway bar end links with an 18MM Wrench for the factory hardware and a 3/4" & 18MM wrench for the supplied hardware.

Important Note: MetalCloak recommends using red Loctite on each of the upper spindles of the sway bar end links.

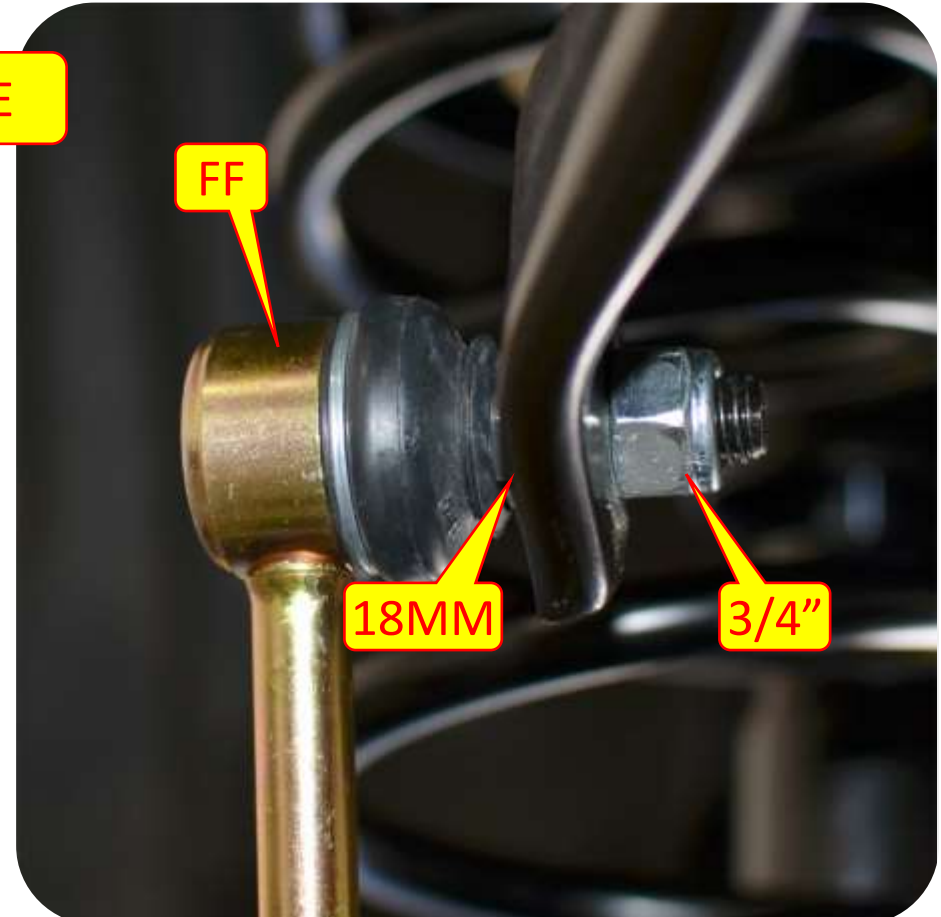
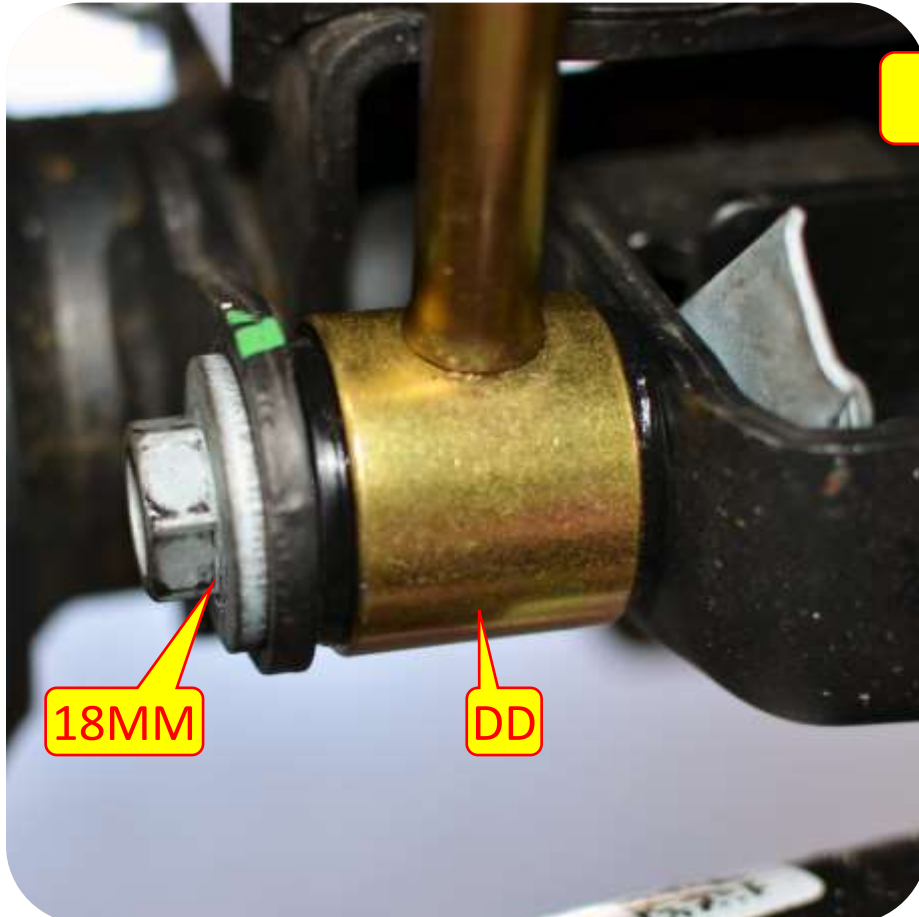

Section 3: Installation Instructions



Step 12: Finalize Installation

GG. Adjust the caster angle and toe as needed. Once set, tighten all hardware, Re attach all brackets and reinstall the heat shield. Finally, tighten the jam nuts on all control arms.

Note: When lifting any vehicle, basic dynamics are changed. It is important to take your vehicle to a professional for an alignment after installation. Make sure caster setting is adjusted for a lifted vehicle (not stock specs).

Section 3: Installation Instructions



Step 1: Remove Stock Components

Important Note: MetalCloak Recommends removing the bottom rear fender well plate for easier access to the upper shock bolts by using a 8MM socket wrench.



Section 3: Installation Instructions

Step 1: Remove Stock Components

- A. Using a 21mm socket and wrench disconnect the stock shocks. **Save all hardware.**
- B. Disconnect the locker, breath tube, and wheel speed sensor lines, and emergency brake bracket from the axle.
- C. Disconnect the rear sway bar links using an 18MM wrench. **Save all hardware.**
- D. Using a 21MM Socket and wrench disconnect the stock rear track bar. **Save all Hardware.**
- E. Remove Stock Coils.

Important Note: Make sure the axle is supported before disconnecting anything.

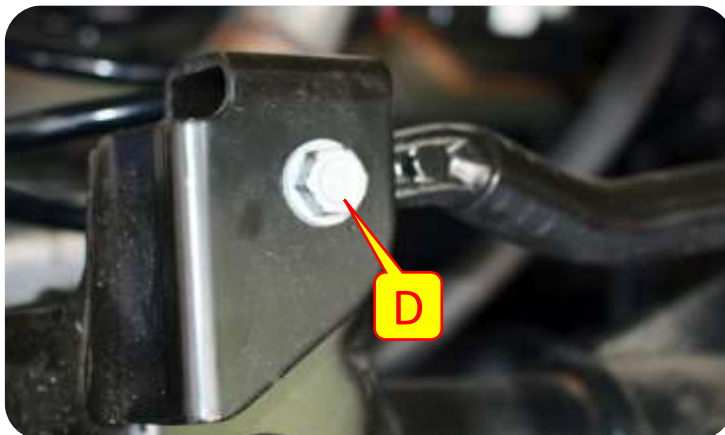
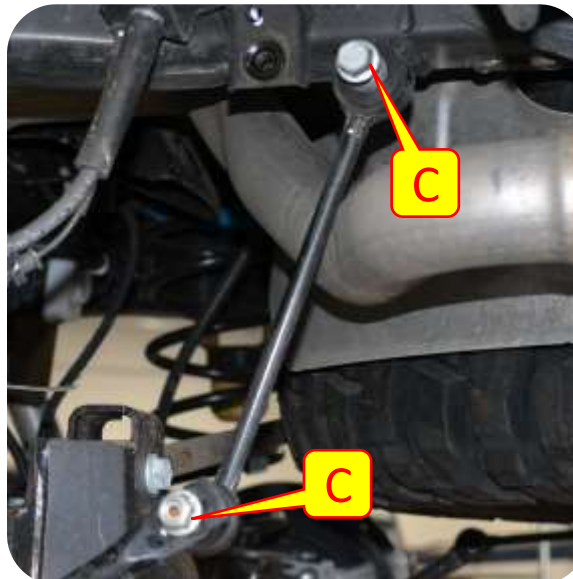
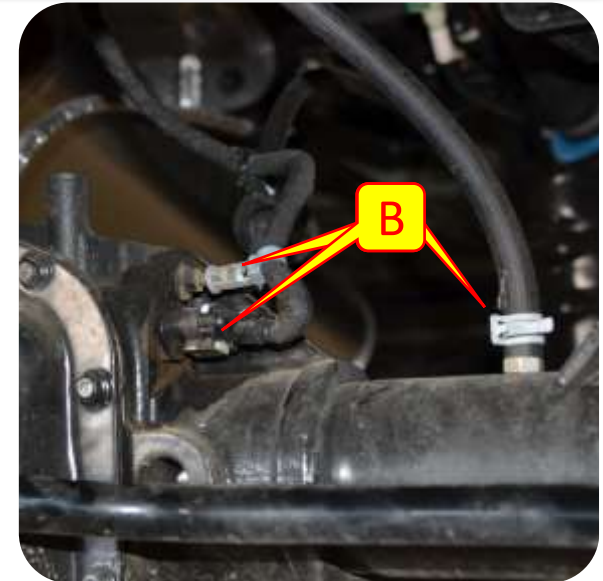
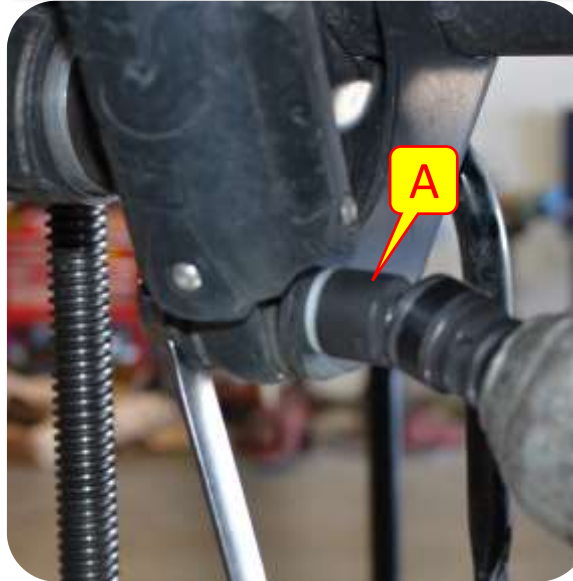

Section 3: Installation Instructions

Step 1: Remove Stock Components

- F. Remove the factory control arm bolts of the rear upper and lower control arms with a 23mm socket and 21mm wrench.
- G. Disconnect the E-Brake cable at the wheel end.

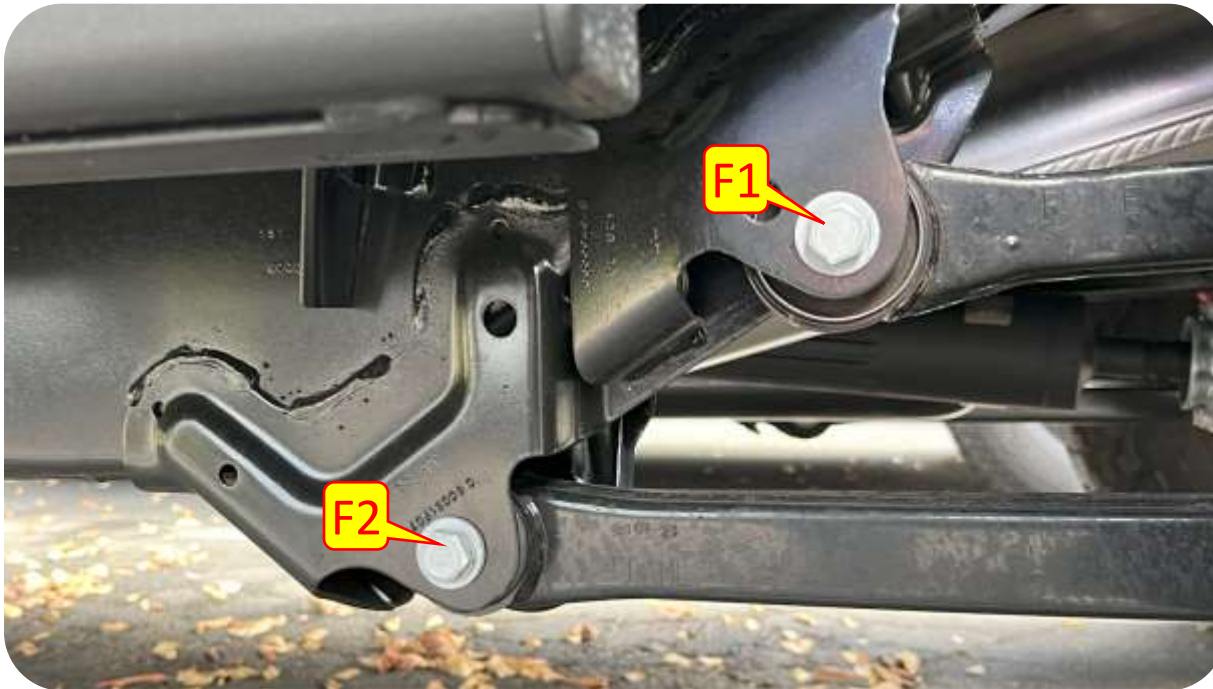

Section 3: Installation Instructions



Step 2: Gas Tank Removal

Important Note: It is required to cut off the factory rear control arm mounts at the frame for this installation. MetalCloak recommends removing the gas tank for optimal safety when removing this bracket; if you are uncomfortable removing the tank you should take your Jeep to an Authorized MetalCloak installer to have the work done by a professional.

Important Note: After removing the factory control arm mount MetalCloak recommends grinding the area smooth, clean, and then paint any of the exposed metal to help prevent rust.

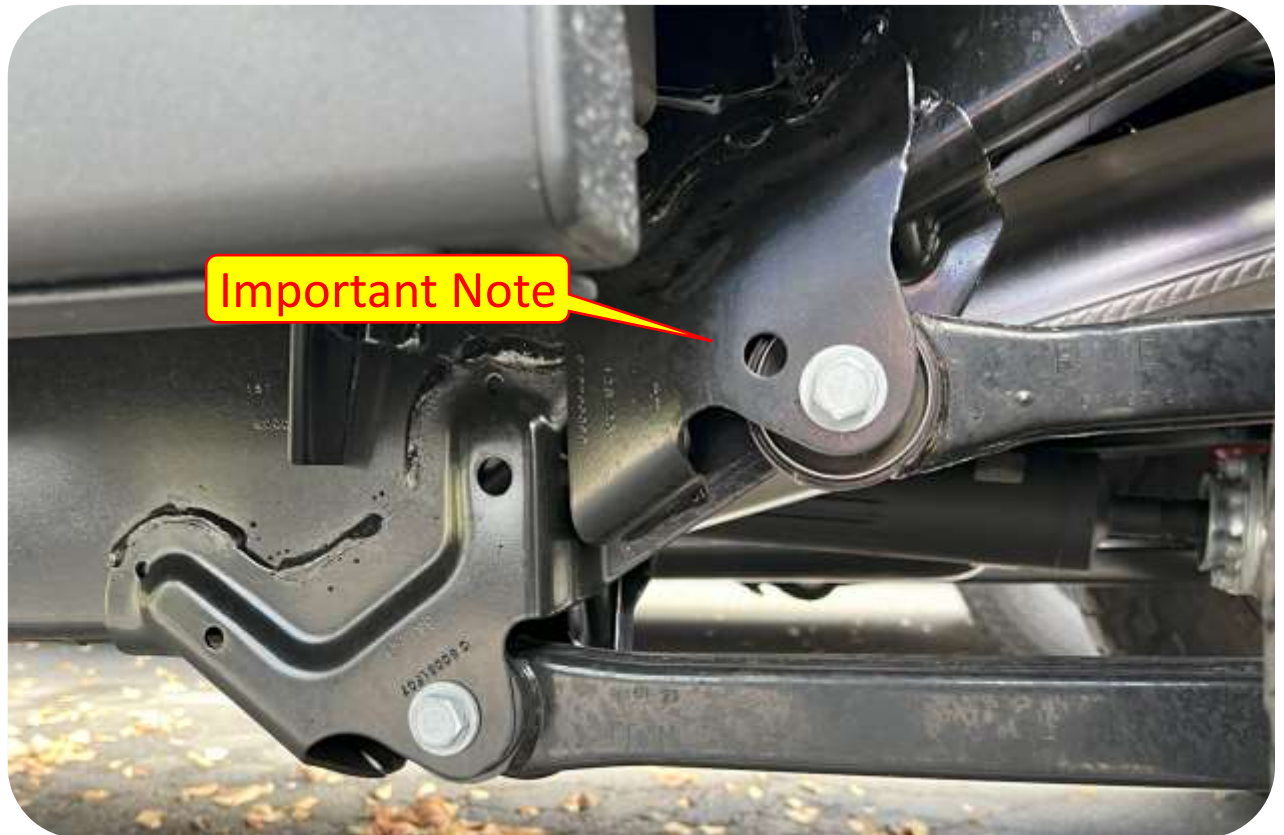

Section 3: Installation Instructions

Step 3: Rear Frame Bracket Installation

- H. Align the bracket with the frame making sure that the 2 holes on the bottom of the frame are centered and front most 2 holes on the frame are centered with the holes on the bracket.
- I. Secure the Mounting Bracket to the frame using a clamp or an assistant.
- J. Center mark your rear most side hole drill with a 1/2" drill bit.

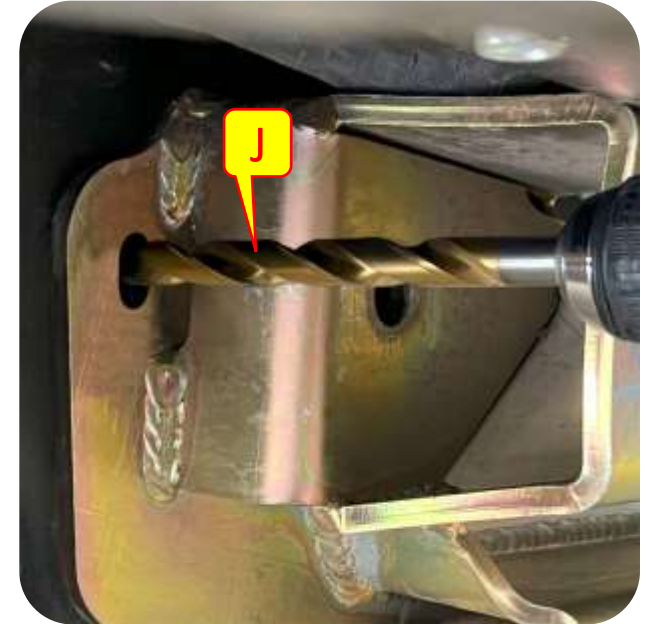
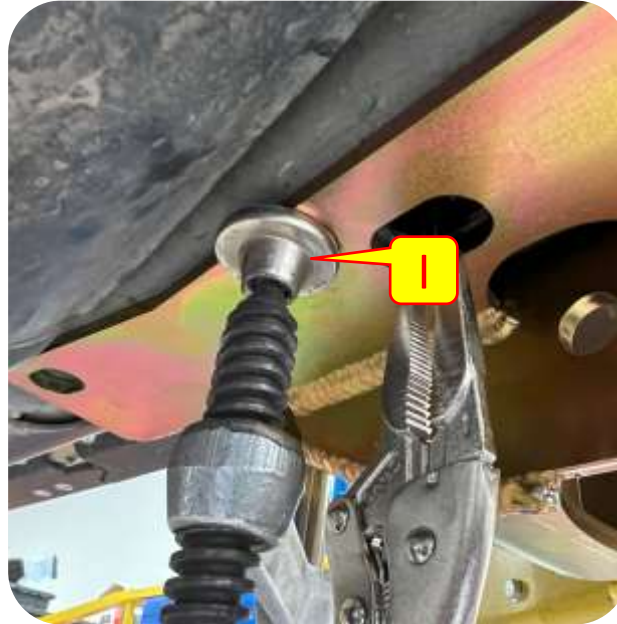
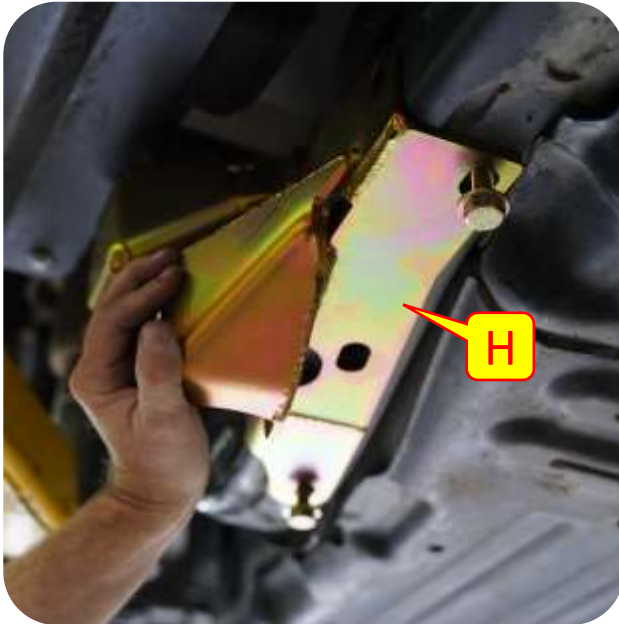

Section 3: Installation Instructions

Step 3: Rear Frame Bracket Install (Driver Side Gas JT / Passenger Side Diesel JT)

- K. Most JT will only have threaded inserts on the fuel tank side only (*Passenger Side on a Gas JT and Driver side on the Diesel*). When installing the bracket on the side opposite to the fuel tank you must use flag nuts JTF and JTR. Insert JTR through the hole in the side of the frame bolt end 1st (*K1*) and use your finger and a screwdriver to slide the flag nut down the frame to the rear most hole. The tail of this flag nut should fall through the slot in the bottom of the frame. (*K3*) next Install JTF through the same hole but this time inset it tale first. slid the nut to be over the front most hole in the bottom of the frame and again the tail of the flag nut should fall through the slot in the bottom of the frame. Optionally on some vehicle JTF and JTR can be installed though the slot in the bottom if the slot is large enough (*K2*). Use vice grips to hold each flag nut tail, install a 1/2 bolt into each flag nut from below (*L*).

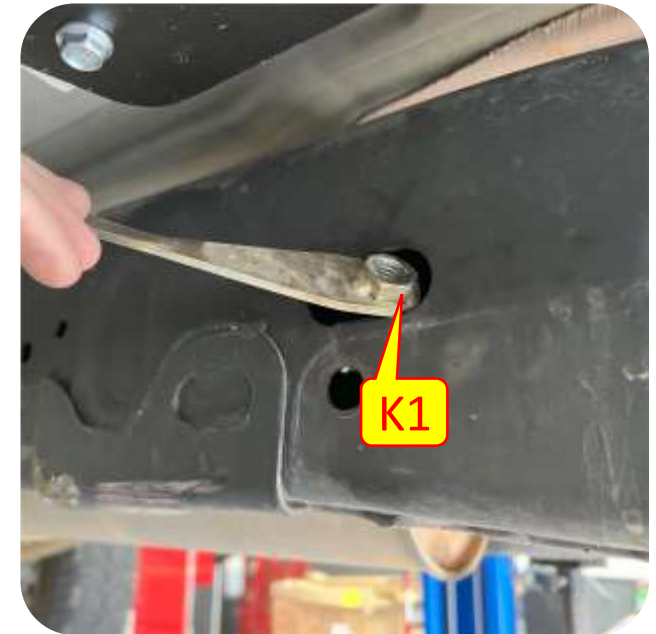

Section 3: Installation Instructions

Step 3: Rear Frame Bracket Install (Gas Tank Side)

- M. Insert the long flag nut labeled JTS through the access hole (*M1*) to the drilled-out bolt hole (*M2*). Install 1/2" bolt into flag nut and hand tighten. After bolt is started into flag nut, you may push the tail into the frame to not obstruct the installation of remaining 2 flag nuts.
- N. Insert the flag nut labeled JT through the access hole (*N1*) to the center bolt hole on the bracket (*N2*). Install 1/2" bolt into flag nut hand tight.



Section 3: Installation Instructions

Step 3: Rear Frame Bracket Install (Gas Tank Side)

- O. Insert the smallest flag nut through the access hole to the front hole just under the access hole and install 1/2" bolt into flag nut hand tight.
- P. Fully tighten all 1/2" bolts using a 3/4" socket and all M12 bolts (*bottom bolts*) using a 19mm socket.

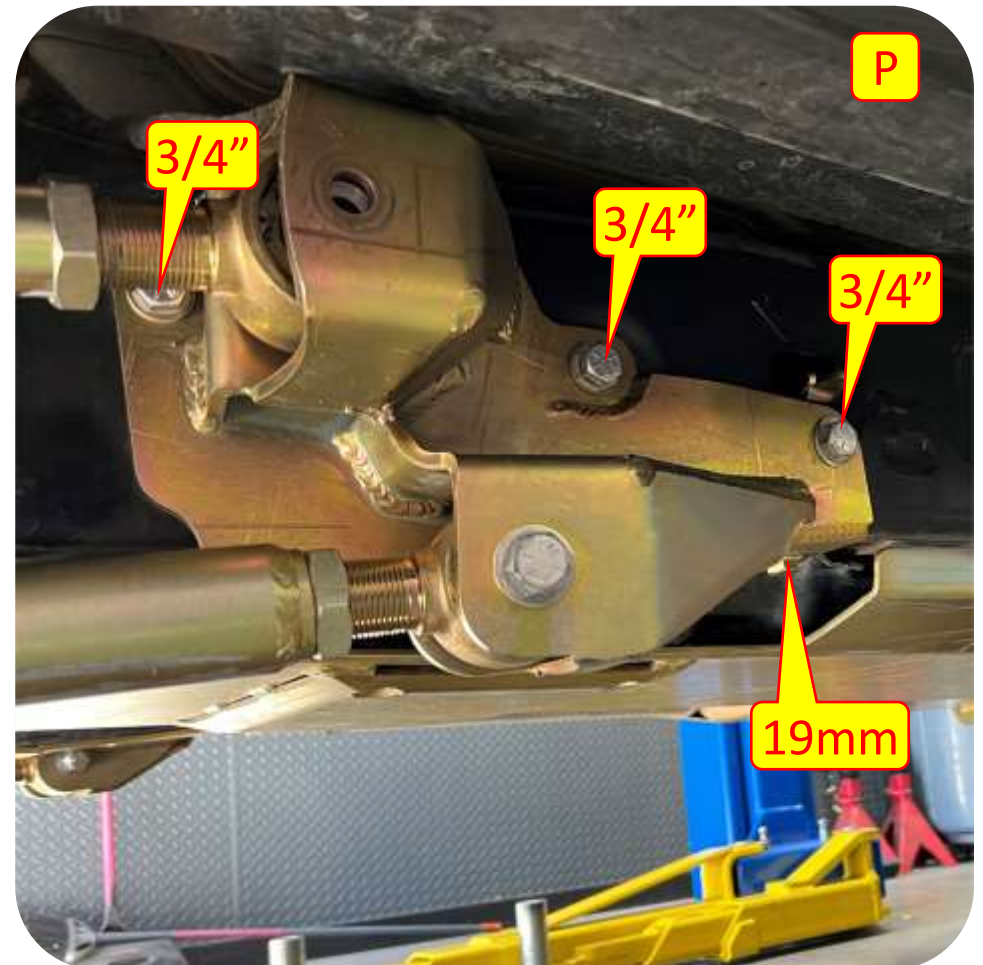

Section 3: Installation Instructions

Step 4: Axle Control Arm Correction Bracket Installation

- Q. Feed the E-Brake cable through the holes on the bracket and set the bracket into place with the bracket offset to the outside of the vehicle.
- R. Insert the crush sleeve into factory upper control arm mount and insert the provided 5/8" bolt and nut hand tight.
- S. Set lower arms to 37 1/2" eye to eye as a starting point and install using the provided 5/8" bolts and nuts making sure the lock nuts are at the frame.
- T. Set upper arms to 33 1/2" eye to eye as a starting point and install using the provided 5/8" bolts and nuts making sure the lock nuts are at the frame.

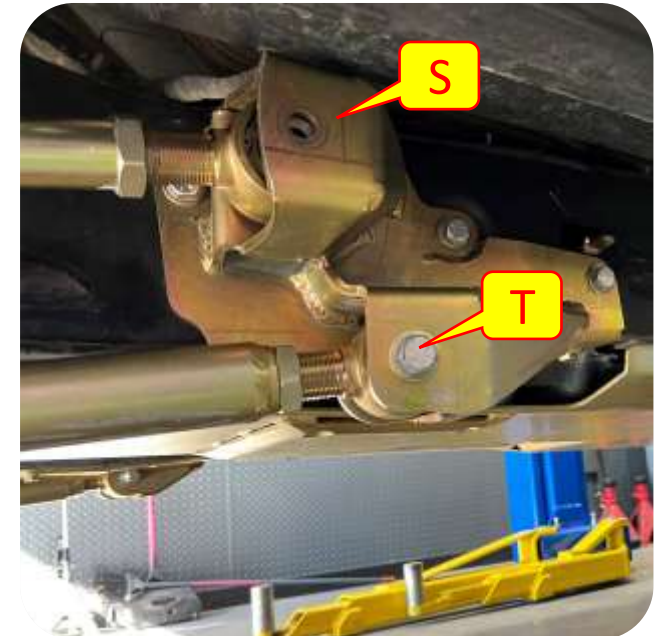
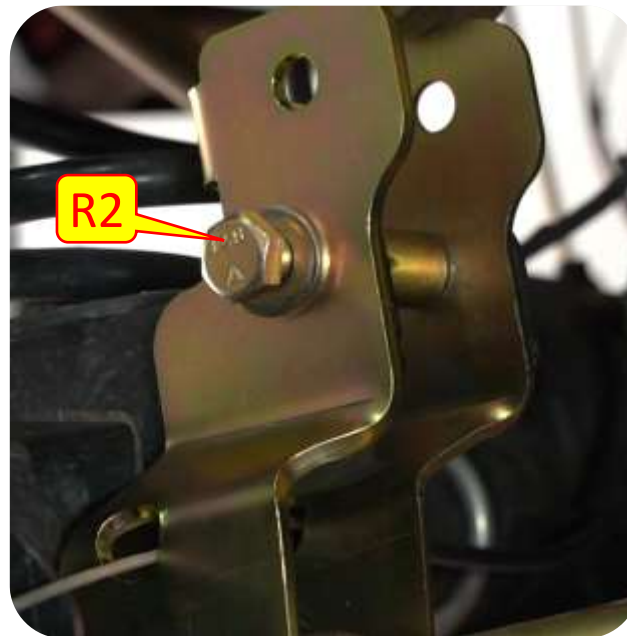
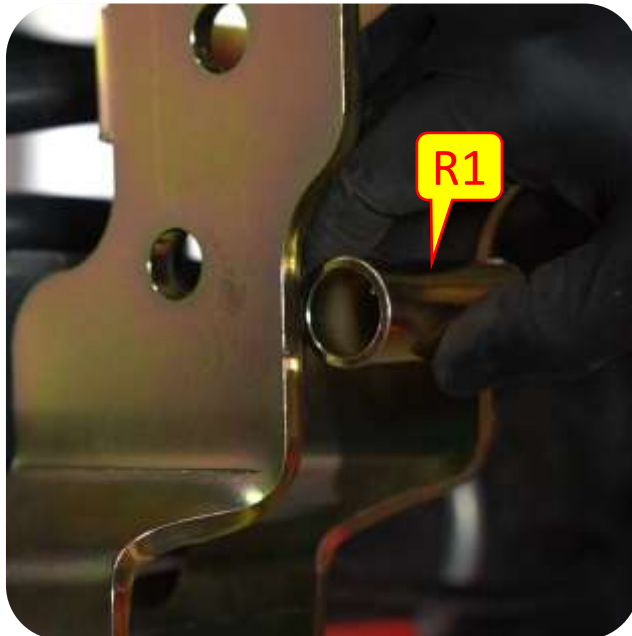
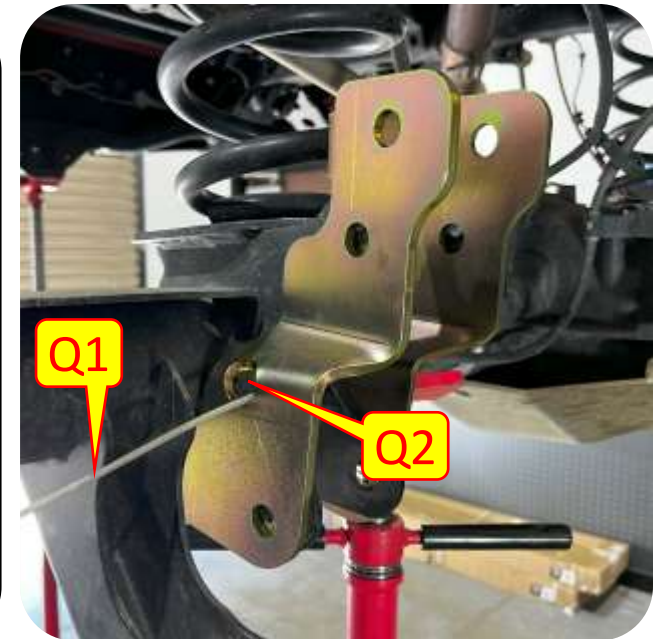

Section 3: Installation Instructions

Step 4: Axle Control Arm Correction Bracket Installation

- U. Working from the bottom to the top tighten the correction bracket bolts with a 15/16" socket and wrench.
- V. Reinstall the E-Brake.

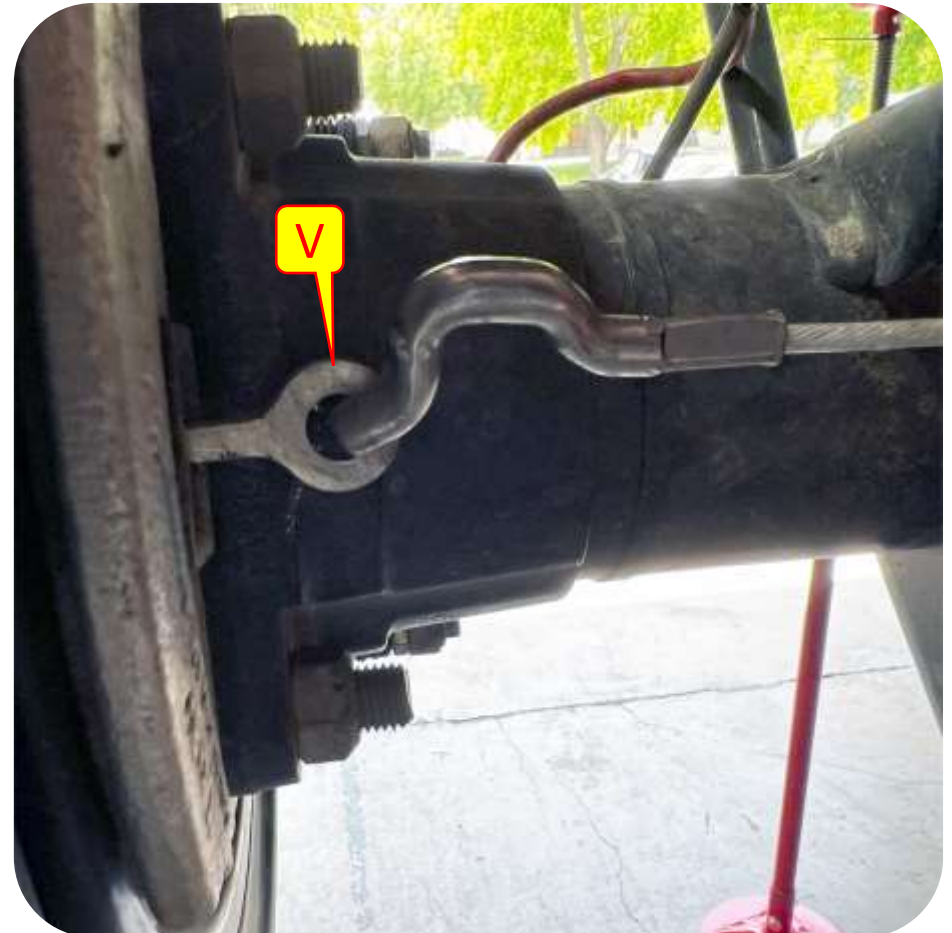
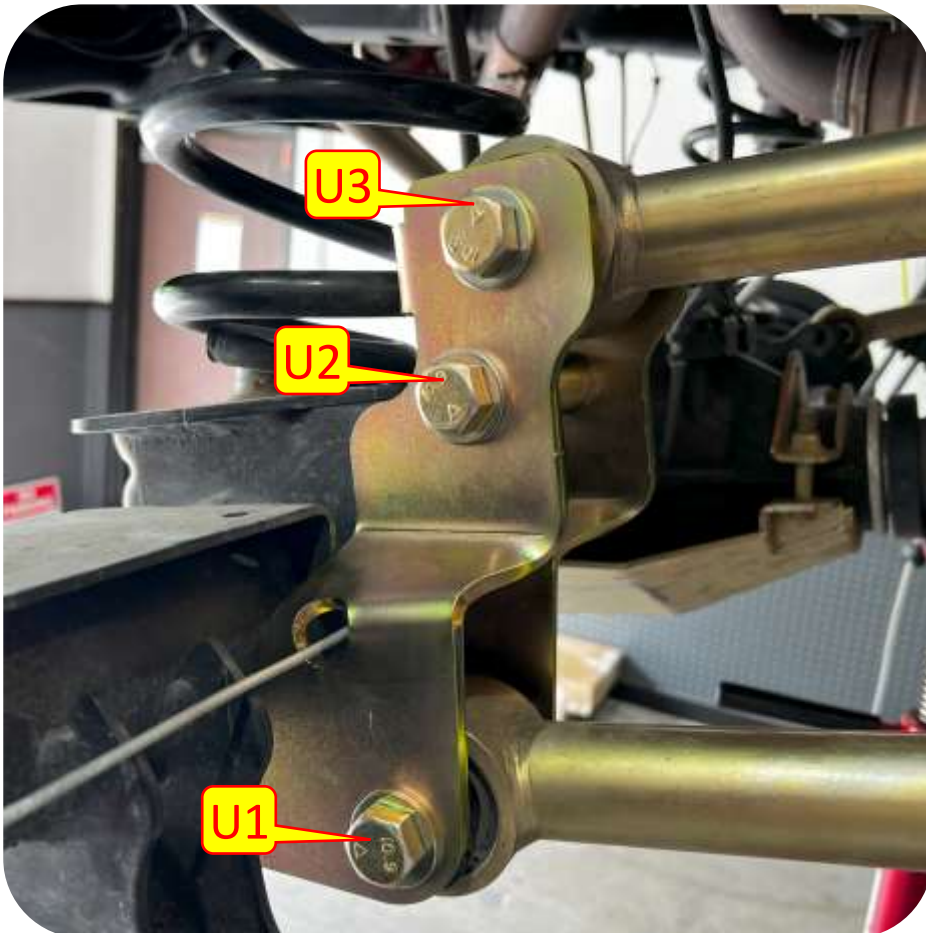

Section 3: Installation Instructions

Step 5: Install Rear Coils

- W. If the axle does not “droop” enough to allow the coil to be put in place a coil compressor can be used to compress the coil to allow fitment.
- X. Place the rear coil cup on top of the rear true dual rate coil.
- Y. Install rear true dual rate coils with the tightly wound coils oriented upward.
- Z. Slip the bottom of the coil onto the coil base on the axle.



Section 3: Installation Instructions



Step 6: Install MetalCloak Track Bar

AA. Install the MetalCloak Track Bar using the stock hardware. You may need to lower the vehicle to the ground to install one end of the track bar and tighten the hardware using a 21MM Socket and Wrench.



Section 3: Installation Instructions

Step 7: Sway Bar Links

BB. Using an 18mm socket Install the extended sway bar end links to the frame and on the sway bar.

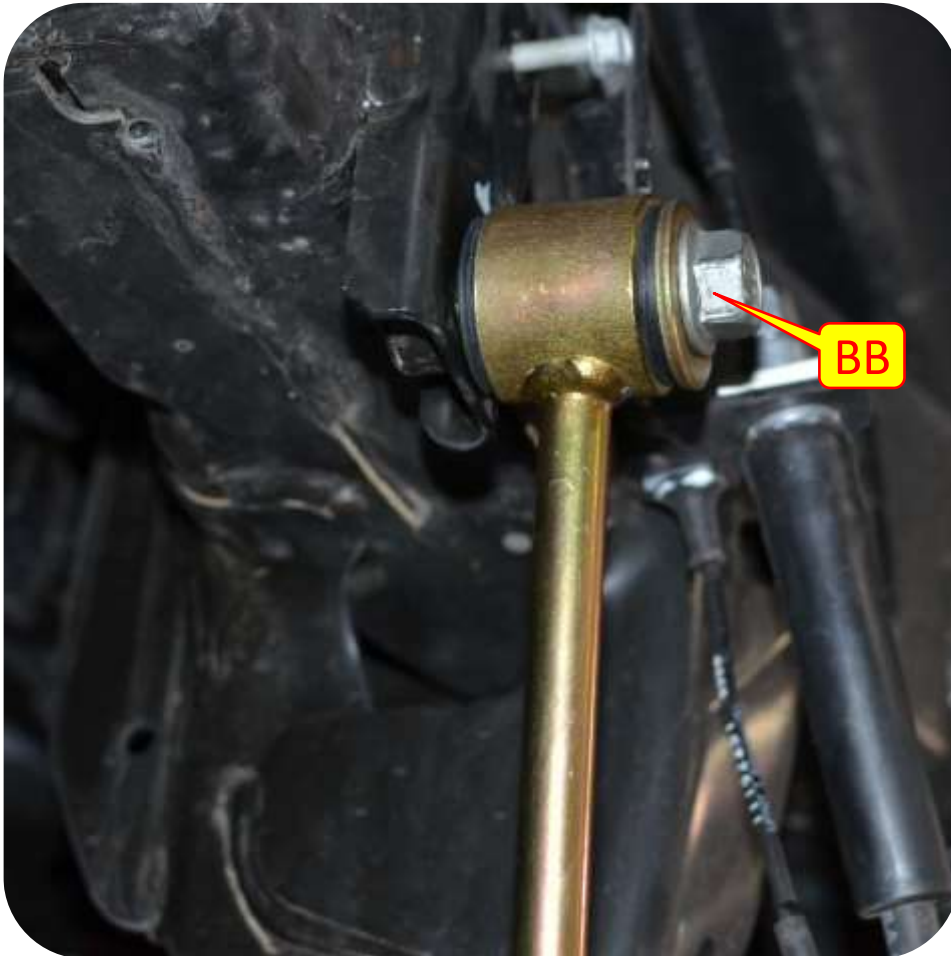

Section 3: Installation Instructions

Step 8: Install Rear 6Pak Shocks

CC. Using the provided hardware install the upper part of the 6Pak Shock (Bushing End) making sure to add the washer on the outside of the frame.

DD. Using the provided washer, spacers and hardware install the lower part of the 6Pak Shocks into the stock shock bracket. Make sure the red tubes are facing the front of the Jeep.

Important Note: When installing the lower part of the 6Pak on the driver side, make sure to install the provided washer on the inside of the jeep (passenger side of the bracket).

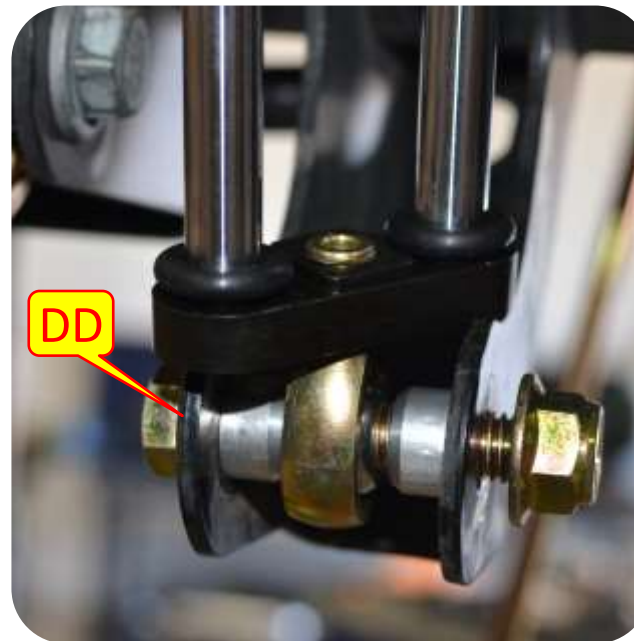
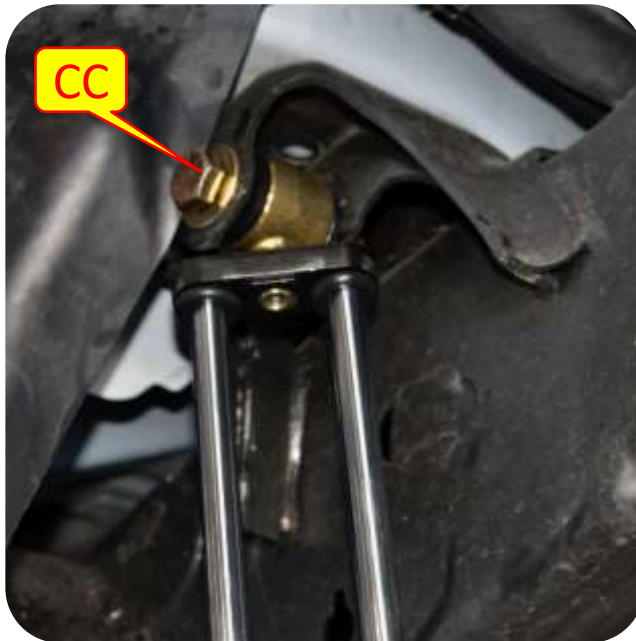

Section 3: Installation Instructions

Step 9: Install Rear Bump Stops

EE. Center the rear bump stop onto the rear axle bump stop plate and mark the holes in preparation for drilling.

FF. Center punch the marked holes.

GG. Drill a pilot hole at the marked location and work your way up to a 3/8" drill bit.

HH. Using a 1/2" wrench and a 3/16" allen socket tighten the provided hardware into the drilled locations.



Section 3: Installation Instructions

Step 9: Install Rear Bump Stops

- II. Install next puck (Side B) using the 1 3/4" woodscrews.
- JJ. Continue until desired bump stop height (Side A/Side B/ Side A/Side B).

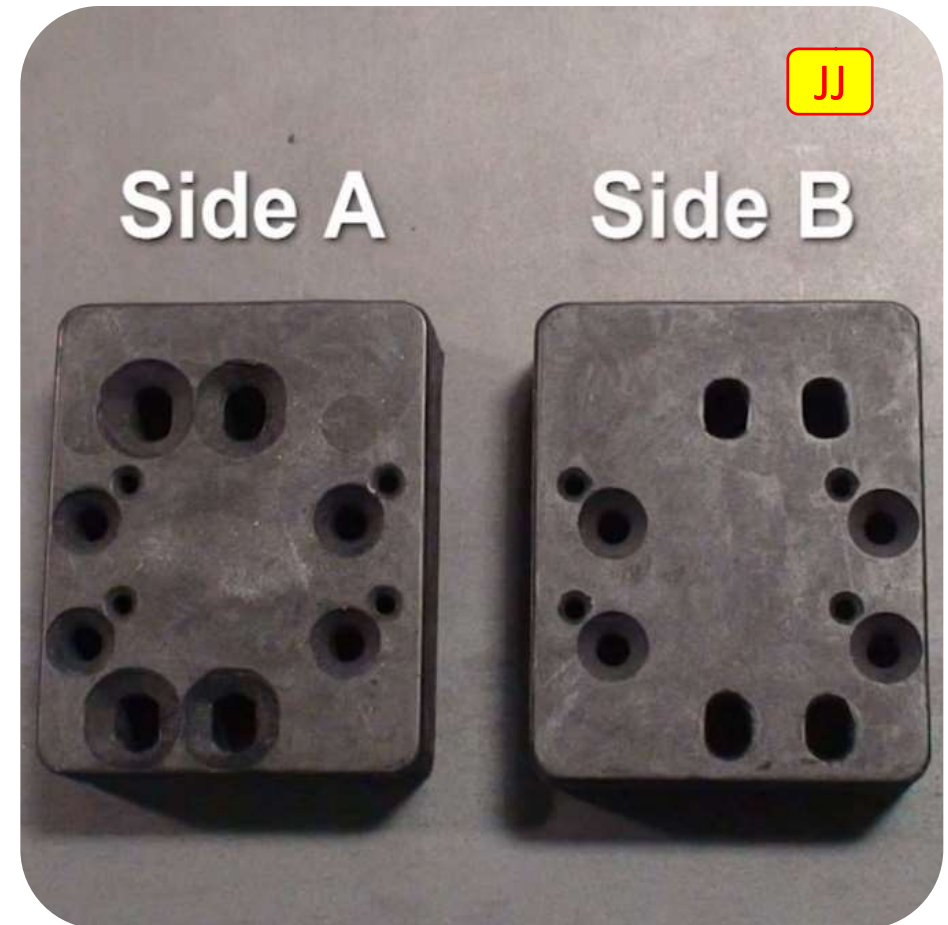

Section 3: Installation Instructions

Step 10: Rear Brake Line Installation

Important Note: MetalCloak recommends placing a drain pan under the caliper; fluid will leak out when removing brake lines.

KK. Carefully disconnect the brake line from the ABS line.

LL. Using pliers remove the stock brake line spring clip.

MM. Using a 12mm and 16mm wrench disconnect the stock brake line at the frame.

NN. Using a 15mm wrench disconnect the brake line from the caliper. **Save bolt.**

Note: Make sure the copper washer is removed from the caliper.

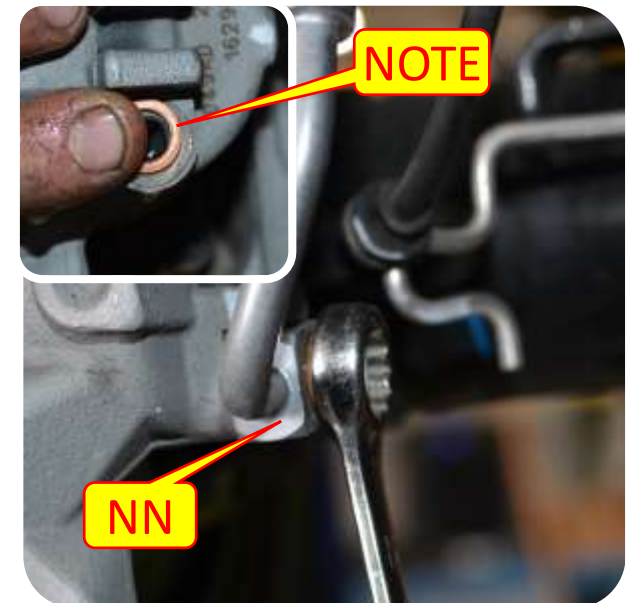
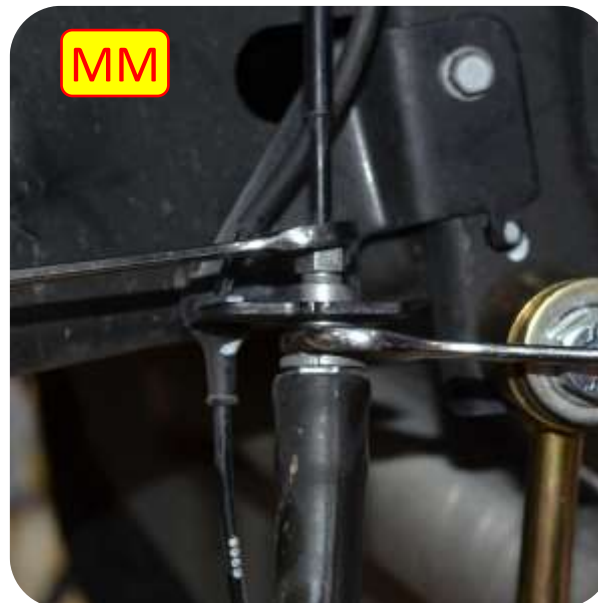

Section 3: Installation Instructions

Step 11: Rear Brake Line Installation

OO. Install the new brake line into the caliper using the stock bolt making sure to place a brass washer on each side of the brake line.

PP. Install the break line at the frame and install the provided spring clip.

QQ. Using a 12mm and 18mm wrench fully tighten the brake line at the frame.

RR. Using a 15mm wrench fully tighten the brake line at the caliper.

SS. Using zip ties reconnect the Brake Line to the ABS Line.

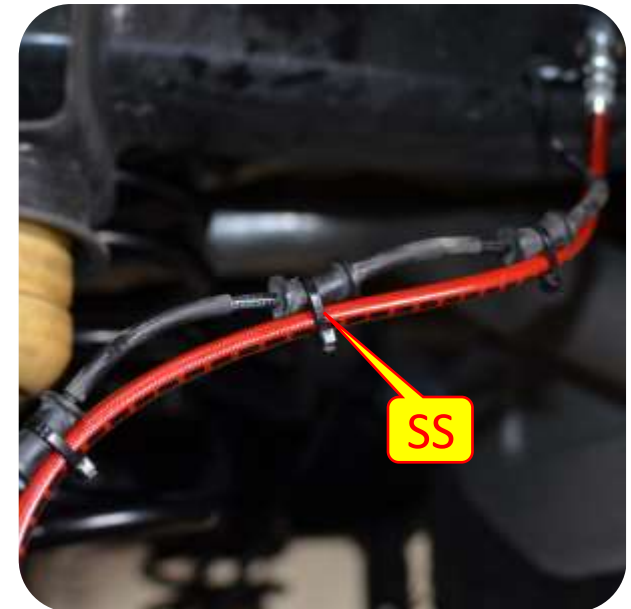
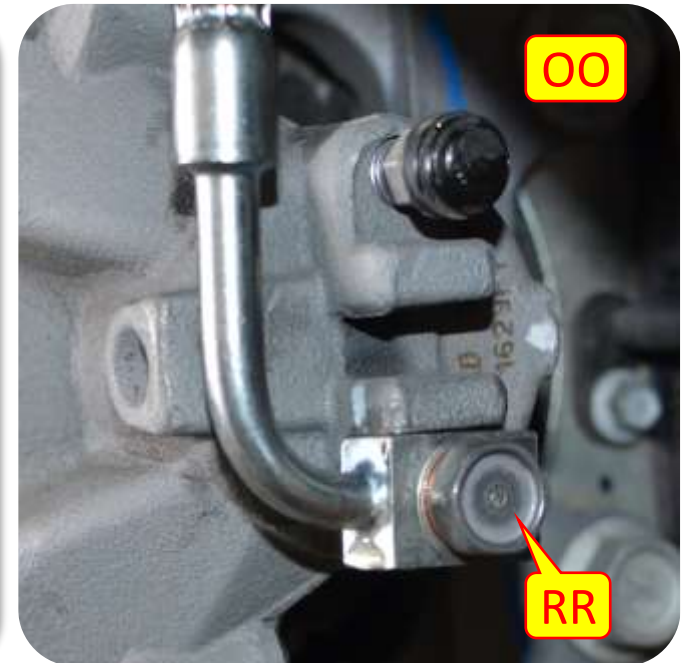

Section 3: Installation Instructions



Step 12: Finalize

- TT. Lower the vehicle to the ground and re connect the locker, breath tube, and wheel speed sensor lines, and emergency brake bracket to the axle.
- UU. Adjust the caster angle and toe as needed.
- VV. Once the caster is set, make sure to tighten all hardware and tighten the jam nuts on all control arms.

Section 3: Installation Instructions



Step 8: Bleed Brakes

CAUTION!! FAILURE TO PROPERLY BLEED THE BRAKE LINES WILL CAUSE YOUR BRAKES TO BE INEFFECTIVE.

Before your vehicle is ready to drive you will need to refill the brake reservoir and bleed the air out of the brake lines. If you are not experienced with this process, or have any reservations, consult a professional. For a full write-up of the brake bleeding process for your JEEP Wrangler JK, you can also refer to:

<https://wayalife.com/showthread.php/4335-MAINTENANCE-Bleeding-the-Brakes-on-a-Jeep-JK-Wrangler>

