



**PRODUCT: JT Lock-N-Load Long Arm, RockSport**

REV: B | 03-22-2024 | II-A3735/A3745

**READ INSTRUCTIONS IN FULL BEFORE INSTALLATION.  
QUESTIONS? CALL 916-631-8071 M-F 7:00 AM – 5:00 PM PST**

The MetalCloak experience includes the ease of installation of our products. We design for most contingencies, but installation may be different based on different Jeep condition, configuration and/or year.

We are continually trying to improve our products and instructions – please help us by providing feedback and pictures if you find any part of the instructions that do not match your particular Jeep or are not easily understandable.

If you have any difficulties at all, please give us a call. Thank you and enjoy your MetalCloak Products!

---

**WARRANTY INFORMATION:** This article is sold without warranty expressed or implied. No warranty or representation is made as to this products ability to protect the user from injury or death. The user assumes that risk. The effectiveness, warranty and longevity of this equipment are directly related to the manner in which it is INSTALLED, USED and/or MAINTAINED. THE USER ASSUMES ALL RISK. By purchasing this product and opening the packaging, purchasers expressly acknowledge, understand and agree that they take, select and purchase these MetalCloak products from Armored Works, LLC, its affiliates and distributors and agents as is and with all faults. The entire risk as to the quality and performance of these MetalCloak products is with the purchaser. Working on your vehicle can be a dangerous activity. If you are unsure of what you are doing, please leave mechanical or safety critical work to a skilled mechanic. We take no responsibility for the incorrect use and/or installation of MetalCloak products.

## Section 1: Tools & Notes on Installation



**Tools Required:** This list is the recommended tools for ease of installation. Other versions of the same tool can be used. For example, Allen Wrenches instead of Allen Drive Sockets. Be sure to use metric on metric and SAE on SAE.



Socket & Ratchet Wrench  
10" Socket Extension

7MM, 10MM, 13MM Sockets  
18MM, 21MM, 24MM Sockets  
9/16" , 13/16" , 15/16" Sockets  
3/4", 1 1/8" Socket



Metal Head Hammer

Metric Hex Sockets  
and/or Hex (Allen) Wrenches



Tape Measure

3/8" Flare Nut Wrench (10mm will  
work) for Brake Lines



Cut-Off Disc and Grinder

Drill  
Drill Bits (1/8" up to 1/2")  
Center Punch



**HOW TO USE THIS GUIDE:** The installation guide contains ALL steps for installation. Please read and follow the instructions in order of each page top to bottom, and left to right.

**Jeep Model:** Instructions may apply to multiple Jeep models, but are labeled separately where appropriate (i.e. TJ vs. LJ).

**Options:** Because of the number of component options we offer, these instructions may contain steps that will not match your particular configuration. You can skip these steps.

**Images:** Pictures are provided and parts are labeled throughout the instructions. Each text box contains guidance based on the pictures next to it. The text will refer to alphabetical labels (A, B, etc.) found in the images.

**Installation Notes:** Terms may be used in the body of the instructions that you may not be familiar with, if you have any questions feel free to contact us at the number below, or email [techhelp@metalcloak.com](mailto:techhelp@metalcloak.com)

**QUESTIONS:** Any questions or comments about the instructions? Call us at 916-631-8071 M-F 7:00 AM – 5:00 PM PST.

# Section 2: Product Components

DC-0001 Rev B

SHEET 1 OF 1

ITEM	PART NUMBER/DESCRIPTION	QTY.
1	1161 BRAKE LINE KIT, JT REAR 24L	1
2	6361 SKID PLATE SYSTEM UPGRADED CROSS-MEMBER, JLU JT	1
E 3	7040 BUMP STOP KIT, 1.0-4.0 JK FRONT	1
4	7043 BUMP STOP KIT, 1.0-4.0 REAR	1
5	7231 RADIUS ARM KIT, FRONT JK	1
6	7232 LOCK-N-LOAD RADIUS ARM KIT, JK	1
7	7271 SWAY BAR LINK KIT, 12.25IN JT REAR	1
8	7295 LONG ARM MOUNT LOWER, FRONT JL-JT	1
9	7296 RADIUS LONG-ARM SET, JL FRONT LOWER	1
10	7403 TRACK BAR RELOCATION BRACKET, JT REAR	1
D 11	7644 TRACK BARS, JL FRONT+REAR	1
12	FA-1005 ZIP TIE DOUBLE LOCK, 8IN, UV BLACK	2



  

C	OPTIONS:	
	1) SHOCKS:	
	NO SHOCKS	(A5902)
	CHOOSE YOUR OWN	(A5100)
	STOCK SHOCKS	(A5104)
ROCKSPORTS	(1061)	
6-PAK SHOCK JT	(A5105)	
B	2) ENGINE:	
	3.6L GAS	(7685-G)
	DIESEL	(7685-D)
B	3) RUBICON SWAYBAR LINKS	(7015)
	NON-RUBICON QD-LINKS	(7614)
B	4) REAR ARM SELECTION	
	REAR BOLT ON LONG ARM	(7713)
	SHORT ARM W/ CORRECTION	(7262)

A	THE INFORMATION CONTAINED ON THIS DRAWING IS THE EXCLUSIVE PROPERTY OF ARMORED WORKS, LLC. UNAUTHORIZED REPRODUCTION IS PROHIBITED.	 A DIVISION OF ARMORED WORKS, LLC
	DO NOT SCALE DRAWING <b>PART NUMBER/DESCRIPTION</b> A3745 JT GLADIATOR RADIUS ARM LOCK-N-LOAD 4.5	

## Section 2: Product Components

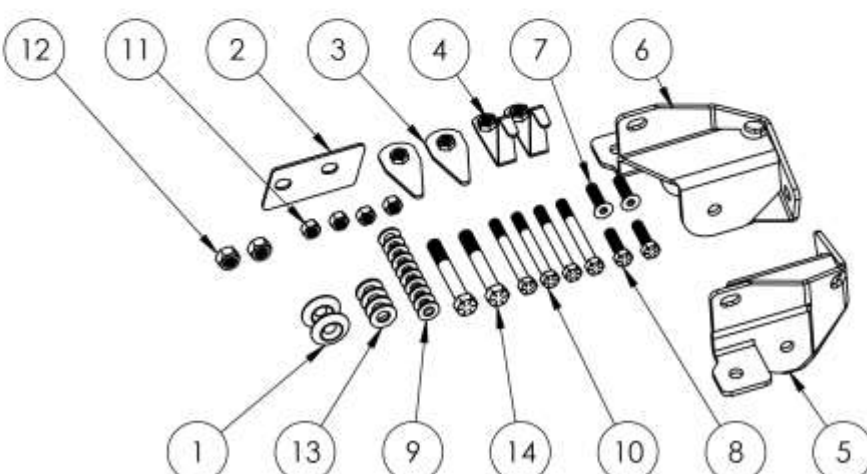
	1	2	3	4	5	6	7	8	
	ITEM.	PART NUMBER / DISCRIPTION						QTY.	
E	1	CP-3084 BEVELLED SKID WASHER						2	
	2	SS-0325 BACKING PLATE, LONG-ARM MOUNT LOWER, FRONT JL JT						1	
	3	WM-5897 WELDMENT, FLAG NUT .5-13, LOWER LONG-ARM MOUNT JL JT						2	
	4	WM-5898 WELDMENT, FLAG NUT 5-13, LONG ARM MOUNT JL JT						2	
	5	WM-5954 WELDMENT, LONG-ARM MOUNT LOWER, FRONT JL JT						1	
	6	WM-5954-P WELDMENT, LONG-ARM MOUNT LOWER, FRONT JL JT						1	
	HK-7295								
D	7	FS-08081 SFHCS, 0.5-13 X 1.75L STL G8 ZINC						2	
	8	FS-08173 HHCS, 0.5-13 x 1.75L STL G8 ZINC FULL THREAD						2	
	9	FS-08307 WASHER, 0.53ID X 1.06OD X 0.20TH STL GR8 GOLD ZINC						10	
	10	FS-08322 HHCS, 0.50-13 x 4.50L STL G8 GOLD ZINC						4	
	11	FS-08359 TOPLOCK NUT, 0.5-13 X .44H STL GC STL ZINC						4	
	12	FS-10130 TOPLOCK NUT, 0.63-18 X 0.55H STL GC CAD						2	
	13	FS-10161 WASHER, 0.66ID X 1.31OD X 0.14TH STL GR8 GOLD ZINC						4	
	14	FS-10295 HHCS, 0.63-18 X 4.25L STL G8 ZINC						2	
C									
B									
A	THE INFORMATION CONTAINED ON THIS DRAWING IS THE EXCLUSIVE PROPERTY OF ARMORED WORKS, LLC. UNAUTHORIZED REPRODUCTION IS PROHIBITED. <b>DO NOT SCALE DRAWING</b>						 A DIVISION OF ARMORED WORKS, LLC		
	<b>PART NUMBER/DESCRIPTION</b> 7295 LONG ARM MOUNT LOWER, FRONT JL-JT								

# Section 2: Product Components

DC-0001 Rev B

SHEET 1 OF 1

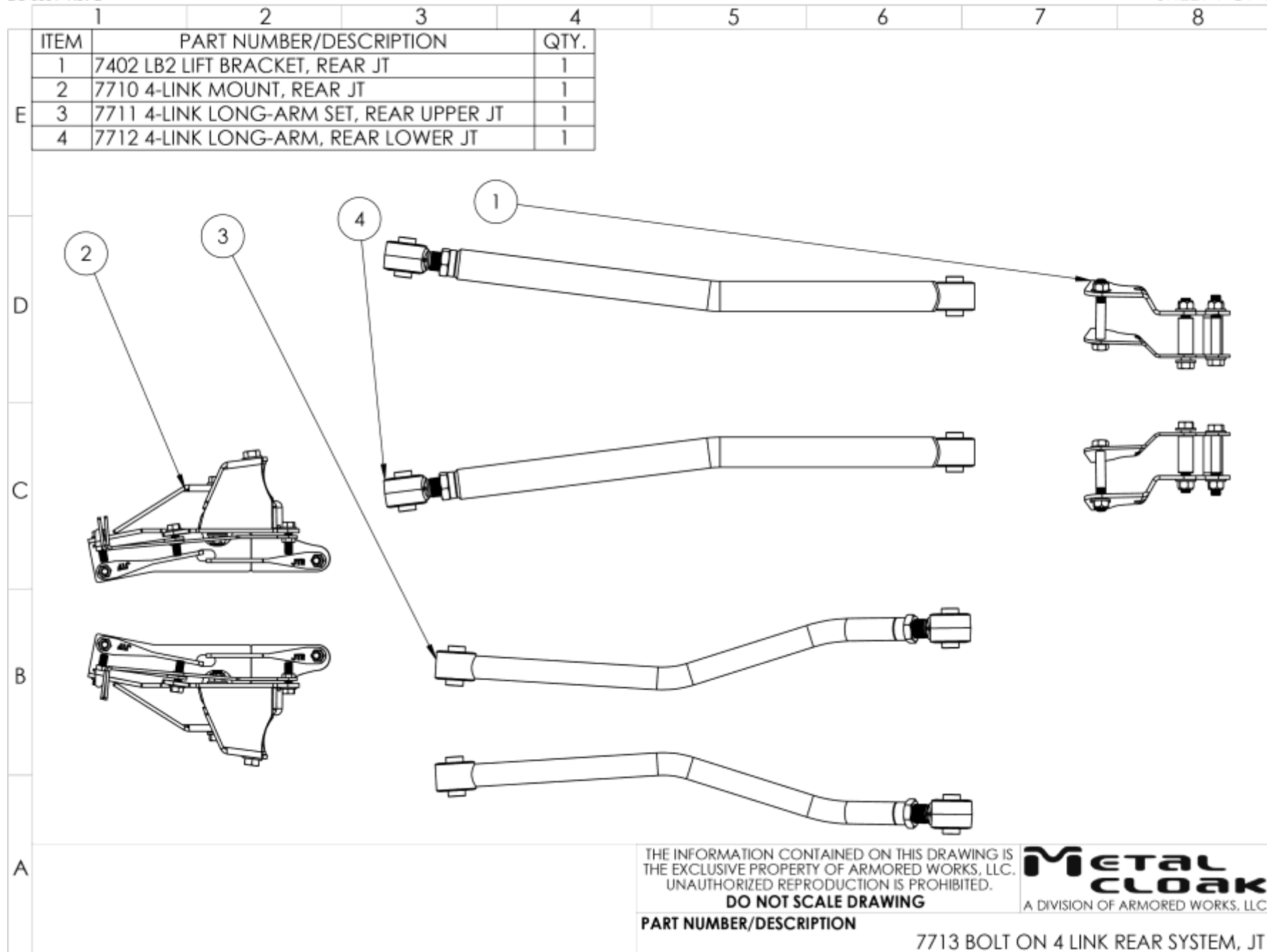

## Section 3: Installation Instructions

**Important Note:** MetalCloak recommends replacing the factory drive shaft. The factory drive shaft binds at transfer case side and the factory drive shaft is too short for additional travel. An aftermarket drive shaft clears t-case and is optimal for maximum travel

Factory Drive Shaft T-Case Bind

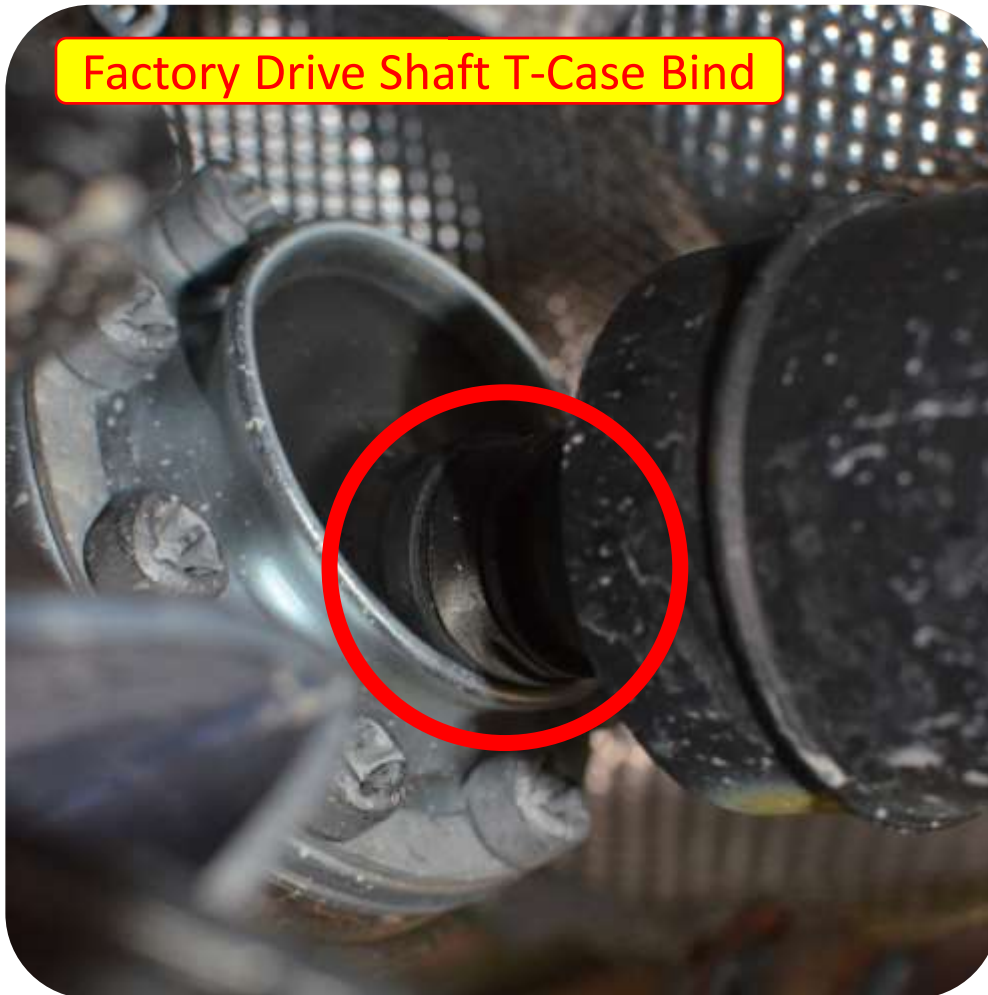

Factory Drive Shaft Misalignment



Aftermarket Drive Shaft Correction



## Section 3: Installation Instructions



**Important Note:** *MetalCloak does not recommend powder coating your True Dual Rate Coils. The baking process in powder coating can, in some cases, cause the metallurgical properties of the coils to be changed, resulting in the loss of the lift properties of the coils. As such, the process of powder coating the coils will void any warranty stated or implied in relation to the coils.*

**Important Note:** *To install lift components you will need to fully 'droop' your suspension in the front and rear (not at the same time). We strongly recommend that the vehicle be placed on an automotive lift and that all appropriate safety precautions be taken to secure the vehicle while it is off the ground. Always use the necessary axle stands (or equivalent) to support the axle when the suspension components are disconnected for safety, and to ensure the integrity of your suspension system during the installation process.*

## Section 3: Installation Instructions

### Step 1: Remove Stock Components

- A. Disconnect front sway bar links using a 18MM wrench and 6MM Allen Wrench. **Save all Hardware**
- B. Using a 10MM Socket disconnect the brake line brackets that is attached to the frame. **Save all Hardware.**

**Important Note:** The brake line on the lower front control arms (drivers and passenger side) must be removed from the bracket. It may be pried out or cut; be VERY careful not to damage the brake line!!!

**Important Note:** To help prevent strain on the brake lines MetalCloak recommends clipping all zip ties attached to the brake lines.

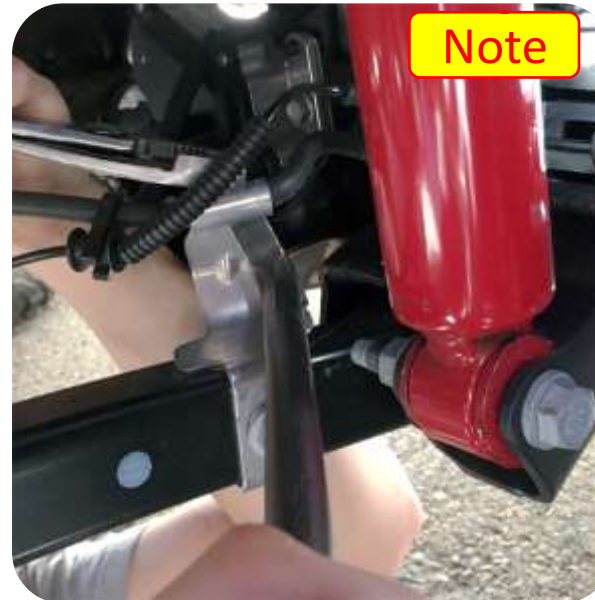
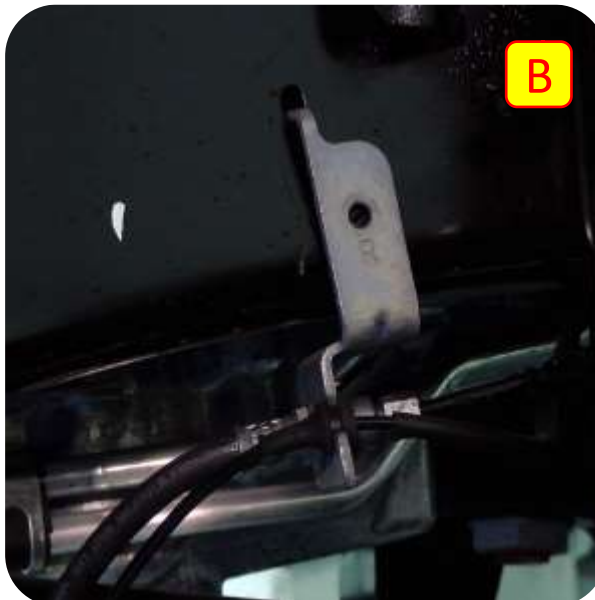
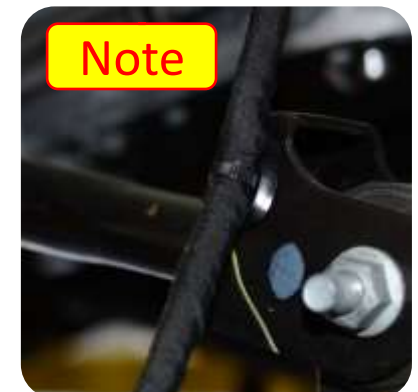



## Section 3: Installation Instructions

### Step 1: Remove Stock Components

**Important Note:** Disconnect any electronics attached to the axle (Locker plug, Front axle disconnect plug, etc.)

- C. Using a 21MM Socket disconnect the stock track bar. Save all hardware.
- D. Use a 18MM Socket and Wrench to remove the shocks. Save all hardware
- E. Remove stock springs, and any spacers that have been used if vehicle has been previously lifted.

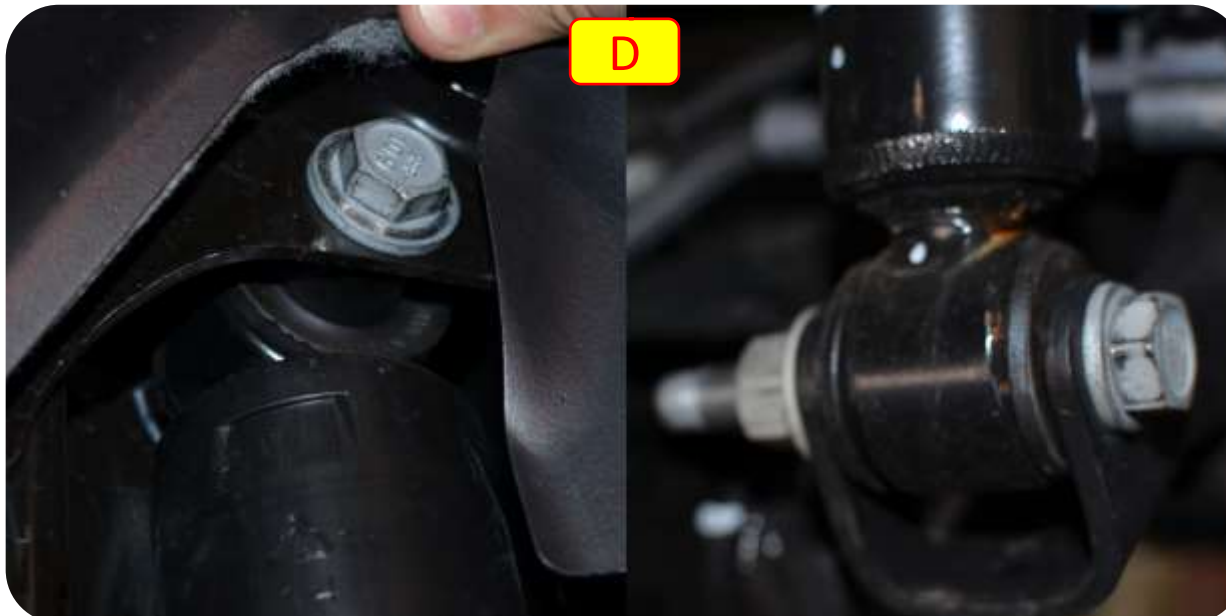

## Section 3: Installation Instructions



### Step 1: Install MetalCloak Crossmember

**Note:** Before removing the crossmember support the transmission and transfer case with jackstands.

- F. Remove the factory cross member and install the provided MetalCloak cross member using 21mm socket at the transmission mount, a 13mm socket for the exhaust mount and 18mm socket and wrench for the crossmember.

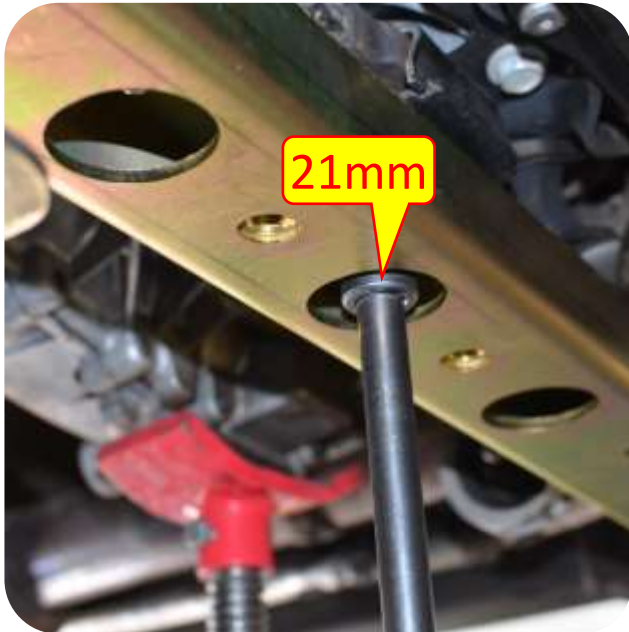

## Section 3: Installation Instructions

### Step 2: Disconnect Front Control Arms (*Stock Control Arms*)

**Note:** Make sure to use jack stands to support the axle before removing the control arms.

**Note:** The brake line on the lower front control arms (drivers and passenger side) must be removed from the bracket. It may be pried out or cut; be VERY careful not to damage the brake line!!!

**Note:** On the passenger side upper control arm you will need to cut the stock bolt as the exhaust interferes with the bolt removal.

- G. Disconnect the upper control arm heat shield on both sides at the frame using a 10MM Socket. Save heat shields and all hardware.
- H. Use a 24mm Socket & Wrench to remove the stock bolts from the front lower control arms. **Save all hardware.**
- I. Using a 18mm wrench and socket remove the Front Upper Control Arms. **Save all hardware.**

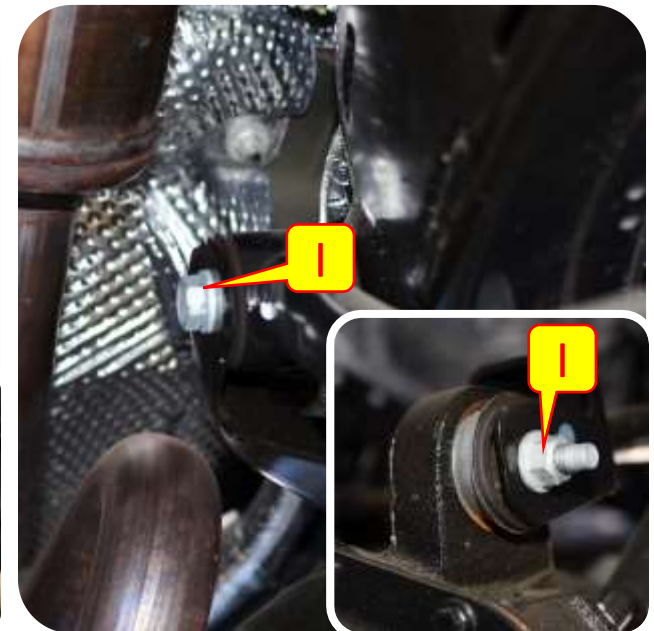
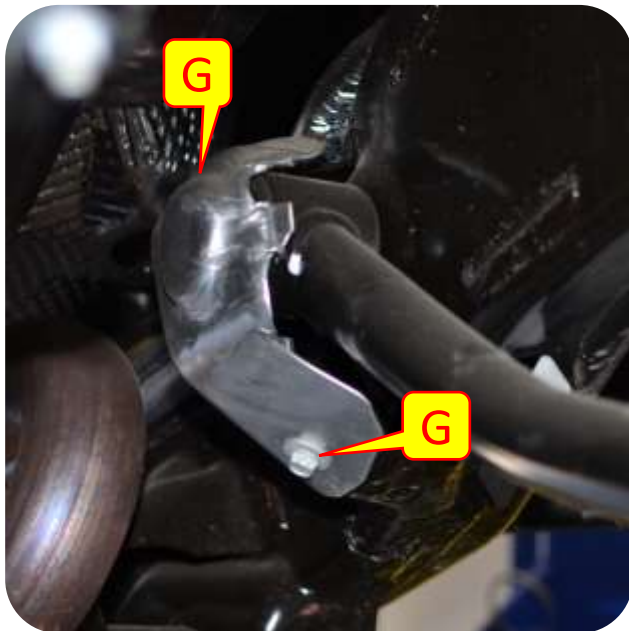

## Section 3: Installation Instructions



### Step 2: Disconnect Front Control Arms (*MetalCloak Mid Arms*)

**Note:** Make sure to use jack stands to support the axle before removing the control arms.

- J. Disconnect the front lower control arms using a 24mm socket & wrench. **Save Hardware.**
- K. Disconnect the front upper control arms using a 3/4" socket on the passenger side and a 18mm socket and wrench on the driver side. **Save Hardware.**



## Section 3: Installation Instructions

### Step 3: Removing Stock Control Arm Mounts

- L. Using a cut off wheel & grinder or torch remove the factory front control arm brackets from the frame.
- M. Clean and paint any exposed metal to prevent rust.

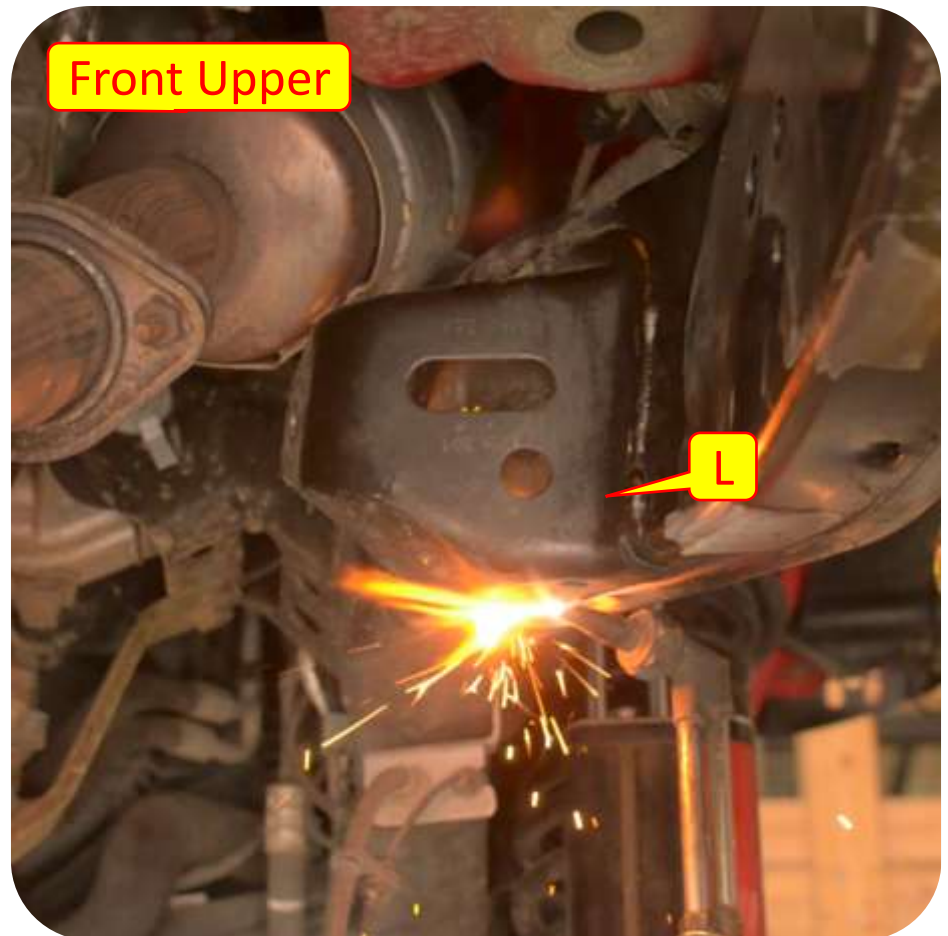
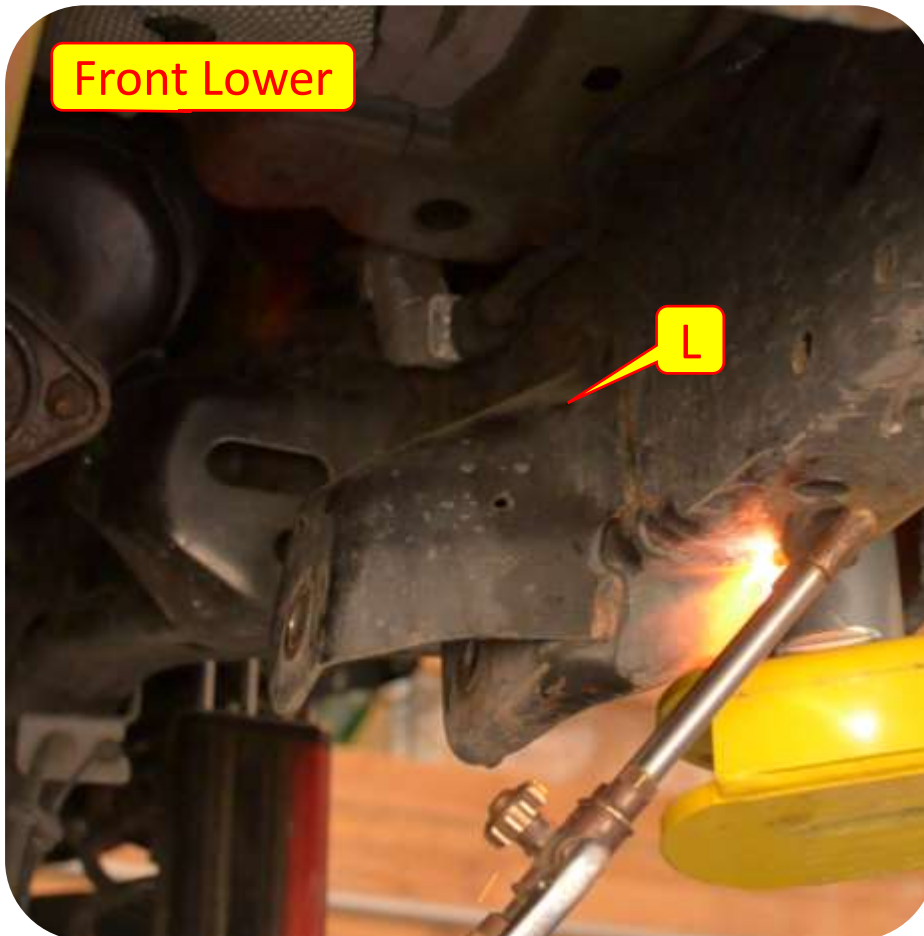

## Section 3: Installation Instructions



### Step 4: Install the Front Lower Control Arm Bracket

N. Install the lower control arm bracket to the crossmember using the provided 1/2" bolts (3/4" head), washers and nuts and hand tighten.

**Note:** *The passenger side lower control arm bracket comes with a shim to be placed between the bracket and the crossmember.*



## Section 3: Installation Instructions

### Step 4: Install the Front Lower Control Arm Bracket

- O. Insert flag nut (*BOM#3*) into the frame and install 5/16" allen bolt and skid washer through the control arm bracket at the bottom of the frame.
- P. Insert flag nut (*BOM#4*) into the side of the frame and install 3/4" bolt through control arm bracket and frame.
- Q. Tighten all lower control arm bracket hardware.

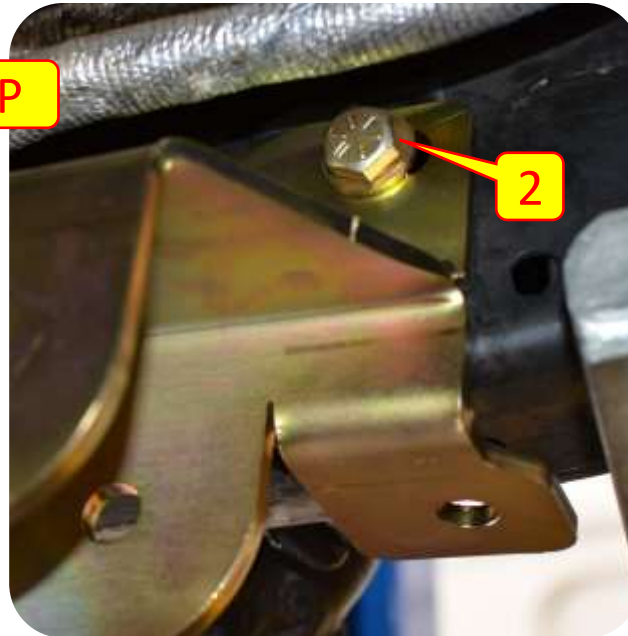
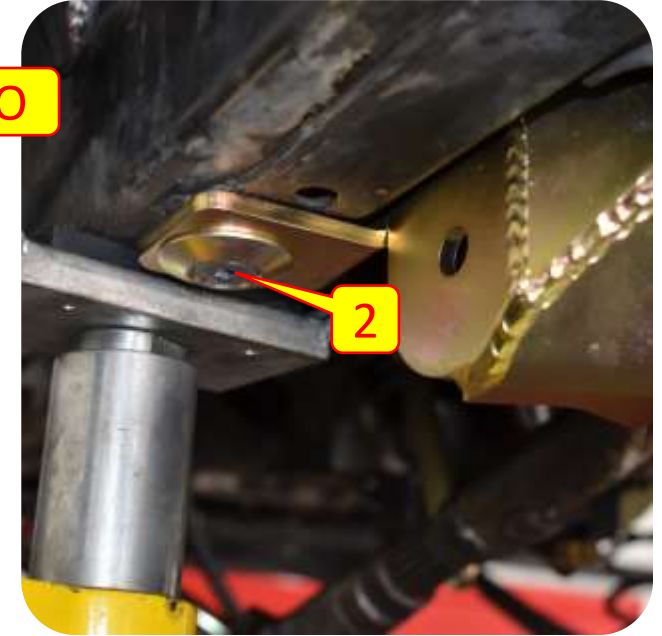

## Section 3: Installation Instructions

### Step 4: Install the Front Lower Control Arm Bracket

**Note:** Measure the lower front control arms to 37 1/2" and upper control arms to 16 1/4" eye to eye. These control arm specifications are just starting points. ALL JEEPS ARE DIFFERENT. MetalCloak recommends seeing a suspension specialist for correct control arm lengths for YOUR Jeep.

- R. Install the provided MetalCloak Lower radius arms into the axle and bracket at the crossmember using 15/16" socket and wrench at frame and factory 21mm bolt at axle.
- S. Install the upper radius arm on the passenger side using a 3/4" socket and wrench at the lower arm side and at the axle using a 18mm socket and wrench.
- T. Set the caster to 4-6 degrees.
- U. Install the Lock-N-Load on the driver side using a 3/4" socket and wrench at the lower arm side and at the axle using a 18mm socket and wrench.

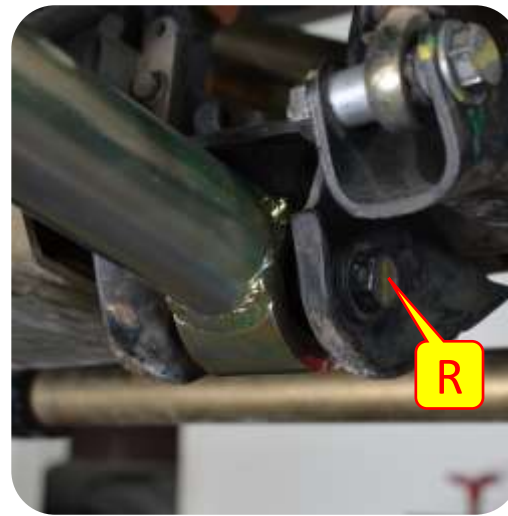
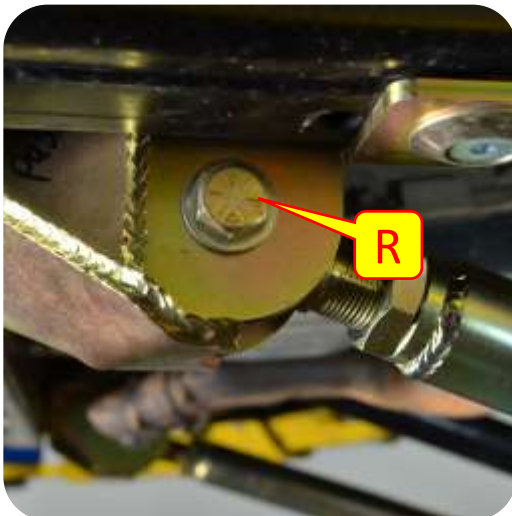
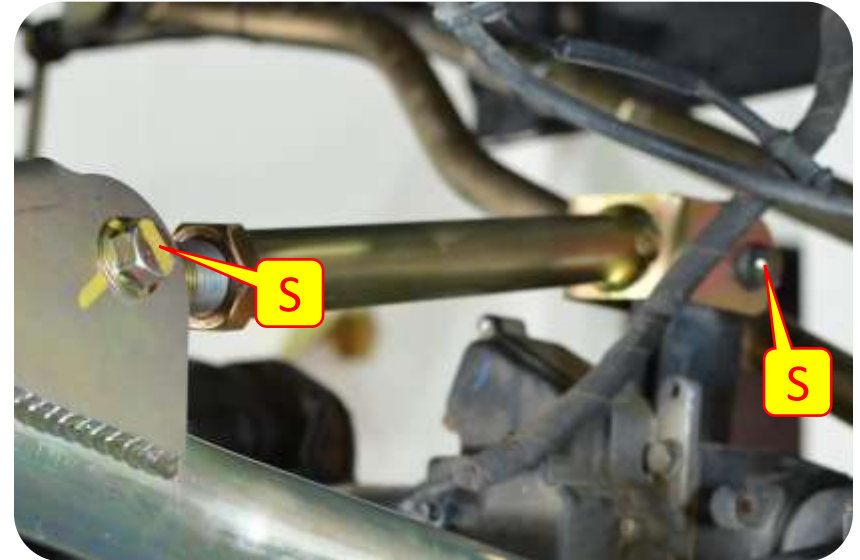





## Section 3: Installation Instructions

### Coil Isolator Information Guide

**Important Note:** MetalCloak's suspension systems include a unique coil design that utilizes upper isolators to position the coil. The following table will help you identify where to install the isolators included with your kit. You must remove the stock isolators before installing the provided coil isolators. If you have any questions give us a call at 916-631-8071.

Coil Isolator Jeep Locations		
Tall Isolator	Jeep Model	Installation Locations
	JL Wrangler 3.6L Non-E Torque	Upper Front Passenger
	JL Wrangler 2.0T E-Torque	Upper Front Driver & Passenger
	JL Wrangler 4xE	Upper Front Driver & Passenger
	JL Wrangler Diesel	Upper Front Driver & Passenger
	JT Gladiator Diesel	Upper Front Driver & Passenger
Short Isolator	Jeep Model	Installation Locations
	JK Wrangler (All Models)	Upper Front Driver & Passenger
	JL Wrangler 3.6L Non-E Torque	Upper Front Driver
	JL Wrangler 3.6L E-Torque	Upper Front Driver & Passenger
	JL Wrangler Turbo	Upper Front Driver & Passenger
	JL Gladiator 3.6L Motor	Upper Front Driver & Passenger
Rear Isolator	Jeep Model	Installation Locations
	JL Wrangler 3.6L Non-E Torque	Upper Rear Passenger
	JL Wrangler 4xE	Upper Front Driver & Passenger

## Section 3: Installation Instructions

### Step 8: Install Coils and Bump Stops

- V. Using a 10mm socket disconnect the bracket from the spring perch on the axle.
- W. Drill out the center hole using a step bit or you can start your hole with a smaller drill bit and work your way up to a 1/2".
- X. Install the front coils. Make sure the tightly wound coils are oriented upward.
- Y. Slip the bottom of the coil onto the coil base on the axle. Rotate the coil until it is seated properly on the coil base.

**Important Note:** Droop your suspension to gain access to the spring perch. Be sure to watch the ABS lines so they do not get over extended and break.

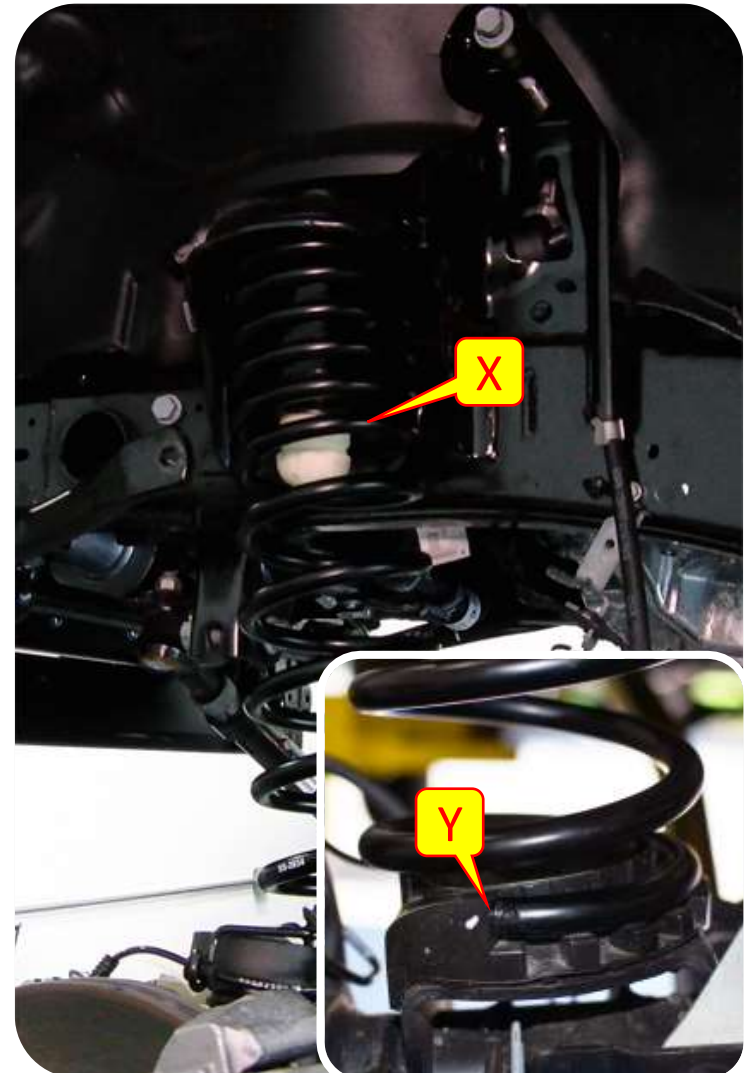
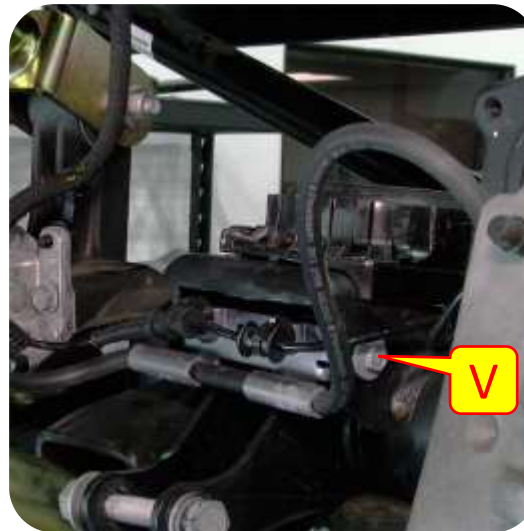

**Important Note:** If the axle does not droop enough to allow the coil to be put in place a coil compressor can be used to compress the coil to allow fitment.

## Section 3: Installation Instructions

### Step 8: Install Coils and Bump Stops

**Important Note:** Your individual build may require an addition or removal of bump stop pucks for your tire size fitment.

Z. Select the appropriate Screw length so that the threads stick out of the bottom Disks approximately  $\frac{3}{4}$ ". Assemble your bump stops inside the installed coil by feeding the  $\frac{1}{2}$ " Countersunk Screw through the Cover Plate, and then threading through the Bump Stop Disks. The center hole in the Disk is intentionally small to create the most rigid assembly possible after installation.

AA. The  $\frac{1}{2}$ " Screw is backed by a  $\frac{1}{2}$ " Flanged Nylon Lock Nut. Install the nut and tighten the hardware using a  $\frac{5}{16}$ " Hex Key Socket or Allen Wrench and a  $\frac{3}{4}$ " Wrench. Tighten until everything is tight; the hardware will not bottom out, but instead will begin to compress the Disks.



## Section 3: Installation Instructions

### Step 9: Install Outboard Shock Spacer & Shocks

BB. Drill out the brake line bracket hole using a 3/8" drill bit or step bit.

CC. Drill out the hole located on the bottom of the stock shock mount using a 3/8" drill bit or step bit.

DD. Place the outboard spacer on the stock shock mount so it aligns with the pre existing holes.

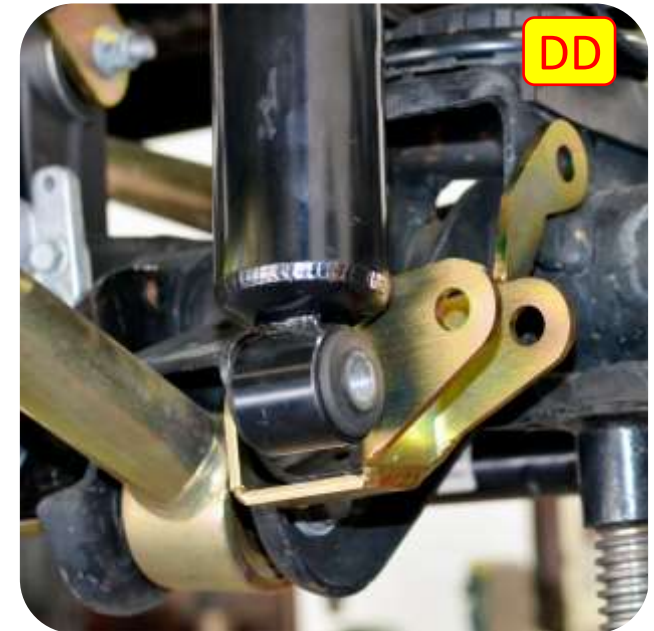
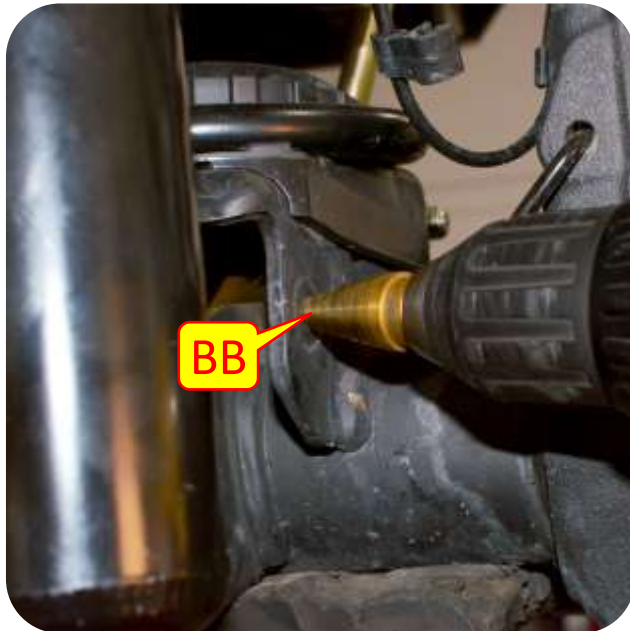

## Section 3: Installation Instructions

### Step 9: Install Outboard Shock Spacer & Shocks

EE. Install the lower shock mount bolt hand tight.

FF. Install the provided bolt and nut into the brake line bracket mount location hand tight.

GG. Install the spacer and stock hardware into the stock location and tighten using a 18mm socket and wrench.

HH. Using a 14mm wrench and socket tighten the two remaining bolts.



## Section 3: Installation Instructions

### Step 10: Install Outboard Shock Spacer & Shocks

- II. Using the stock hardware install the top of the RockSport shock making sure the spacer is on the inboard side of the shock.
- JJ. Align the shock with the outboard shock mount.
- KK. Install the shock with the provided 1/2" bolt and flange lock nut.
- LL. Using a 19mm wrench and socket tighten the 1/2" bolt and flange lock nut.
- MM. Secure the brake line bracket back on to the coil perch with a zip tie.



## Section 3: Installation Instructions



### Step 11: Install Front Track Bar

- NN. Install the front track bar. Making sure the adjustable end of the track bar goes into the stock bracket on the axle. Re use the stock hardware.
- OO. Install the fixed end of the track bar into the stock frame bracket. The clearance bends should point towards the front bumper, up and away from the differential cover. Re use the stock hardware.
- PP. Fully tighten the stock hardware on both ends of the Track Bar using a 21MM socket and wrench, and then tighten the Jam Nut on the Track Bar.
- QQ. MetalCloak **STRONGLY RECOMMENDS** having your alignment checked by a professional after changing any suspension components.

**Note:** *It is helpful to have someone push the vehicle to the driver or passenger side to help align the hole; if you don't have an extra pair of hands you can use a ratchet strap on the frame/axle to pull the frame in the desired direction. Lower the Jeep to the ground to ensure the axle is centered once the bolt is in place. If not then remove the bolt, adjust the Track Bar length, replace the bolt, and re-check axle centeredness. Repeat until the axle is as close to center.*



## Section 3: Installation Instructions

### Step 11: Install Front Track Bar

**Note:** MetalCloak uses an over-sized forged housing for additional strength; the factory window pocket may need additional clearance for optimal fitment. Use a die grinder and cutting bit to enlarge the existing window in the factory track bar bracket.

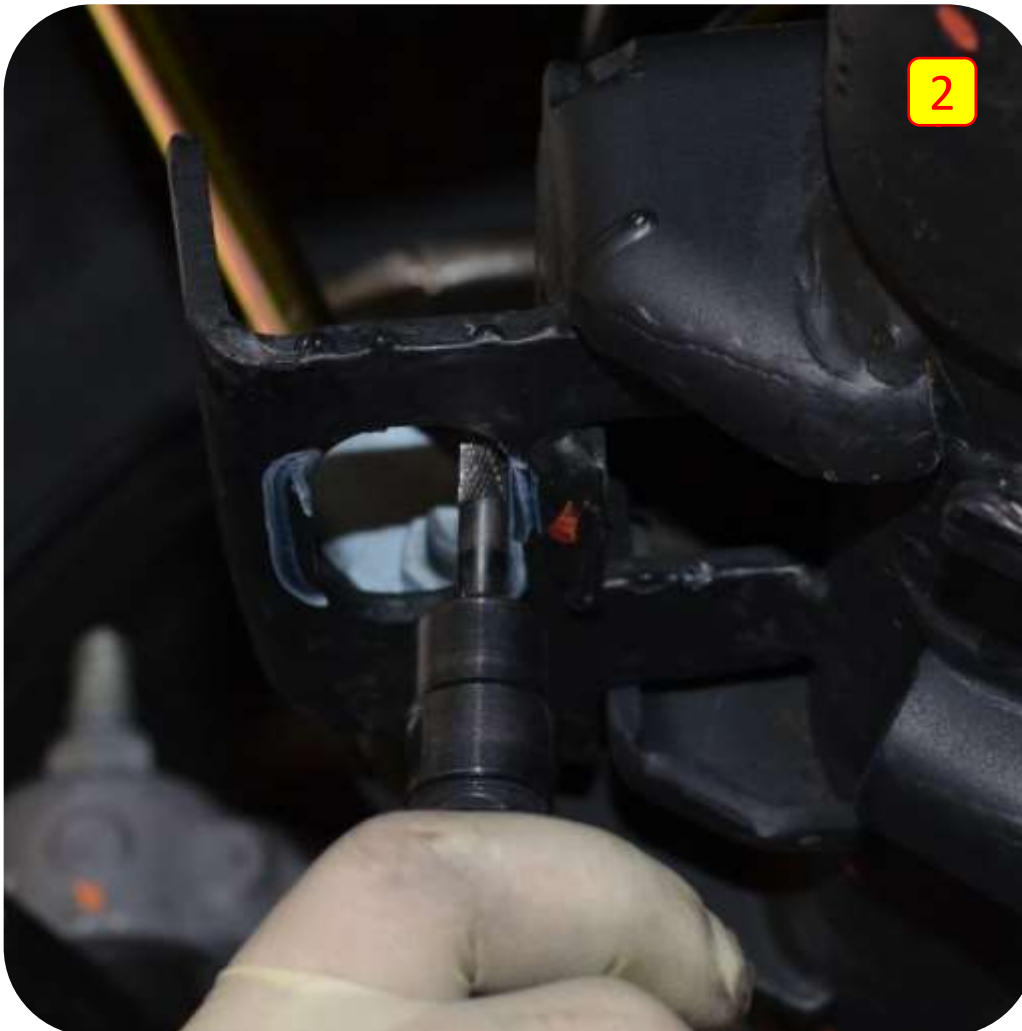



## Section 3: Installation Instructions



### Step 12: Install Sway Bar End Links

- RR. Using the factory hardware install the bottom of the MetalCloak extended sway bar links.
- SS. Using the supplied hardware install the top of the MetalCloak extended sway bar links
- TT. Tighten sway bar end links with an 18MM Wrench for the factory hardware and a 3/4" & 18MM wrench for the supplied hardware.

**Important Note:** MetalCloak recommends using red Loctite on each of the upper spindles of the sway bar end links.

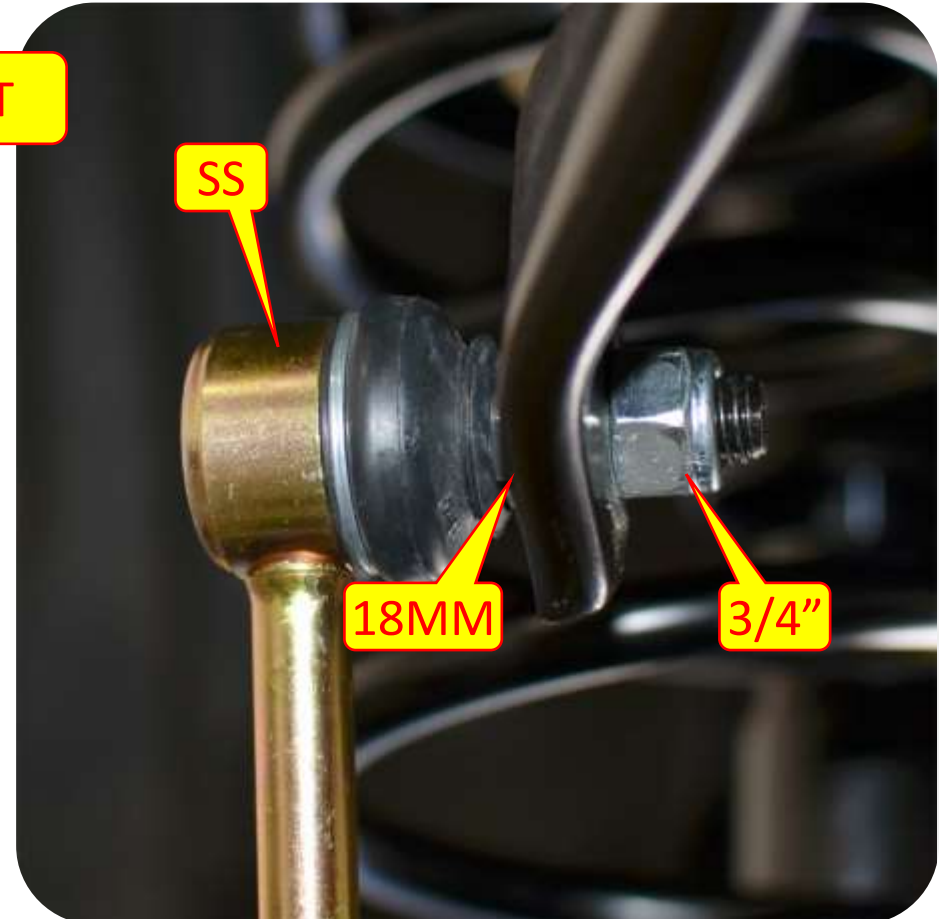
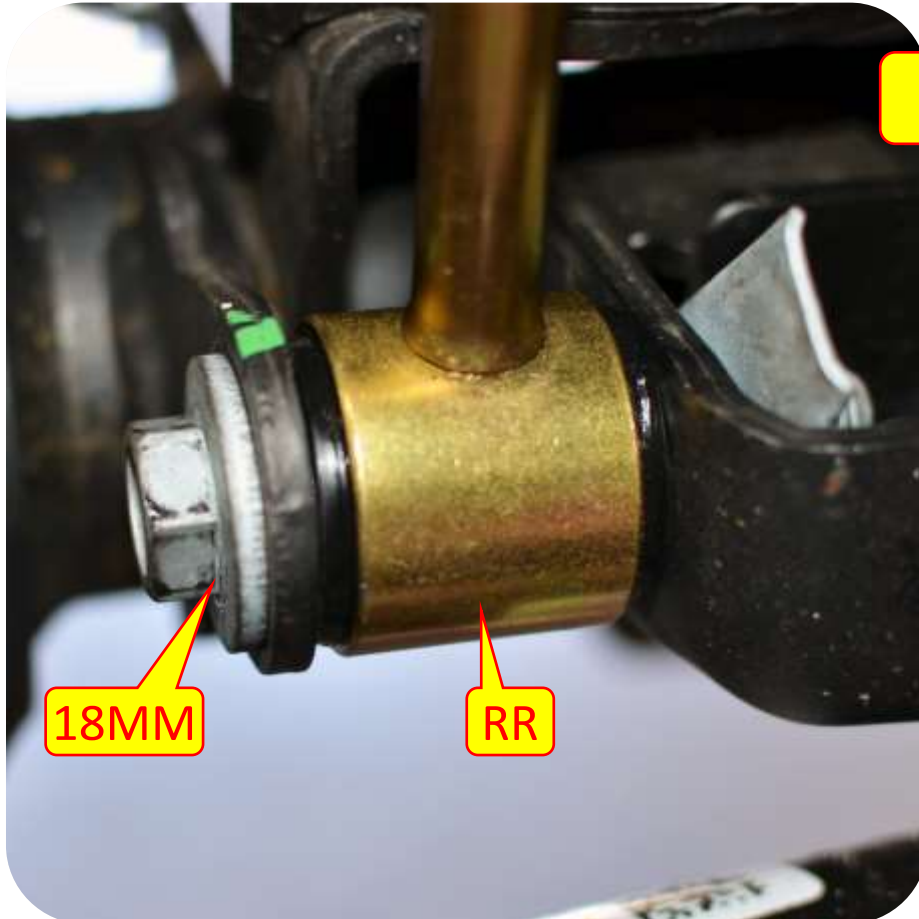

## Section 3: Installation Instructions



### Step 13: Finalize Installation

UU. Adjust the caster angle and toe as needed. Once set, tighten all hardware, Re attach all brackets and reinstall the heat shield. Finally, tighten the jam nuts on all control arms.

**Note:** When lifting any vehicle, basic dynamics are changed. It is important to take your vehicle to a professional for an alignment after installation. Make sure caster setting is adjusted for a lifted vehicle (not stock specs).

## Section 3: Installation Instructions



### Step 1: Remove Stock Components

**Important Note:** MetalCloak Recommends removing the bottom rear fender well plate for easier access to the upper shock bolts by using a 8MM socket wrench.



## Section 3: Installation Instructions

### Step 1: Remove Stock Components

- A. Using a 21mm socket and wrench disconnect the stock shocks. **Save all hardware.**
- B. Disconnect the locker, breath tube, and wheel speed sensor lines, and emergency brake bracket from the axle.
- C. Disconnect the rear sway bar links using an 18MM wrench. **Save all hardware.**
- D. Using a 21MM Socket and wrench disconnect the stock rear track bar. **Save all Hardware.**
- E. Remove Stock Coils.

**Important Note:** Make sure the axle is supported before disconnecting anything.

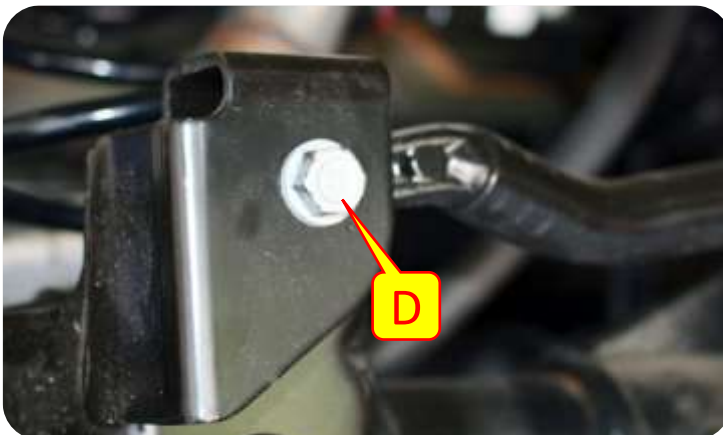
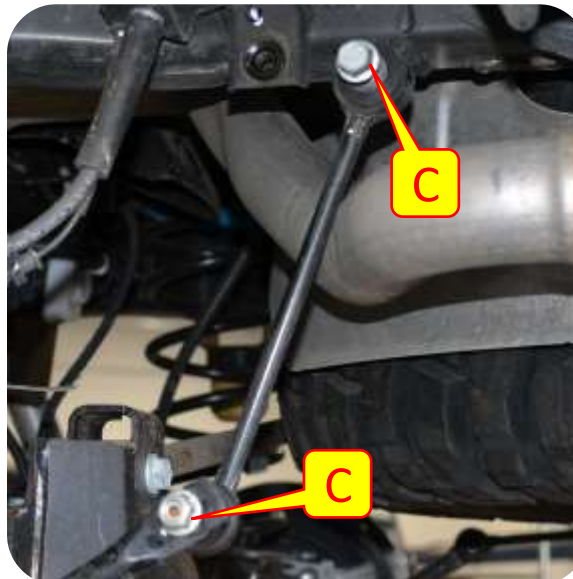
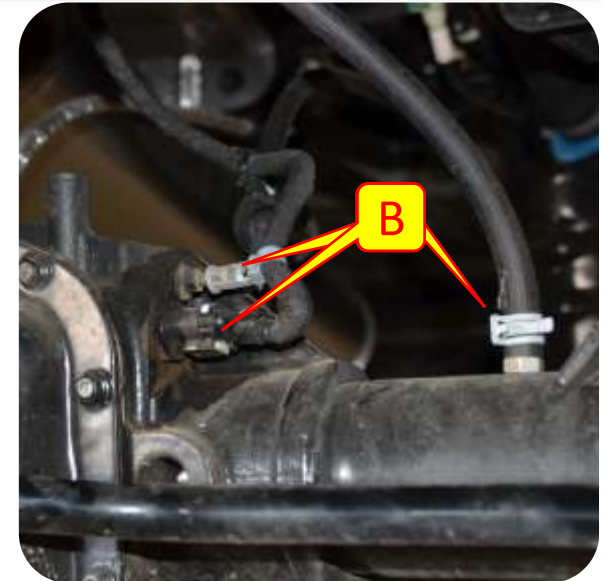
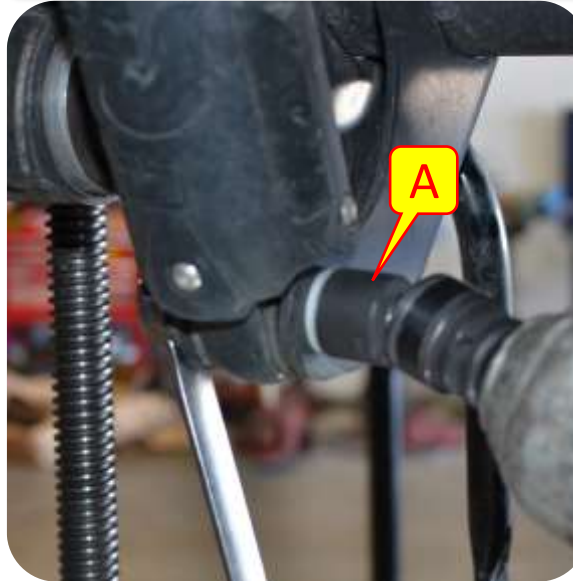

## Section 3: Installation Instructions

### Step 1: Remove Stock Components

- F. Remove the factory control arm bolts of the rear upper and lower control arms with a 23mm socket and 21mm wrench.
- G. Disconnect the E-Brake cable at the wheel end.

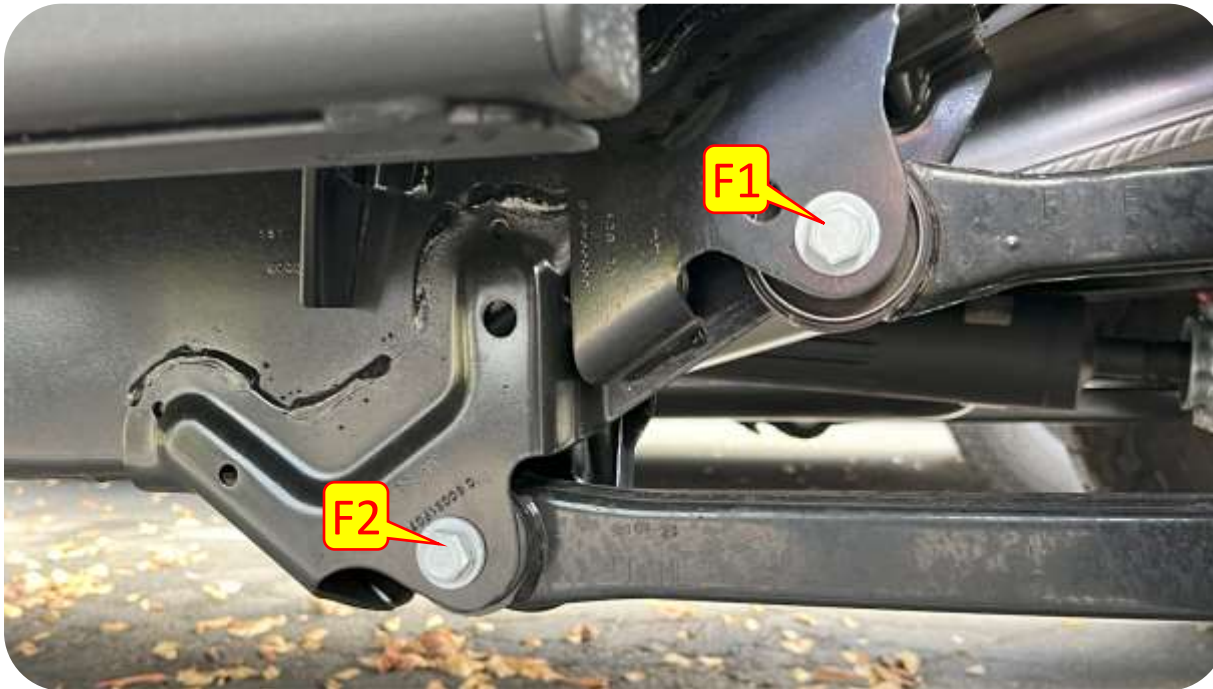

## Section 3: Installation Instructions



### Step 2: Gas Tank Removal

**Important Note:** *It is required to cut off the factory rear control arm mounts at the frame for this installation. MetalCloak recommends removing the gas tank for optimal safety when removing this bracket; if you are uncomfortable removing the tank you should take your Jeep to an Authorized MetalCloak installer to have the work done by a professional.*

**Important Note:** *After removing the factory control arm mount MetalCloak recommends grinding the area smooth, clean, and then paint any of the exposed metal to help prevent rust.*

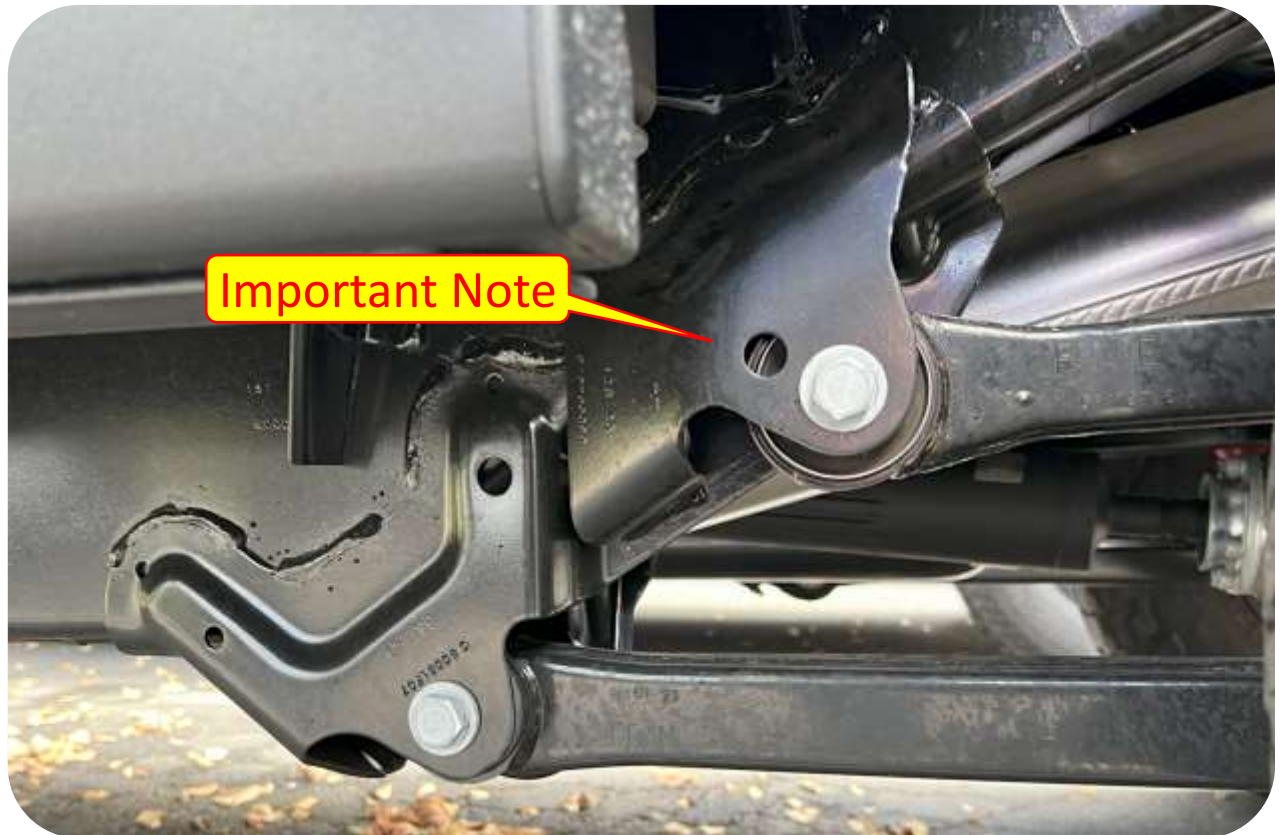

## Section 3: Installation Instructions

### Step 3: Rear Frame Bracket Installation

- H. Align the bracket with the frame making sure that the 2 holes on the bottom of the frame are centered and front most 2 holes on the frame are centered with the holes on the bracket.
- I. Secure the Mounting Bracket to the frame using a clamp or an assistant.
- J. Center mark your rear most side hole drill with a 1/2" drill bit.

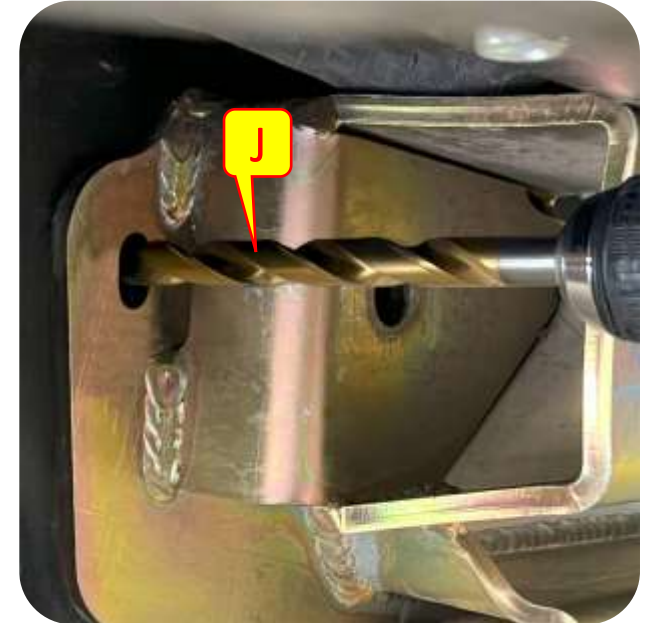
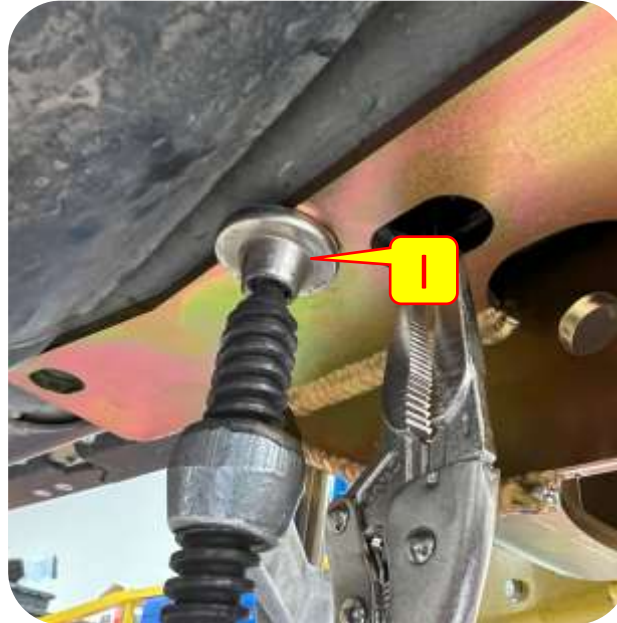
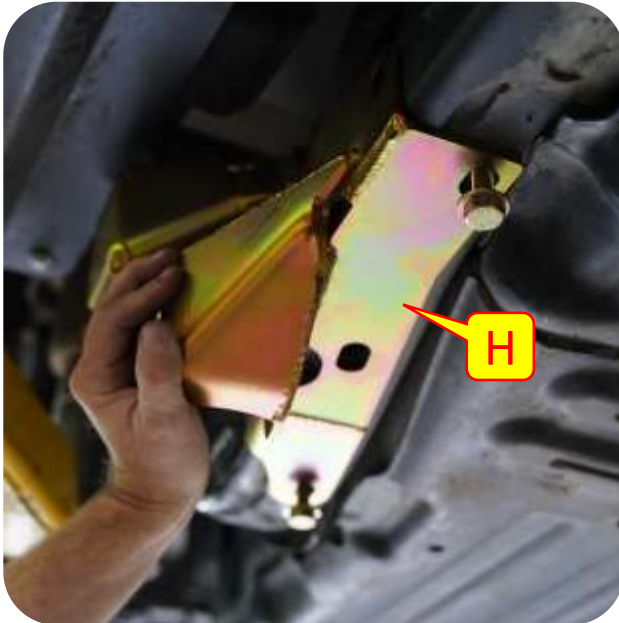

## Section 3: Installation Instructions

### Step 3: Rear Frame Bracket Install (Driver Side Gas JT / Passenger Side Diesel JT)

- K. Most JT will only have threaded inserts on the fuel tank side only (*Passenger Side on a Gas JT and Driver side on the Diesel*). When installing the bracket on the side opposite to the fuel tank you must use flag nuts JTF and JTR. Insert JTR through the hole in the side of the frame bolt end 1st (*K1*) and use your finger and a screwdriver to slide the flag nut down the frame to the rear most hole. The tail of this flag nut should fall through the slot in the bottom of the frame. (*K3*) next Install JTF through the same hole but this time inset it tail first. slid the nut to be over the front most hole in the bottom of the frame and again the tail of the flag nut should fall through the slot in the bottom of the frame. Optionally on some vehicle JTF and JTR can be installed through the slot in the bottom if the slot is large enough (*K2*). Use vice grips to hold each flag nut tail, install a 1/2 bolt into each flag nut from below (*L*).

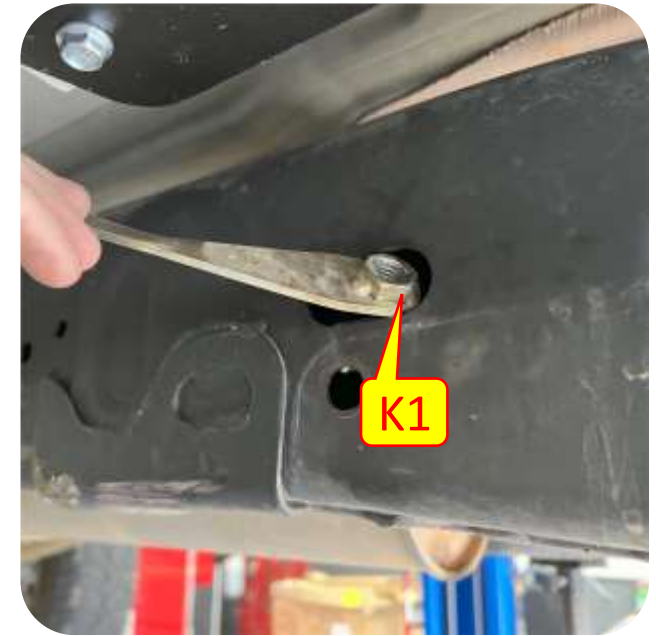



## Section 3: Installation Instructions

### Step 3: Rear Frame Bracket Install (Gas Tank Side)

- M. Insert the long flag nut labeled JTS through the access hole (*M1*) to the drilled-out bolt hole (*M2*). Install 1/2" bolt into flag nut and hand tighten. After bolt is started into flag nut, you may push the tail into the frame to not obstruct the installation of remaining 2 flag nuts.
- N. Insert the flag nut labeled JT through the access hole (*N1*) to the center bolt hole on the bracket (*N2*). Install 1/2" bolt into flag nut hand tight.

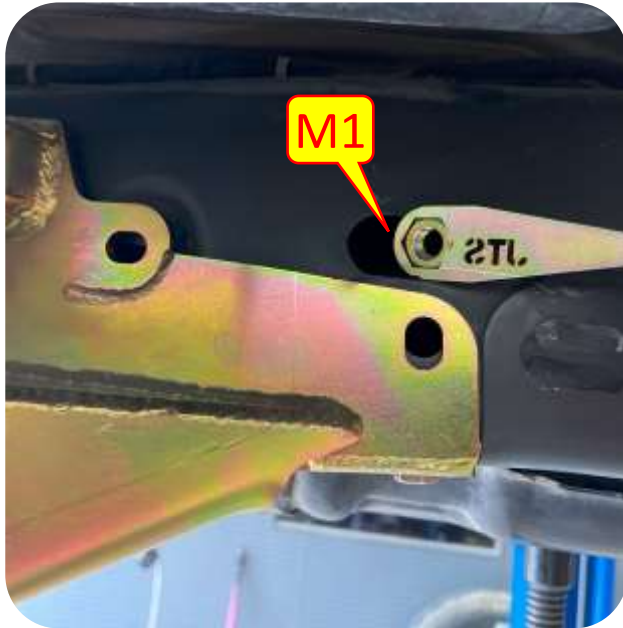

## Section 3: Installation Instructions

### Step 3: Rear Frame Bracket Install (Gas Tank Side)

- O. Insert the smallest flag nut through the access hole to the front hole just under the access hole and install 1/2" bolt into flag nut hand tight.
- P. Fully tighten all 1/2" bolts using a 3/4" socket and all M12 bolts (*bottom bolts*) using a 19mm socket.

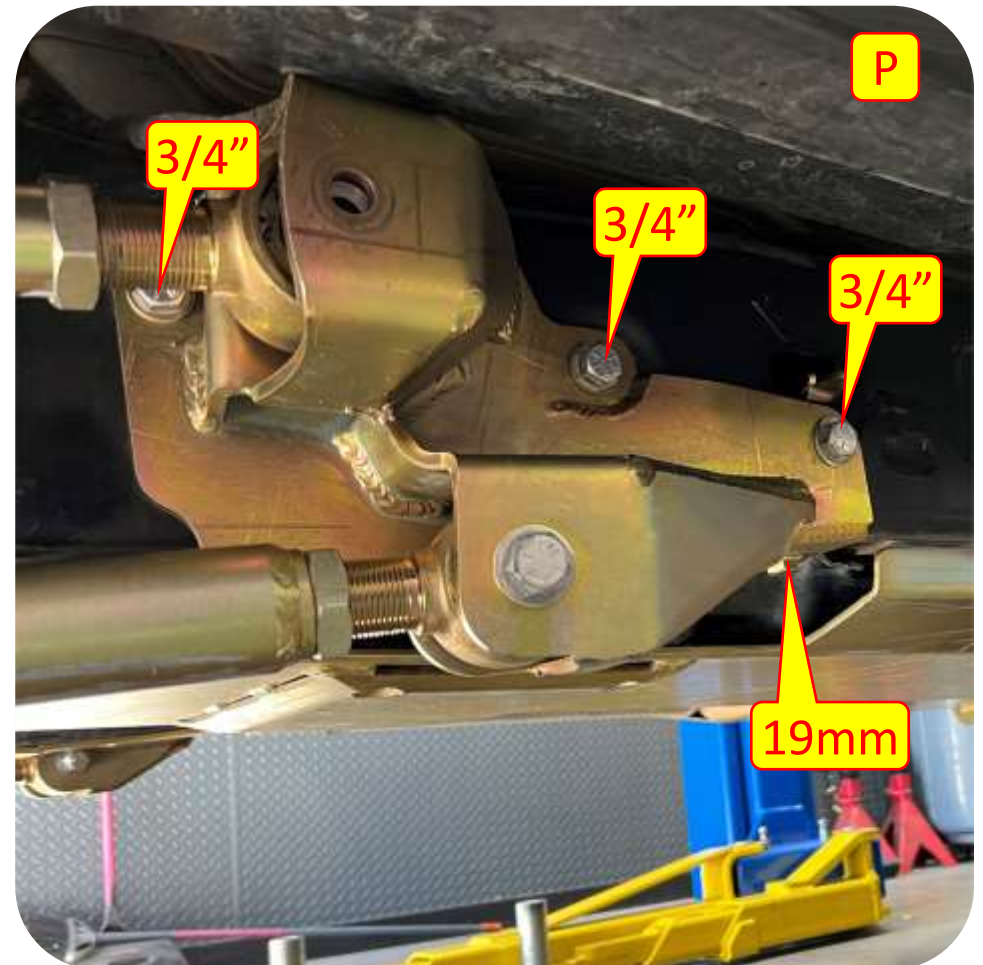

## Section 3: Installation Instructions

### Step 4: Axle Control Arm Correction Bracket Installation

- Q. Feed the E-Brake cable through the holes on the bracket and set the bracket into place with the bracket offset to the outside of the vehicle.
- R. Insert the crush sleeve into factory upper control arm mount and insert the provided 5/8" bolt and nut hand tight.
- S. Set lower arms to 37 1/2" as a starting point eye to eye and install using the provided 5/8" bolts and nuts making sure the lock nuts are at the frame.
- T. Set upper arms to 33 1/2" as a starting point eye to eye and install using the provided 5/8" bolts and nuts making sure the lock nuts are at the frame.

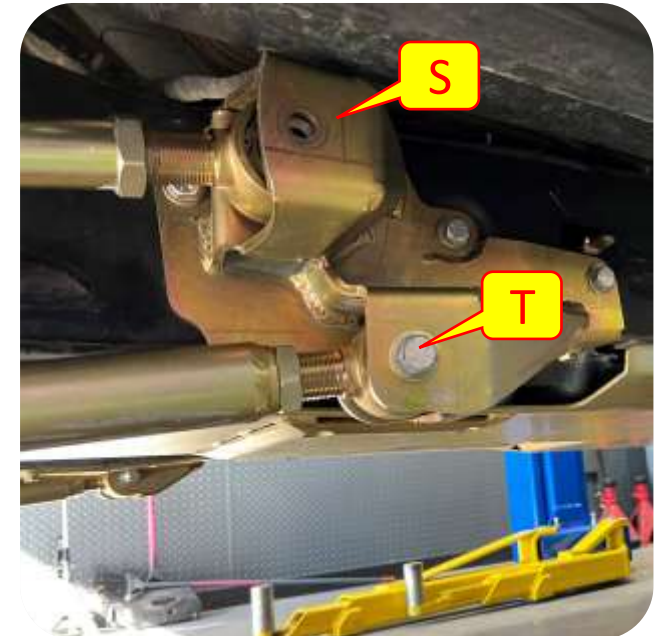
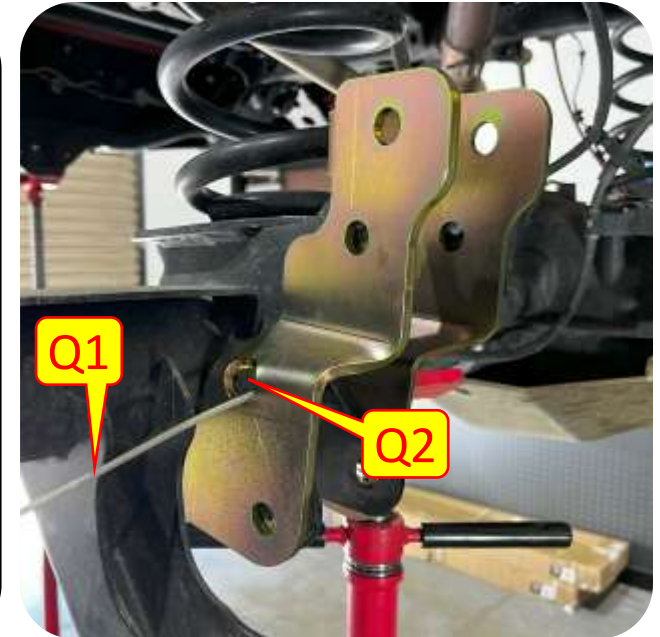

## Section 3: Installation Instructions

### Step 4: Axle Control Arm Correction Bracket Installation

- U. Working from the bottom to the top tighten the correction bracket bolts with a 15/16" socket and wrench.
- V. Reinstall the E-Brake.

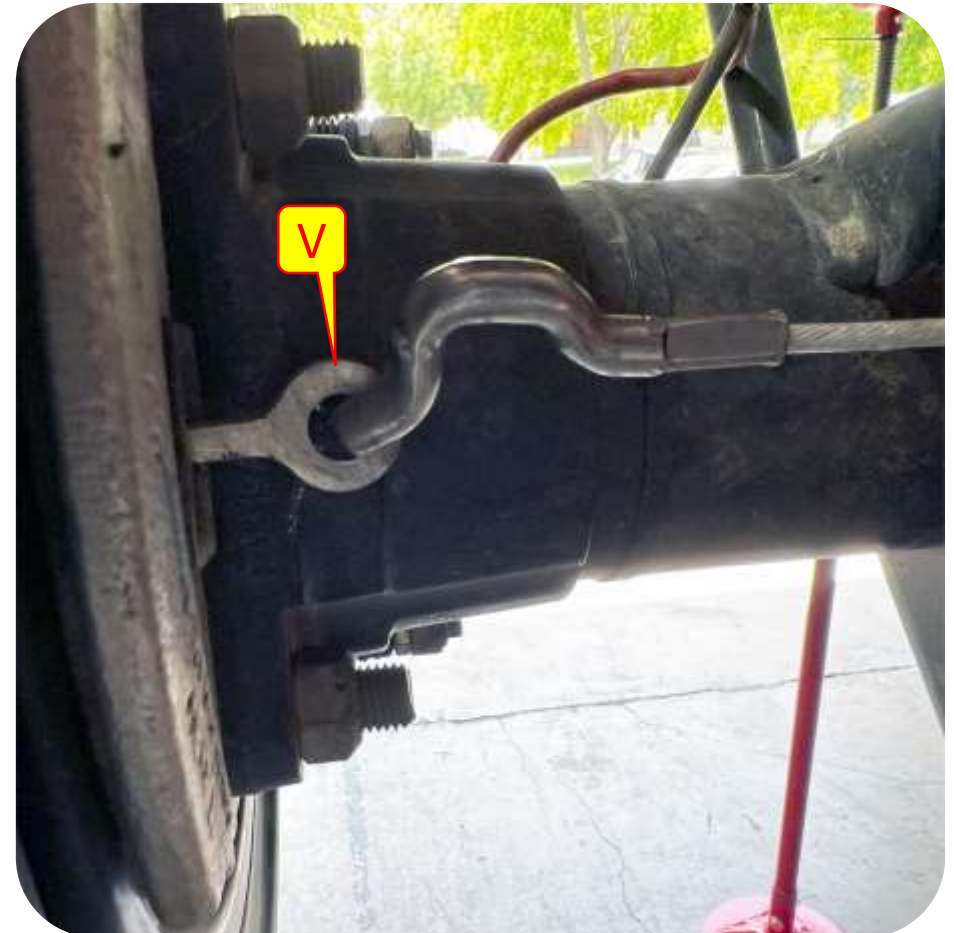
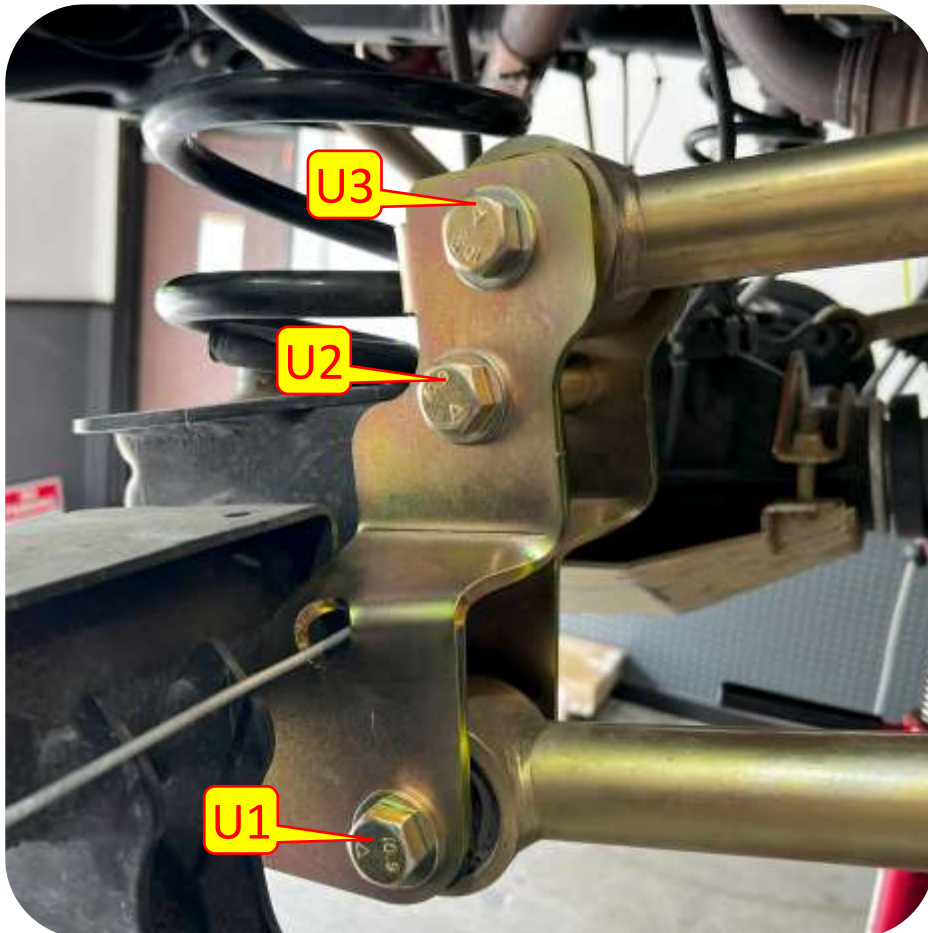

## Section 3: Installation Instructions

### Step 5: Install Rear Coils

- W. If the axle does not “droop” enough to allow the coil to be put in place a coil compressor can be used to compress the coil to allow fitment.
- X. Place the rear coil cup on top of the rear true dual rate coil.
- Y. Install rear true dual rate coils with the tightly wound coils oriented upward.
- Z. Slip the bottom of the coil onto the coil base on the axle.
- AA. Install the RockSport shocks in the stock locations using the stock hardware.



## Section 3: Installation Instructions



### Step 6: Install MetalCloak Track Bar

- K. Install the MetalCloak Track Bar using the stock hardware. You may need to lower the vehicle to the ground to install one end of the track bar and tighten the hardware using a 21MM Socket and Wrench.



## Section 3: Installation Instructions



### Step 7: Sway Bar Links

CC. Using an 18mm socket Install the extended sway bar end links to the frame and on the sway bar.

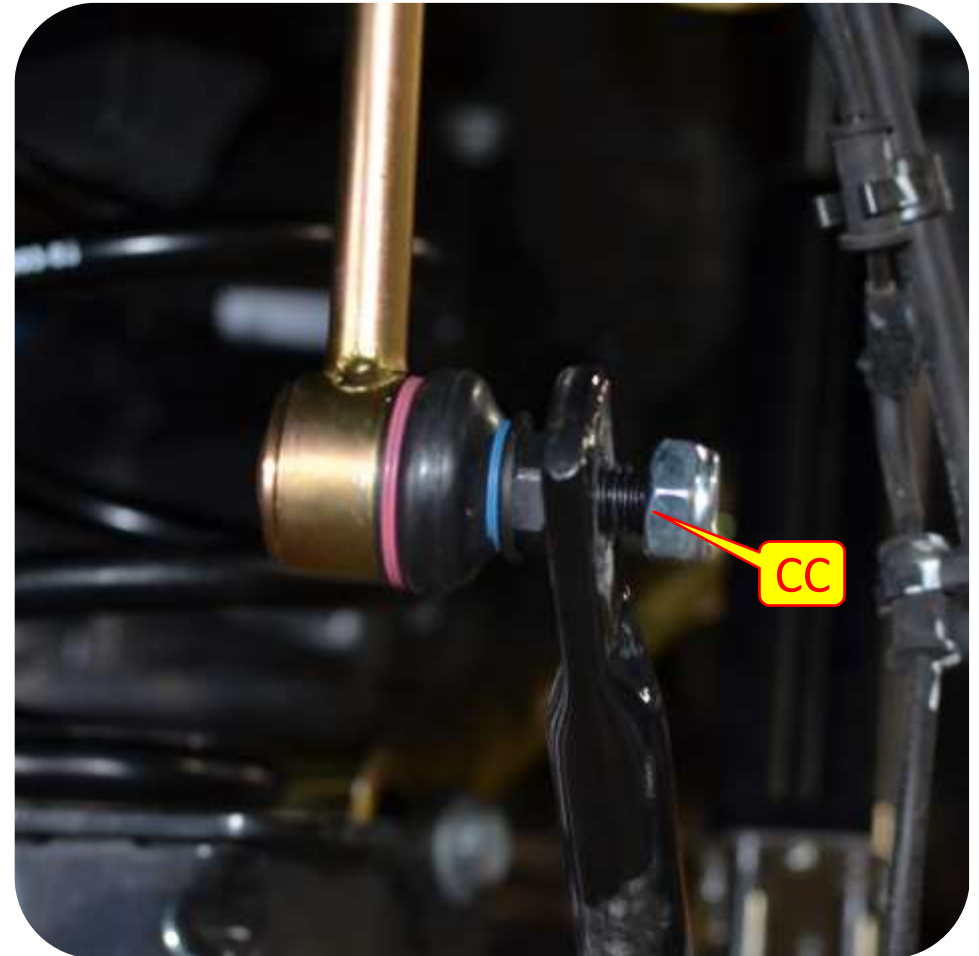

## Section 3: Installation Instructions

### Step 8: Install Rear Bump Stops

DD. Center the rear bump stop onto the rear axle bump stop plate and mark the holes in preparation for drilling.

EE. Center punch the marked holes.

FF. Drill a pilot hole at the marked location and work your way up to a 3/8" drill bit.

GG. Using a 1/2" wrench and a 3/16" allen socket tighten the provided hardware into the drilled locations.





## Section 3: Installation Instructions

### Step 9: Install Rear Bump Stops

HH. Install next puck (Side B) using the 1 3/4" woodscrews.

II. Continue until desired bump stop height (Side A/Side B/ Side A/Side B).

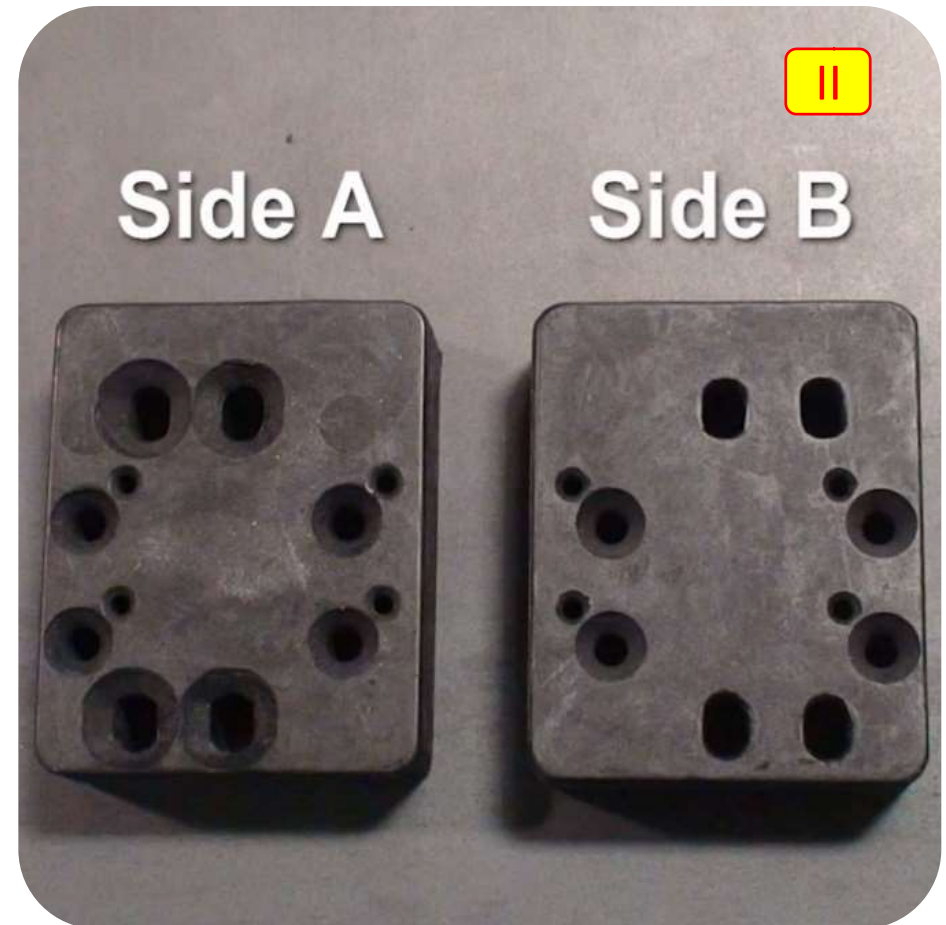

## Section 3: Installation Instructions

### Step 10: Rear Brake Line Installation

**Important Note:** MetalCloak recommends placing a drain pan under the caliper; fluid will leak out when removing brake lines.

JJ. Carefully disconnect the brake line from the ABS line.

KK. Using pliers remove the stock brake line spring clip.

LL. Using a 12mm and 16mm wrench disconnect the stock brake line at the frame.

MM. Using a 15mm wrench disconnect the brake line from the caliper. **Save bolt.**

**Note:** Make sure the copper washer is removed from the caliper.

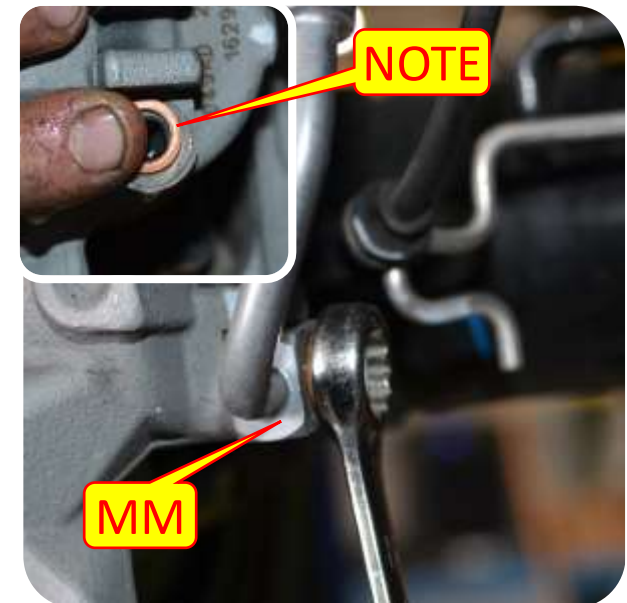

## Section 3: Installation Instructions

### Step 11: Rear Brake Line Installation

NN. Install the new brake line into the caliper using the stock bolt making sure to place a brass washer on each side of the brake line.

OO. Install the break line at the frame and install the provided spring clip.

PP. Using a 12mm and 18mm wrench fully tighten the brake line at the frame.

QQ. Using a 15mm wrench fully tighten the brake line at the caliper.

RR. Using zip ties reconnect the Brake Line to the ABS Line.

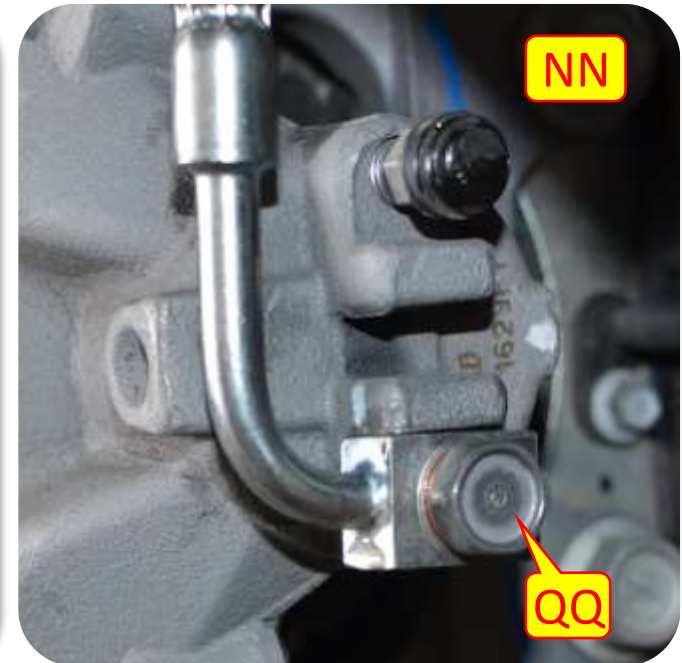

## Section 3: Installation Instructions



### Step 12: Finalize

- SS. Lower the vehicle to the ground and re connect the locker, breath tube, and wheel speed sensor lines, and emergency brake bracket to the axle.
- TT. Adjust the caster angle and toe as needed.
- UU. Once the caster is set, make sure to tighten all hardware and tighten the jam nuts on all control arms.

## Section 3: Installation Instructions



### Step 13: Bleed Brakes

**CAUTION!! FAILURE TO PROPERLY BLEED THE BRAKE LINES WILL CAUSE YOUR BRAKES TO BE INEFFECTIVE.**

Before your vehicle is ready to drive you will need to refill the brake reservoir and bleed the air out of the brake lines. If you are not experienced with this process, or have any reservations, consult a professional. For a full write-up of the brake bleeding process for your JEEP Wrangler JK, you can also refer to:

<https://wayalife.com/showthread.php/4335-MAINTENANCE-Bleeding-the-Brakes-on-a-Jeep-JK-Wrangler>

