



PRODUCT: JL Game Changer Suspension, No Shock

REV: D | 03-21-2024 | II-A4435-A4445

READ INSTRUCTIONS IN FULL BEFORE INSTALLATION.

QUESTIONS? CALL 916-631-8071 M-F 7:00 AM – 5:00 PM PST

The MetalCloak experience includes the ease of installation of our products. We design for most contingencies, but installation may be different based on different Jeep condition, configuration and/or year.

We are continually trying to improve our products and instructions – please help us by providing feedback and pictures if you find any part of the instructions that do not match your particular Jeep or are not easily understandable.

If you have any difficulties at all, please give us a call. Thank you and enjoy your MetalCloak Products!

WARRANTY INFORMATION: This article is sold without warranty expressed or implied. No warranty or representation is made as to this products ability to protect the user from injury or death. The user assumes that risk. The effectiveness, warranty and longevity of this equipment are directly related to the manner in which it is INSTALLED, USED and/or MAINTAINED. THE USER ASSUMES ALL RISK. By purchasing this product and opening the packaging, purchasers expressly acknowledge, understand and agree that they take, select and purchase these MetalCloak products from Armored Works, LLC, its affiliates and distributors and agents as is and with all faults. The entire risk as to the quality and performance of these MetalCloak products is with the purchaser. Working on your vehicle can be a dangerous activity. If you are unsure of what you are doing, please leave mechanical or safety critical work to a skilled mechanic. We take no responsibility for the incorrect use and/or installation of MetalCloak products.

Section 1: Tools & Notes on Installation



Tools Required: This list is the recommended tools for ease of installation. Other versions of the same tool can be used. For example, Allen Wrenches instead of Allen Drive Sockets. Be sure to use metric on metric and SAE on SAE.



Socket & Ratchet Wrench
10" Socket Extension

7MM, 10MM, 13MM Sockets
18MM, 21MM, 24MM Sockets
9/16" , 13/16" , 15/16" Sockets
3/4" , 1 1/8" Socket



Metal Head Hammer

Metric Hex Sockets
and/or Hex (Allen) Wrenches



Tape Measure

3/8" Flare Nut Wrench (10mm will
work) for Brake Lines



Cut-Off Disc and Grinder

Drill
Drill Bits (1/8" up to 1/2")
Center Punch



HOW TO USE THIS GUIDE: The installation guide contains ALL steps for installation. Please read and follow the instructions in order of each page top to bottom, and left to right.

Jeep Model: Instructions may apply to multiple Jeep models, but are labeled separately where appropriate (i.e. TJ vs. LJ).

Options: Because of the number of component options we offer, these instructions may contain steps that will not match your particular configuration. You can skip these steps.

Images: Pictures are provided and parts are labeled throughout the instructions. Each text box contains guidance based on the pictures next to it. The text will refer to alphabetical labels (A, B, etc.) found in the images.

Installation Notes: Terms may be used in the body of the instructions that you may not be familiar with, if you have any questions feel free to contact us at the number below, or email techhelp@metalcloak.com

QUESTIONS: Any questions or comments about the instructions? Call us at 916-631-8071 M-F 7:00 AM – 5:00 PM PST.

Section 2: Product Components

DC-0001 Rev B

SHEET 1 OF 1

ITEM	PART NUMBER/DESCRIPTION	QTY.
1	7040 BUMP STOP KIT, 1.0-4.0 JK FRONT	1
2	7043 BUMP STOP KIT, 1.0-4.0 REAR	1
E 3	7277 OFFSET SWAY BAR LINK KIT, 12IN, JL REAR	1
4	7288 BOLT ON 4 LINK FRONT SYSTEM, JLU JT	1
5	7642 TRACK BARS, JL FRONT+REAR	1

OPTIONS:

1) SHOCKS:		
NO SHOCKS	(A5902)	
OUTBOARD SHOCKS, JL	(A5100)	
STOCK SHOCKS	(A5103)	
ROCKSPORT SHOCKS JL	(A5101)	
6PAK SHOCK JL	(A5102)	
2) ENGINE:		
4DR DIESEL	(7665-D)	
4DR 3.6L GAS	(7665-G)	
4DR TURBO/3.6L E-TORQUE	(7665-T)	
3) JEEP MODEL		
RUBICON SWAYBAR LINKS	(7015)	
NON-RUBICON QD-LINKS	(7614)	
4) REAR ARM SECECTION:		
REAR BOLT ON LONG ARM	(7289)	
DB3 ARM KIT	(7260)	

THE INFORMATION CONTAINED ON THIS DRAWING IS THE EXCLUSIVE PROPERTY OF ARMORED WORKS, LLC. UNAUTHORIZED REPRODUCTION IS PROHIBITED.
DO NOT SCALE DRAWING

MetalCloak
A DIVISION OF ARMORED WORKS, LLC

PART NUMBER/DESCRIPTION
A4435 JL WRANGLER LONG ARM 4-LINK 3.5

Section 2: Product Components

DC-0001 Rev B

SHEET 1 OF 2

	1	2	3	4	5	6	7	8	
ITEM.	PART NUMBER / DISCRIPTION						QTY.		
E	1	SS-0325 BACKING PLATE, LONG-ARM MOUNT LOWER, FRONT JL JT					1		
	2	WM-5897 WELDMENT, FLAG NUT .5-13, LOWER LONG-ARM MOUNT JL JT					2		
	3	WM-5898 WELDMENT, FLAG NUT 5-13, LONG ARM MOUNT JL JT					2		
	4	WM-5954 WELDMENT, LONG-ARM MOUNT LOWER, FRONT JL JT					1		
	5	WM-5954-P WELDMENT, LONG-ARM MOUNT LOWER, FRONT JL JT					1		
	HK-7295								
D	6	FS-08173 HHCS, 0.5-13 x 1.75L STL G8 ZINC FULL THREAD					4		
	7	FS-08307 WASHER, 0.53ID X 1.06OD X 0.20TH STL GR8 GOLD ZINC					12		
	8	FS-08322 HHCS, 0.50-13 x 4.50L STL G8 GOLD ZINC					4		
	9	FS-08359 TOPLOCK NUT, 0.5-13 X .44H STL GC STL ZINC					4		
	10	FS-10130 TOPLOCK NUT, 0.63-18 X 0.55H STL GC CAD					2		
	11	FS-10161 WASHER, 0.66ID X 1.31OD X 0.14TH STL GR8 GOLD ZINC					4		
	12	FS-10295 HHCS, 0.63-18 X 4.25L STL G8 ZINC					2		

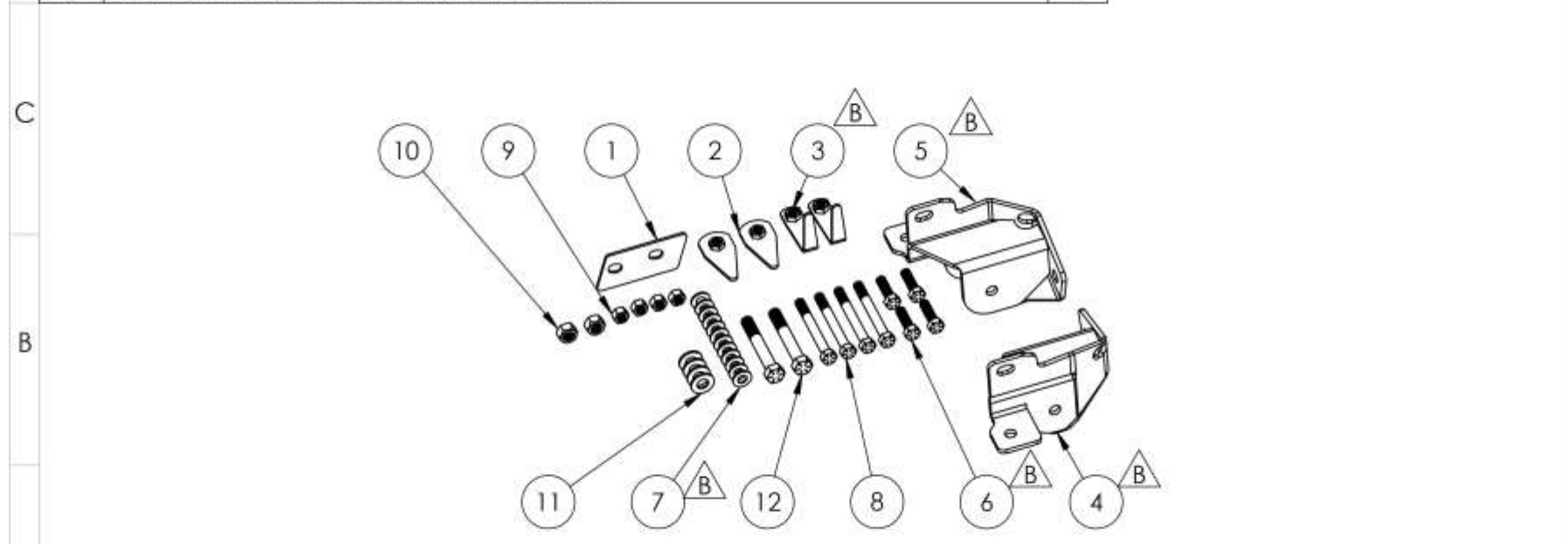

THE INFORMATION CONTAINED ON THIS DRAWING IS THE EXCLUSIVE PROPERTY OF ARMORED WORKS, LLC. UNAUTHORIZED REPRODUCTION IS PROHIBITED.

DO NOT SCALE DRAWING

Metal Cloak

A DIVISION OF ARMORED WORKS, LLC

PART NUMBER/DESCRIPTION

7295 LONG ARM MOUNT LOWER, FRONT JL-JT

Section 2: Product Components

DC-0001 Rev B

SHEET 1 OF 2

ITEM.	PART NUMBER	QTY.
1	WM-5885 WELDMENT, .5-13 FLAG NUT	2
2	WM-5896 WELDMENT, FLAG NUT .5-20, 4-LINK MOUNT JK JL	2
3	WM-5901 WELDMENT, FRONT NUT PLATE, 4-LINK MOUNT JL JT	1
4	WM-5901-P WELDMENT, FRONT NUT PLATE, 4-LINK MOUNT JL JT	1
5	WM-5955 WELDMENT, 4-LINK MOUNT UPPER, FRONT JL JT	1
6	WM-5955-P WELDMENT, 4-LINK MOUNT UPPER, FRONT JL JT	1
7	WM-5958 WELDMENT, LONG FLAG NUT 5-13, LONG ARM MOUNT JL JT	2
HK-7298		
8	FS-08173 HHCS, 0.5-13 x 1.75L STL G8 ZINC FULL THREAD	8
9	FS-08307 WASHER, 0.53ID X 1.06OD X 0.20TH STL GR8 GOLD ZINC	12
10	FS-08311 HHCS, 0.5-20 x 3.00L STL G8 ZINC	2
11	FM-12350 HHCS, M12-1.5 X 35L STL C10.9 GOLD ZINC	2

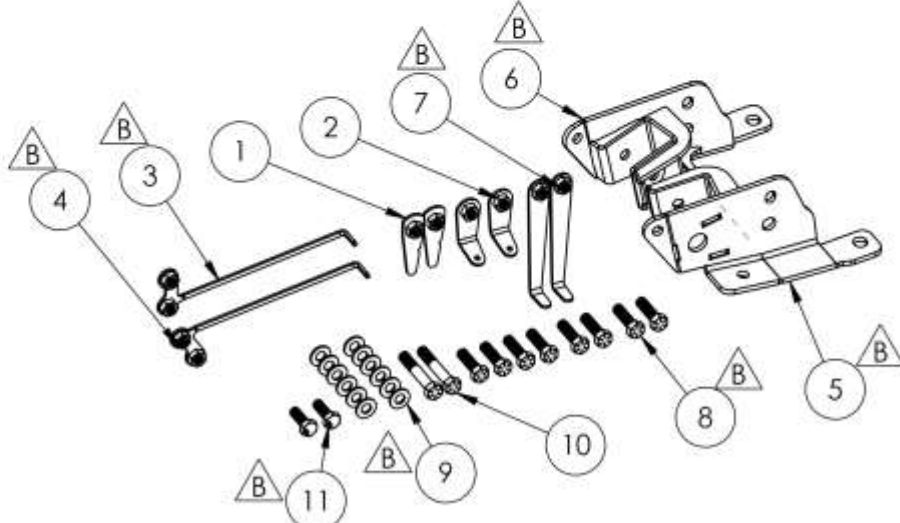

THE INFORMATION CONTAINED ON THIS DRAWING IS THE EXCLUSIVE PROPERTY OF ARMORED WORKS, LLC. UNAUTHORIZED REPRODUCTION IS PROHIBITED.
DO NOT SCALE DRAWING

Metal Cloak
 A DIVISION OF ARMORED WORKS, LLC

PART NUMBER/DESCRIPTION 7298 4-LINK MOUNT UPPER, FRONT JL JT

Section 2: Product Components

ITEM NO.	PART NUMBER	QTY.
1	SS-0289 SIDE SHIM PLATE, 4-LINK MOUNT, REAR JK-JL	1
2	SS-0289-P SIDE SHIM PLATE, 4-LINK MOUNT, REAR JK-JL	1
3	SS-0290 BOTTOM SHIM PLATE, 4-LINK MOUNT, REAR JK-JL	2
4	SS-0312 THREADED FRAME INSERT, 4-LINK MOUNT, REAR JL	2
5	WM-5890 WELDMENT, 4-LINK MOUNT, REAR JK-JL	1
6	WM-5890-P WELDMENT, 4-LINK MOUNT, REAR JK-JL	1
7	WM-5950 WELDMENT, SIDE STICK NUT, 4-LINK MOUNT JL	2
8	WM-5951 WELDMENT, BOTTOM STICK NUT, 4-LINK MOUNT JL	2
9	WM-5956 WELDMENT, LARGE FRAME PLATE, 4-LINK MOUNT REAR JL	1
10	WM-5956-P WELDMENT, LARGE FRAME PLATE, 4-LINK MOUNT REAR JL	1
11	WM-5957 WELDMENT, SMALL FRAME PLATE, 4-LINK MOUNT, REAR JL	1
12	WM-5957-P WELDMENT, SMALL FRAME PLATE, 4-LINK MOUNT, REAR JL	1
HK-7299		
13	FM-12350 HHCS, M12-1.5 X 35L STL C10.9 GOLD ZINC	2
14	FS-06015 HHCS, 0.38-16 x 1.5L STL G8 ZINC, FULL THREAD	4
15	FS-06142 WASHER, 0.41ID X 1.0OD X 0.09TH STL ZINC	4
16	FS-08083 SFHCS, 0.5-13 X 1.00L STL G8 ZINC	2
17	FS-08173 HHCS, 0.5-13 x 1.75L STL G8 ZINC FULL THREAD	8
18	FS-08307 WASHER, 0.53ID X 1.06OD X 0.20TH STL GR8 GOLD ZINC	10
19	FS-09119 WASHER, 0.59ID X 1.16OD X 0.10TH STL GOLD ZINC	8
20	FS-09305 TOPLOCK NUT, 0.56-18 X .48H STL GC STL ZINC	4
21	FS-09313 HHCS, 0.56-18 X 4.0L STL GOLD ZINC	4

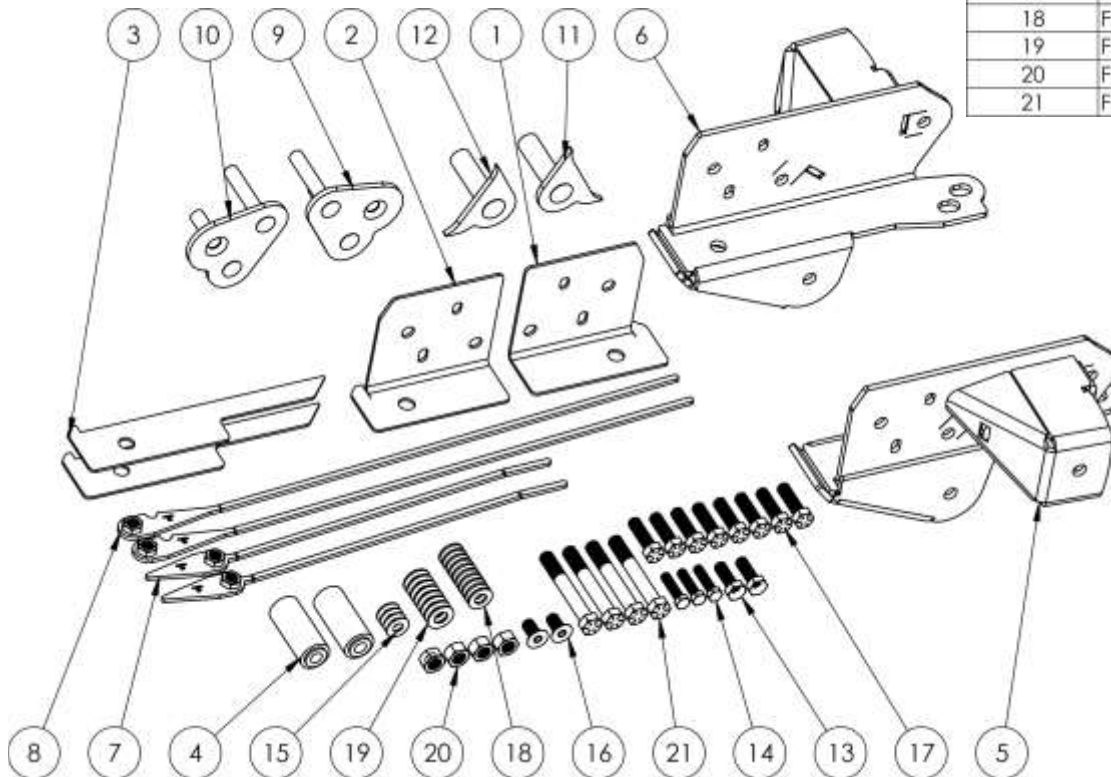

Section 3: Installation Instructions

Important Note: MetalCloak recommends replacing the factory drive shaft. The factory drive shaft binds at transfer case side and the factory drive shaft is too short for additional travel. An aftermarket drive shaft clears t-case and is optimal for maximum travel

Factory Drive Shaft T-Case Bind

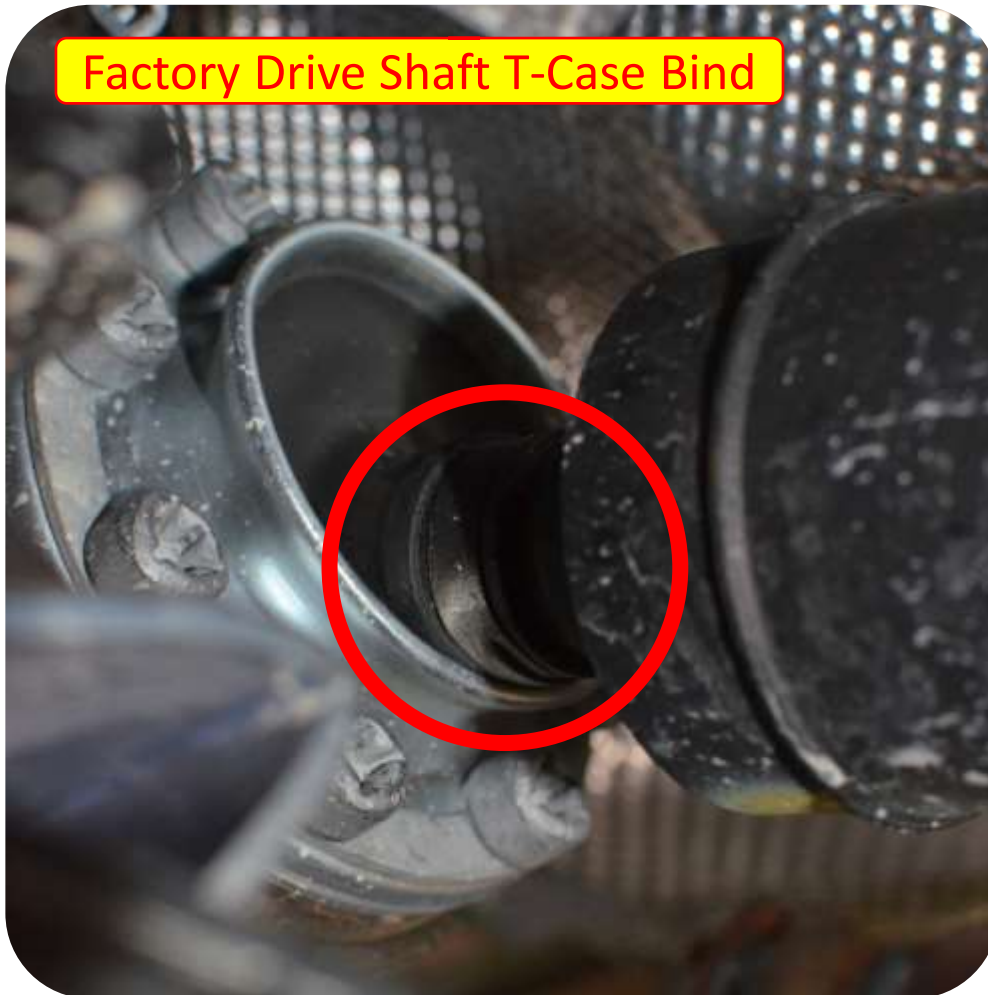

Factory Drive Shaft Misalignment



Aftermarket Drive Shaft Correction



Section 3: Installation Instructions



Important Note: *MetalCloak does not recommend powder coating your True Dual Rate Coils. The baking process in powder coating can, in some cases, cause the metallurgical properties of the coils to be changed, resulting in the loss of the lift properties of the coils. As such, the process of powder coating the coils will void any warranty stated or implied in relation to the coils.*

Important Note: *To install lift components you will need to fully 'droop' your suspension in the front and rear (not at the same time). We strongly recommend that the vehicle be placed on an automotive lift and that all appropriate safety precautions be taken to secure the vehicle while it is off the ground. Always use the necessary axle stands (or equivalent) to support the axle when the suspension components are disconnected for safety, and to ensure the integrity of your suspension system during the installation process.*

Section 3: Installation Instructions

Step 1: Remove Stock Components

- A. Disconnect front sway bar links using a 18MM wrench and 6MM Allen Wrench. **Save all Hardware**
- B. Using a 10MM Socket disconnect the brake line brackets that is attached to the frame. **Save all Hardware.**

Important Note: The brake line on the lower front control arms (drivers and passenger side) must be removed from the bracket. It may be pried out or cut; be VERY careful not to damage the brake line!!!

Important Note: To help prevent strain on the brake lines MetalCloak recommends clipping all zip ties attached to the brake lines.

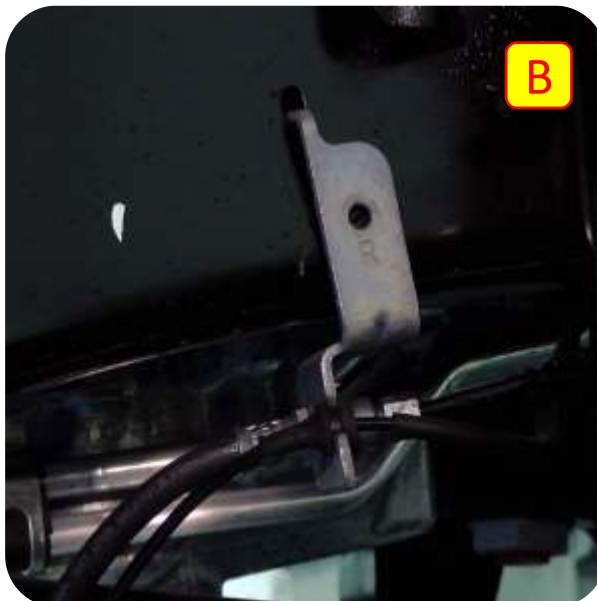
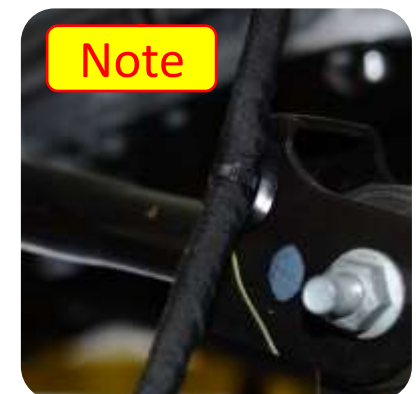

Section 3: Installation Instructions

Step 1: Remove Stock Components

Important Note: Disconnect any electronics attached to the axle (Locker plug, Front axle disconnect plug, etc.)

- C. Using a 21MM Socket disconnect the stock track bar. Save all hardware.
- D. Use a 18MM Socket and Wrench to remove the shocks. Save all hardware
- E. Remove stock springs, and any spacers that have been used if vehicle has been previously lifted.

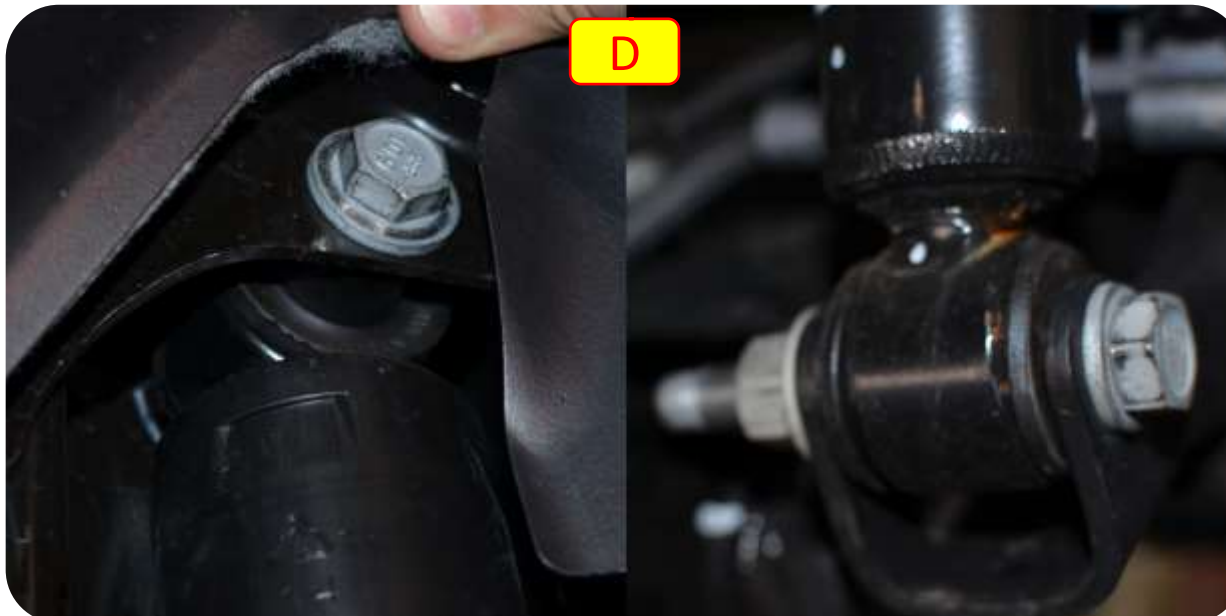

Section 3: Installation Instructions



Step 2: Install MetalCloak Crossmember

Note: Before removing the crossmember support the transmission and transfer case with jackstands.

- F. Remove the factory cross member and install the provided MetalCloak cross member using 21mm socket at the transmission mount, a 13mm socket for the exhaust mount and 18mm socket and wrench for the crossmember.

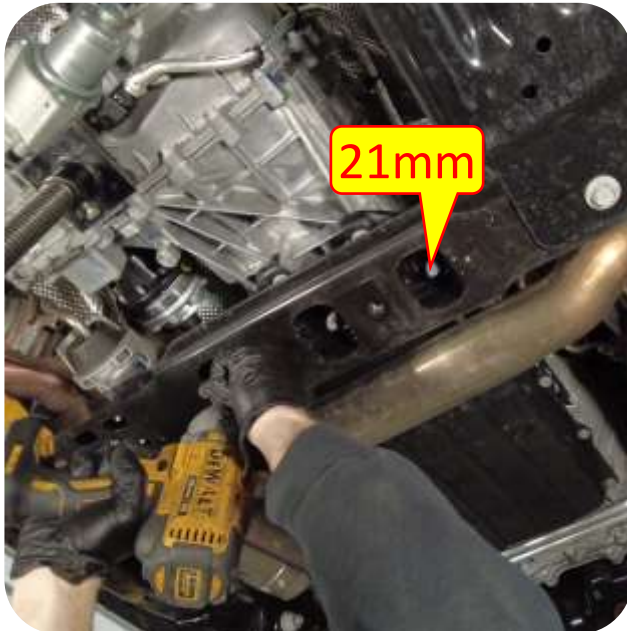

Section 3: Installation Instructions

Step 3: Disconnect Front Control Arms (*Stock Control Arms*)

Note: Make sure to use jack stands to support the axle before removing the control arms.

Note: The brake line on the lower front control arms (drivers and passenger side) must be removed from the bracket. It may be pried out or cut; be VERY careful not to damage the brake line!!!

Note: On the passenger side upper control arm you will need to cut the stock bolt as the exhaust interferes with the bolt removal.

- G. Disconnect the upper control arm heat shield on both sides at the frame using a 10MM Socket. Save heat shields and all hardware.
- H. Use a 24mm Socket & Wrench to remove the stock bolts from the front lower control arms. **Save all hardware.**
- I. Using a 18mm wrench and socket remove the Front Upper Control Arms. **Save all hardware.**

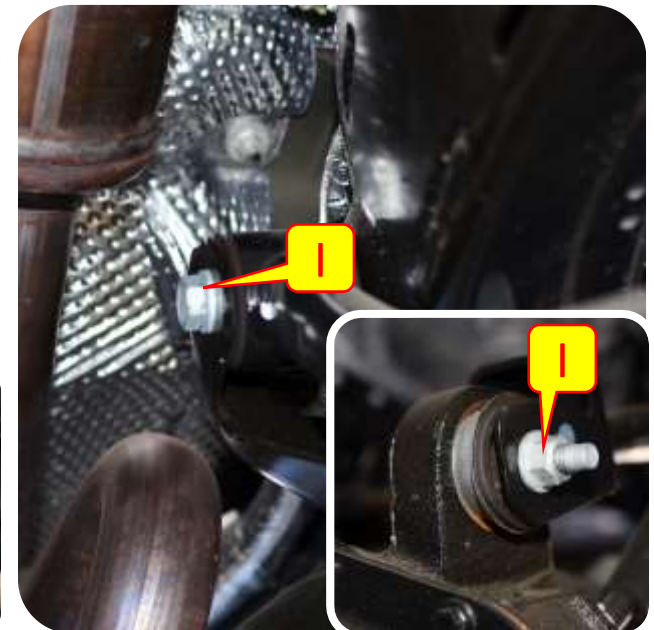
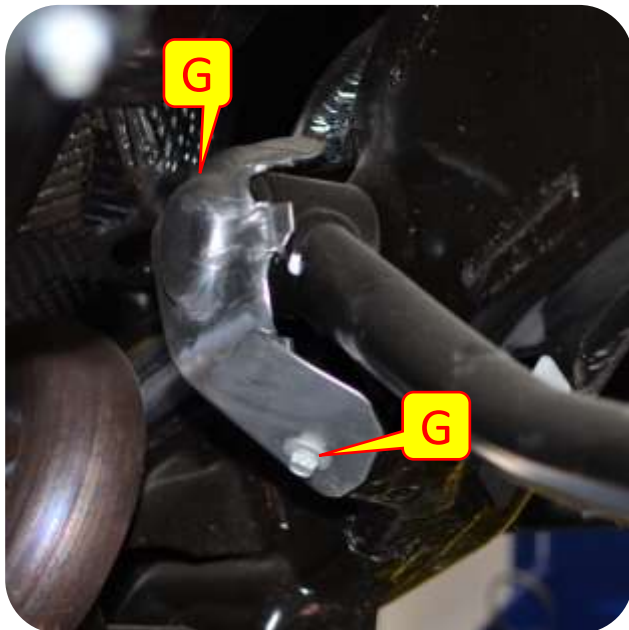

Section 3: Installation Instructions



Step 3: Disconnect Front Control Arms (*MetalCloak Mid Arms*)

Note: Make sure to use jack stands to support the axle before removing the control arms.

- J. Disconnect the front lower control arms using a 24mm socket & wrench. **Save Hardware.**
- K. Disconnect the front upper control arms using a 18mm socket and wrench. **Save Hardware.**

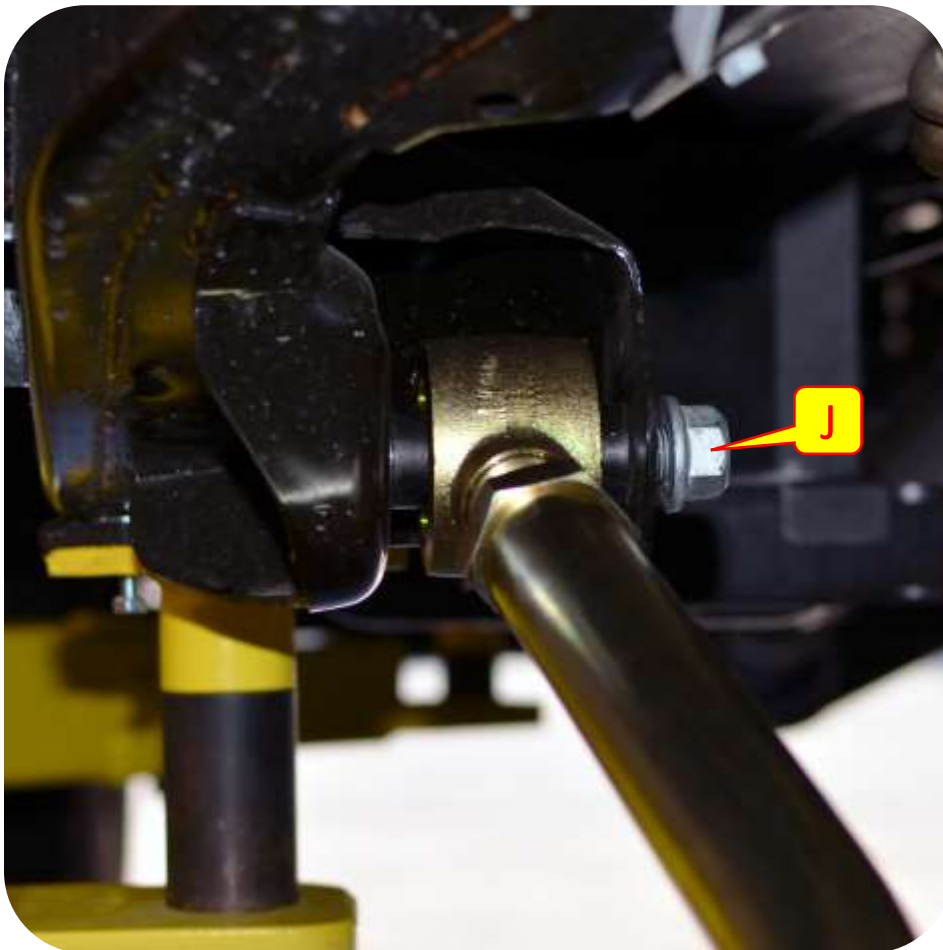

Section 3: Installation Instructions

Step 4: Removing Stock Control Arm Mounts

Note: You can unbolt and remove driver and passenger catalytic converters from the vehicle. This will allow more room for removal of factory bracketry and later installation of upper control arms bolts. **This step is optional and is not required.**

- L. Using a cut off wheel & grinder or torch remove the factory front control arm brackets from the frame.
- M. Clean and paint any exposed metal to prevent rust.

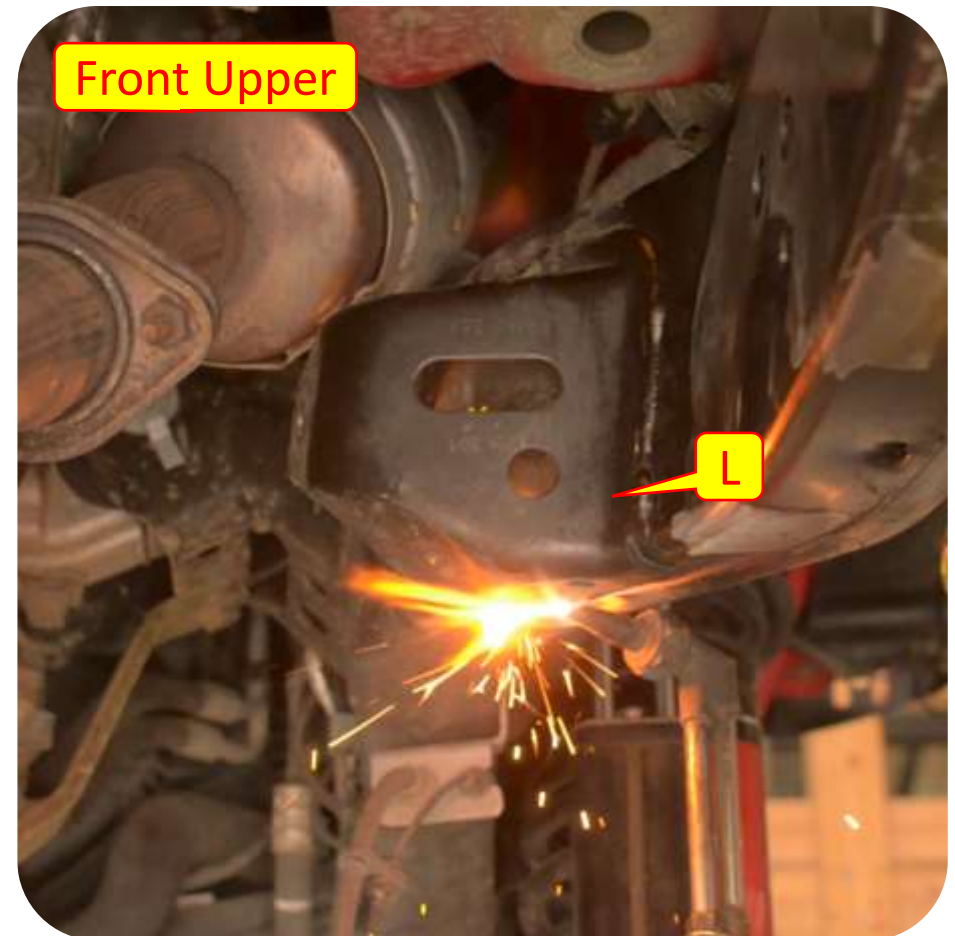
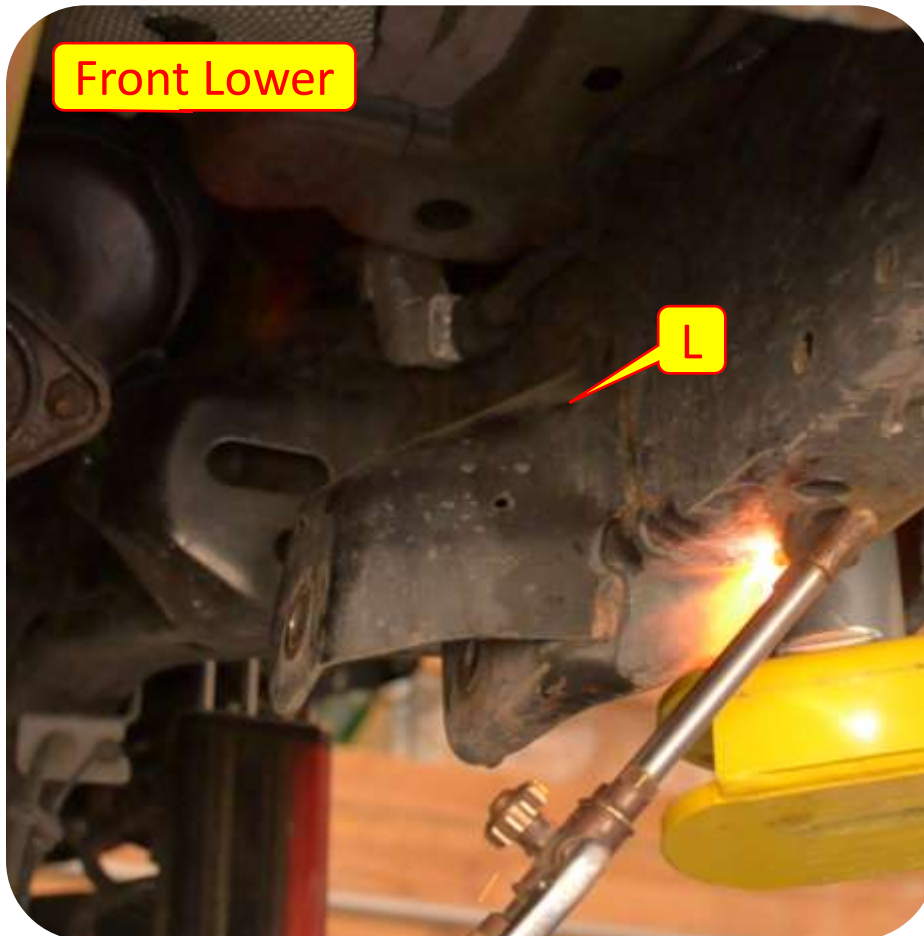

Section 3: Installation Instructions

Step 5: Install the Front Lower Control Arm Bracket

M. Install the lower control arm bracket to the crossmember using the provided 1/2" bolts (3/4" head), washers and nuts and hand tighten.

Note: The passenger side lower control arm bracket comes with a shim to be placed between the bracket and the crossmember.



Section 3: Installation Instructions

Step 5: Install the Front Lower Control Arm Bracket

- N. Insert flag nut (*BOM#3*) into the frame and install the 3/4" head bolt and washer through the control arm bracket at the bottom of the frame.
- O. Insert flag nut (*BOM#4*) into the side of the frame and install 3/4" bolt through control arm bracket and frame.
- P. Tighten all lower control arm bracket hardware.

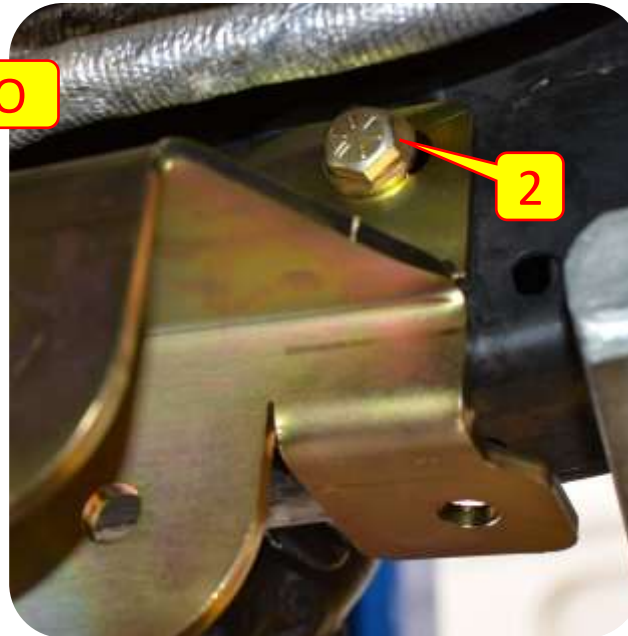
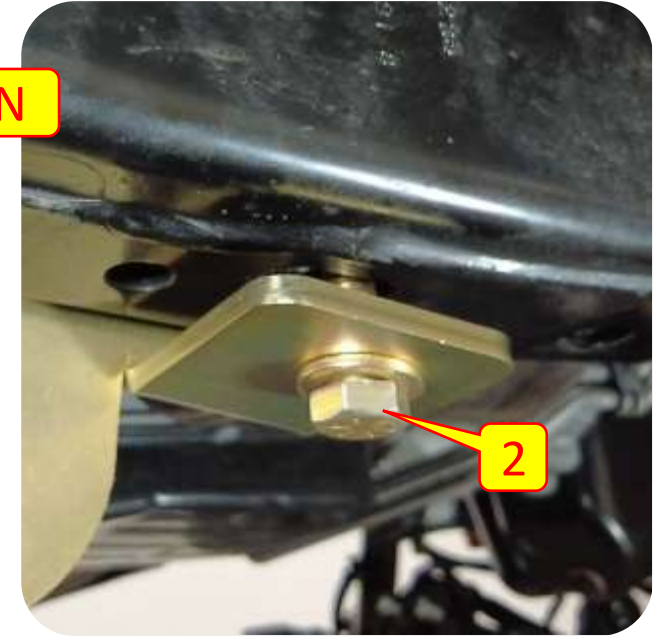
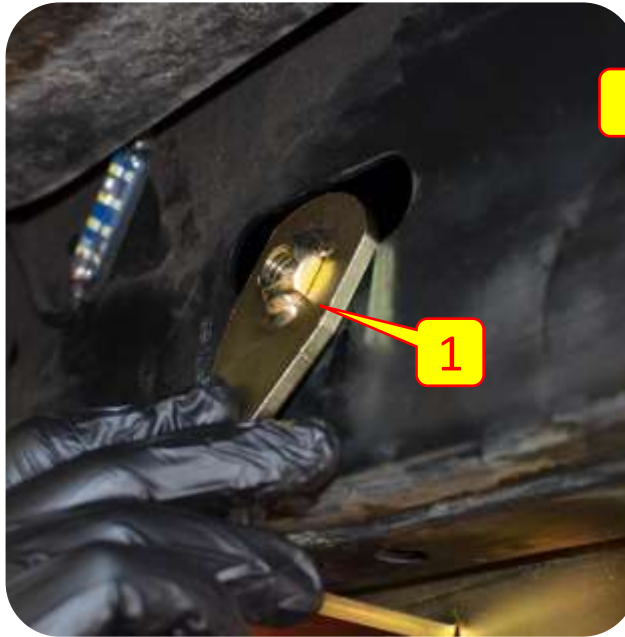

Section 3: Installation Instructions

Step 6: Install the Front Upper Control Arm Bracket

- Q. Place upper control arm bracket up to frame and align rear most slot on the bottom of the bracket with factory threaded insert using the provided 18mm head 12mm bolt. Insert the bolt and snug holding the bracket with pressure to the rear of the vehicle.
- R. Use a jack or c clamp to pull the rest of the bracket tight up to the vehicles frame.
- S. Mark the 1 hole on the bracket for drilling.

Note: *If your vehicle is equipped with the factory crash bar on the passenger side frame rail, trace the profile of the lower large hole just rear of the arm pocket.*

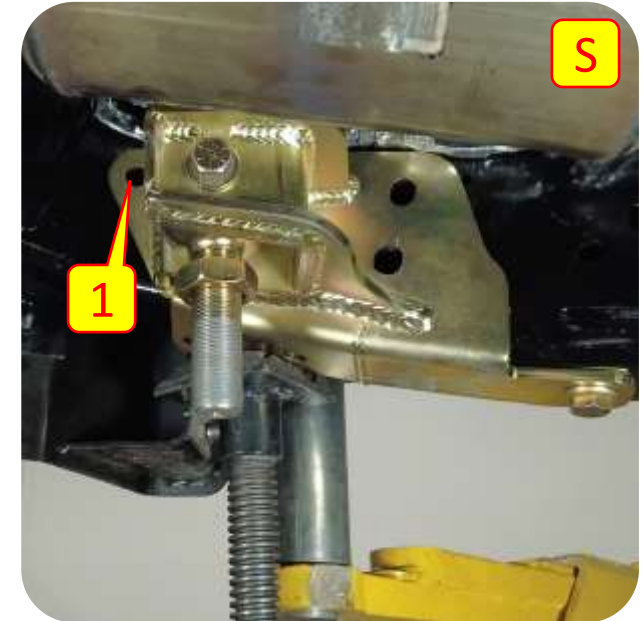
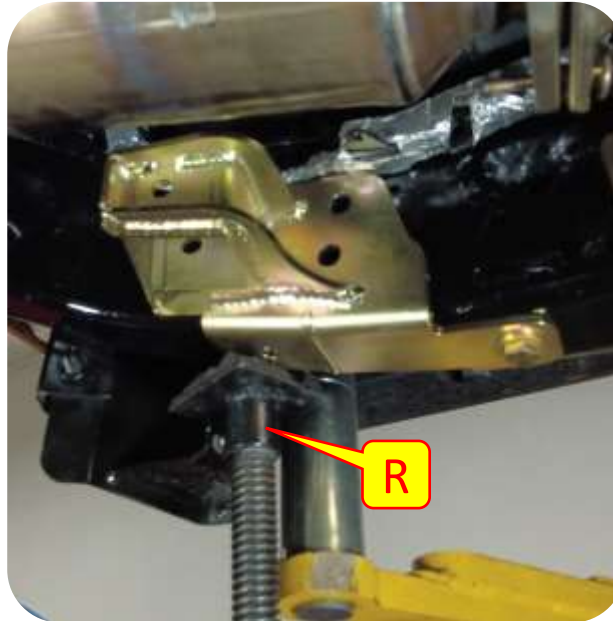

Section 3: Installation Instructions

Step 6: Install the Front Upper Control Arm Bracket

- T. Remove the bracket and drill you 2x 1/2 holes and if equipped with the crash bar clearance the marked hole using a die girder or something similar.
- U. Place upper control are bracket up to frame and align rear most slot on the bottom of the bracket with factory threaded insert using the provided 18mm head 12mm bolt. Insert the bolt and snug holding the bracket with pressure to the rear of the vehicle.
- V. Use a jack or c clamp to pull the rest of the bracket tight up to the vehicles frame.

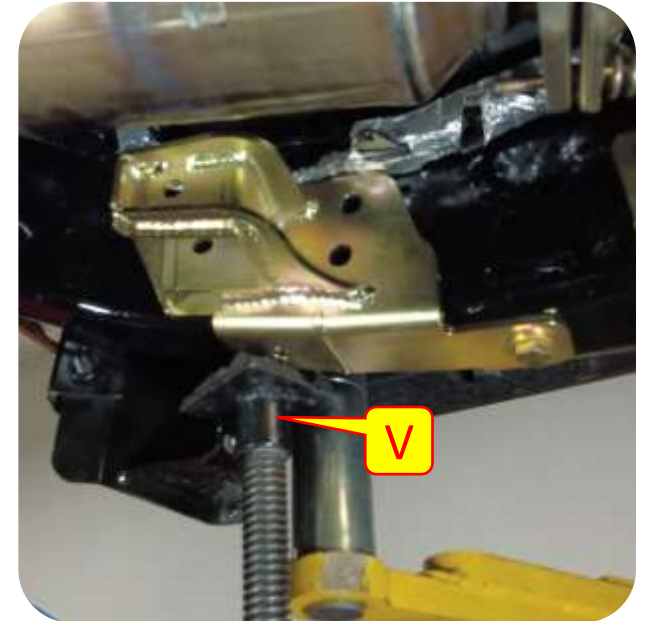

Section 3: Installation Instructions

Step 6: Install the Front Upper Control Arm Bracket

- W. Insert flag nut BOM #3 into the same slot as step K. Align with the 2 holes on the rear side of the bracket and install the two provided 3/4" head 1/2" bolts into this flag plate.
- X. Insert flag nut BOM #7 into the hole in the frame just ahead of the body mount and align with the hole on the inside from most hole drilled earlier. install provided bolt.



Section 3: Installation Instructions

Step 6: Install the Front Upper Control Arm Bracket

- Y. Using a 1/2" drill bit drill out the lower front hole on the frame.
- Z. Insert the flag nut BOM #1 into the hole in the side of the frame between the mounts and install the provided bolt into the front most bottom hole drilled out in step Y.

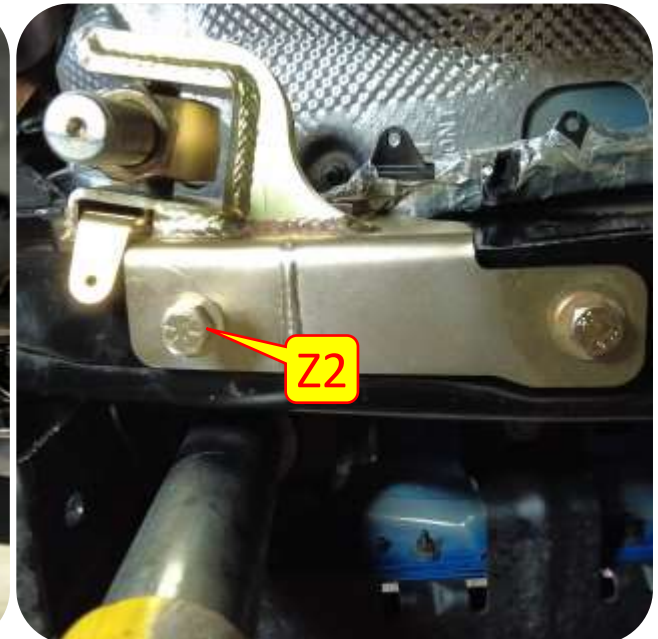

Section 3: Installation Instructions

Step 6: Install the Front Upper Control Arm Bracket

Note: Measure the upper front control arms to 26 3/4" eye to eye and the lower rear control arms to 37 9/16" eye to eye. These control arm specifications are just starting points. **ALL JEEPS ARE DIFFERENT.** MetalCloak recommends seeing a suspension specialist for correct control arm lengths for **YOUR** Jeep.

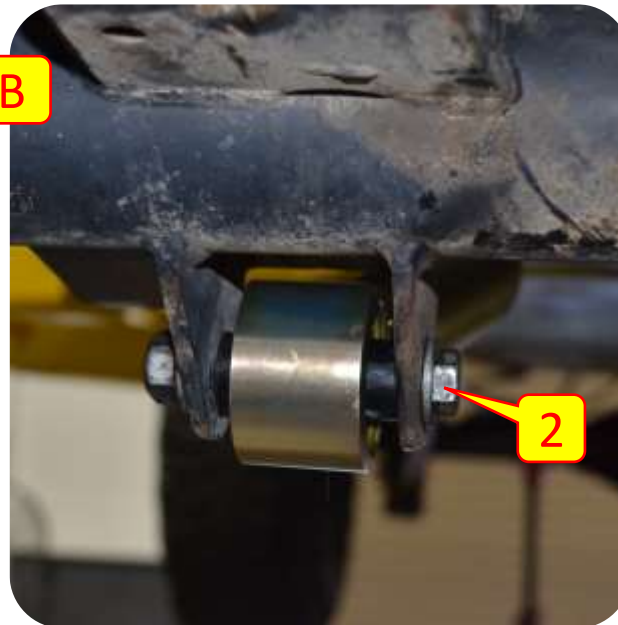
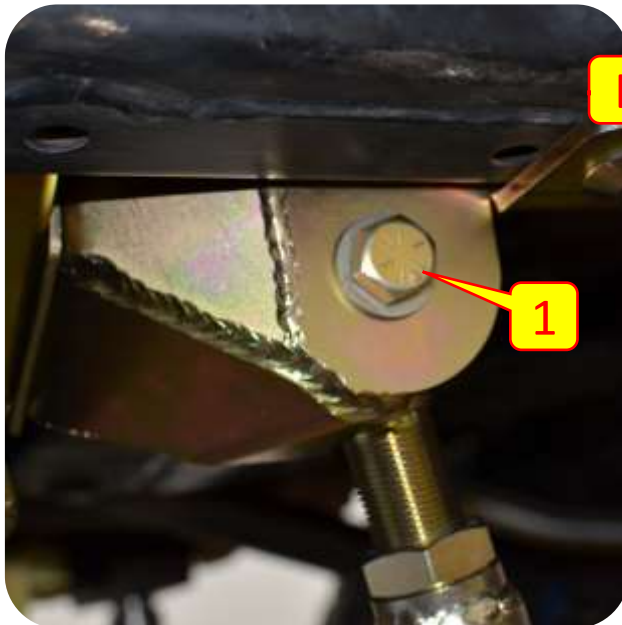
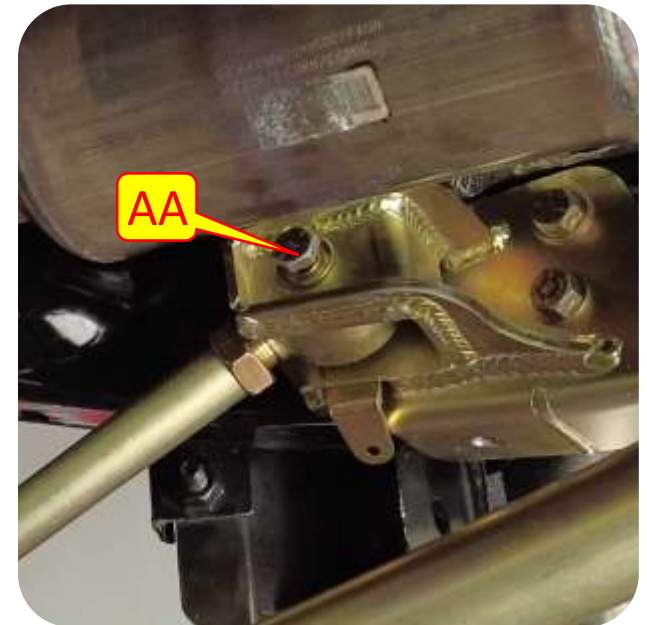

- AA. Install the front upper control arm into the upper control arm bracket loosely using the provided 1/2" bolt and flag nut (BOM#3 & BOM#11).
- BB. Install the lower control arm into the axle and bracket at the crossmember using a 13/16" socket at the frame and the factory 21mm bolt at the axle.
- CC. Set the caster and install the upper control arms at the axle end using the factory hardware.



Section 3: Installation Instructions

Coil Isolator Information Guide

Important Note: MetalCloak's suspension systems include a unique coil design that utilizes upper isolators to position the coil. The following table will help you identify where to install the isolators included with your kit. You must remove the stock isolators before installing the provided coil isolators. If you have any questions give us a call at 916-631-8071.

Coil Isolator Jeep Locations		
Tall Isolator	Jeep Model	Installation Locations
	JL Wrangler 3.6L Non-E Torque	Upper Front Passenger
	JL Wrangler 2.0T E-Torque	Upper Front Driver & Passenger
	JL Wrangler 4xE	Upper Front Driver & Passenger
	JL Wrangler Diesel	Upper Front Driver & Passenger
	JT Gladiator Diesel	Upper Front Driver & Passenger
Short Isolator	Jeep Model	Installation Locations
	JK Wrangler (All Models)	Upper Front Driver & Passenger
	JL Wrangler 3.6L Non-E Torque	Upper Front Driver
	JL Wrangler 3.6L E-Torque	Upper Front Driver & Passenger
	JL Wrangler Turbo	Upper Front Driver & Passenger
	JL Gladiator 3.6L Motor	Upper Front Driver & Passenger
Rear Isolator	Jeep Model	Installation Locations
	JL Wrangler 3.6L Non-E Torque	Upper Rear Passenger
	JL Wrangler 4xE	Upper Front Driver & Passenger

Section 3: Installation Instructions

Step 8: Install Coils and Bump Stops

- DD. Using a 10mm socket disconnect the bracket from the spring perch on the axle.
- EE. Drill out the center hole using a step bit, or you can start your hole with a smaller drill bit and work your way up to a 1/2".
- FF. Install the front coils. Make sure the tightly wound coils are oriented upward.
- GG. Slip the bottom of the coil onto the coil base on the axle. Rotate the coil until it is seated properly on the coil base.

Important Note: Droop your suspension to gain access to the spring perch. Be sure to watch the ABS lines so they do not get over extended and break.

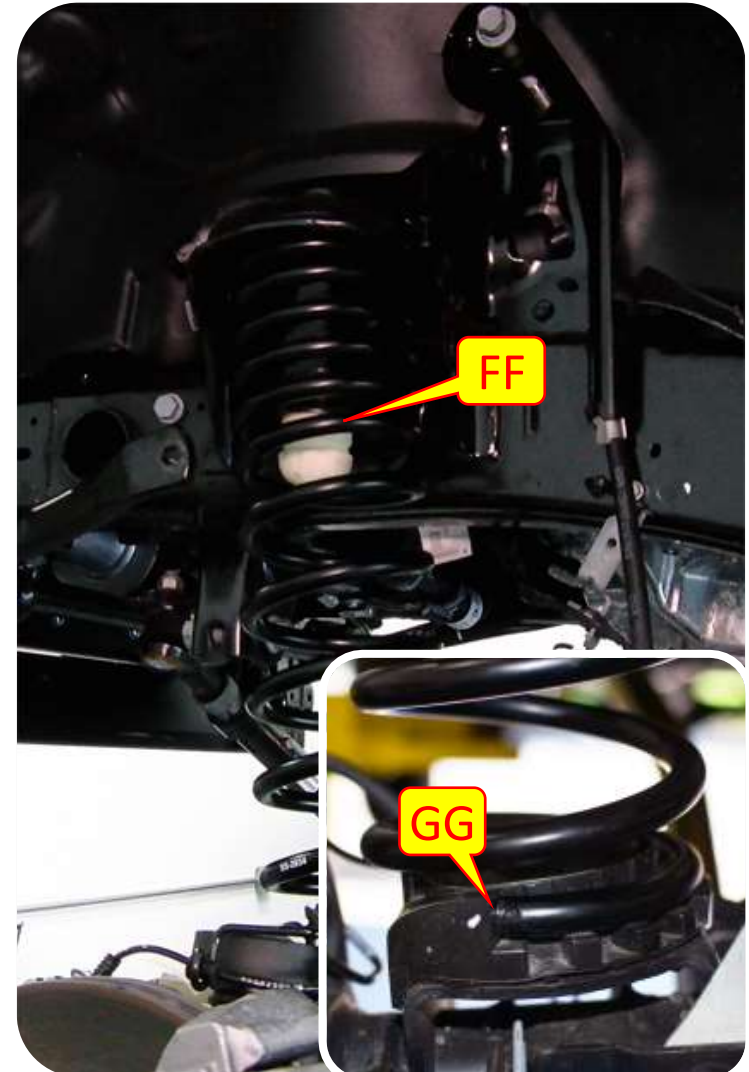

Important Note: If the axle does not droop enough to allow the coil to be put in place a coil compressor can be used to compress the coil to allow fitment.

Section 3: Installation Instructions

Step 8: Install Coils and Bump Stops

Important Note: Your individual build may require an addition or removal of bump stop pucks for your tire size fitment.

HH. Select the appropriate Screw length so that the threads stick out of the bottom Disks approximately $\frac{3}{4}$ ". Assemble your bump stops inside the installed coil by feeding the $\frac{1}{2}$ " Countersunk Screw through the Cover Plate, and then threading through the Bump Stop Disks. The center hole in the Disk is intentionally small to create the most rigid assembly possible after installation.

II. The $\frac{1}{2}$ " Screw is backed by a $\frac{1}{2}$ " Flanged Nylon Lock Nut. Install the nut and tighten the hardware using a $\frac{5}{16}$ " Hex Key Socket or Allen Wrench and a $\frac{3}{4}$ " Wrench. Tighten until everything is tight; the hardware will not bottom out, but instead will begin to compress the Disks.



Section 3: Front Shock Installation Instructions



Step 4: Install Shocks and Mounts

Important Note: The front driver side shock will hit the lower shock mount during articulation you must grind the shock mount before installing. (See page 13)

- JJ. Place the shock bracket into place aligning the top bracket hole to the factory location and install the stock bolt into the top hole of the bracket and tighten with the side hole against the coil bucket.
- KK. Using a 1/2" drill bit drill out the side hole. Once the hole is drilled loosen the top shock bracket bolt.
- LL. Using a 3/4 socket and wrench tighten down the side bolt.
- MM. Install the bushing end (top) of the 6Pak shock and the spacer on the inboard side of the bushing end.
- NN. Install Stock Shock.

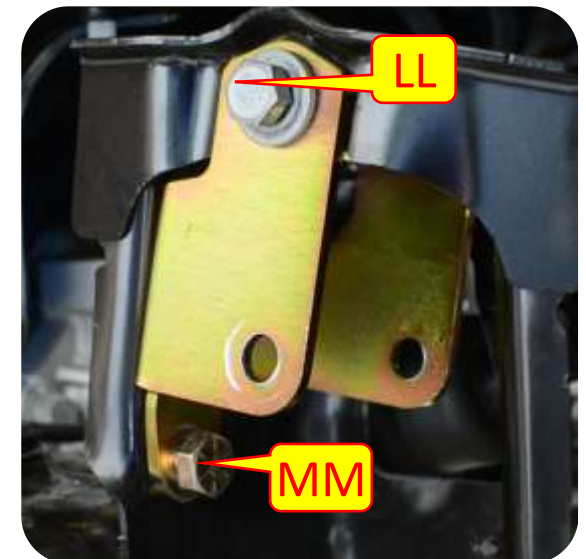

Section 3: Installation Instructions



Step 11: Install Front Track Bar

- OO. Install the front track bar. Making sure the adjustable end of the track bar goes into the stock bracket on the axle. Re use the stock hardware.
- PP. Install the fixed end of the track bar into the stock frame bracket. The clearance bends should point towards the front bumper, up and away from the differential cover. Re use the stock hardware.
- QQ. Fully tighten the stock hardware on both ends of the Track Bar using a 21MM socket and wrench, and then tighten the Jam Nut on the Track Bar.
- RR. MetalCloak **STRONGLY RECOMMENDS** having your alignment checked by a professional after changing any suspension components.

Note: *It is helpful to have someone push the vehicle to the driver or passenger side to help align the hole; if you don't have an extra pair of hands you can use a ratchet strap on the frame/axle to pull the frame in the desired direction. Lower the Jeep to the ground to ensure the axle is centered once the bolt is in place. If not then remove the bolt, adjust the Track Bar length, replace the bolt, and re-check axle centeredness. Repeat until the axle is as close to center.*



Section 3: Installation Instructions

Step 11: Install Front Track Bar

Note: MetalCloak uses an over-sized forged housing for additional strength; the factory window pocket may need additional clearance for optimal fitment. Use a die grinder and cutting bit to enlarge the existing window in the factory track bar bracket.



Section 3: Installation Instructions



Step 12: Install Sway Bar End Links

SS. Using the factory hardware install the bottom of the MetalCloak extended sway bar links.

TT. Using the supplied hardware install the top of the MetalCloak extended sway bar links

UU. Tighten sway bar end links with an 18MM Wrench for the factory hardware and a 3/4" & 18MM wrench for the supplied hardware.

Important Note: MetalCloak recommends using red Loctite on each of the upper spindles of the sway bar end links.

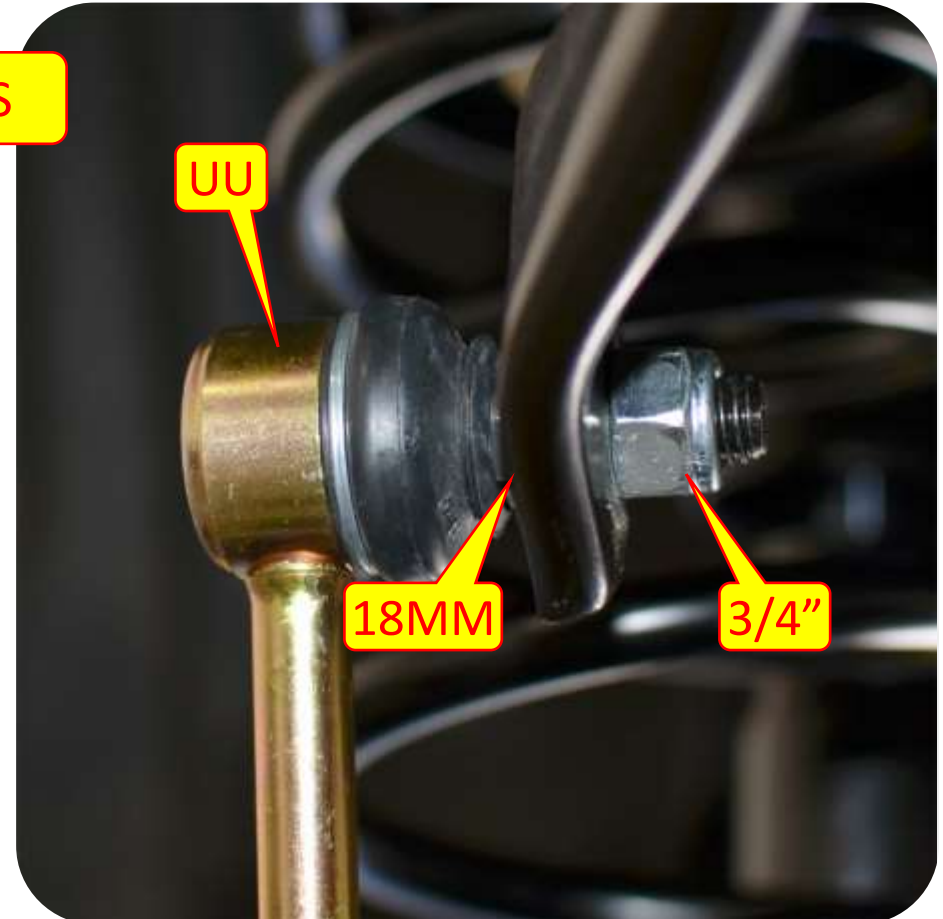
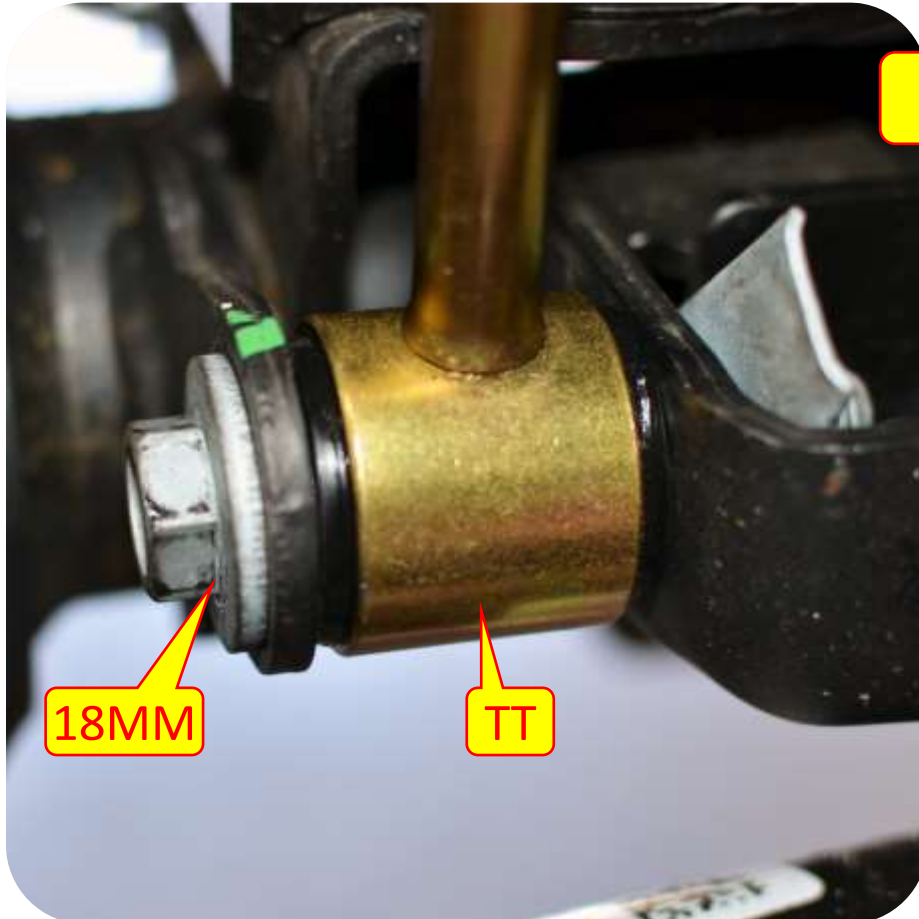

Section 3: Installation Instructions



Step 13: Finalize Installation

VV. Adjust the caster angle and toe as needed. Once set, tighten all hardware, Re attach all brackets and reinstall the heat shield. Finally, tighten the jam nuts on all control arms.

Note: When lifting any vehicle, basic dynamics are changed. It is important to take your vehicle to a professional for an alignment after installation. Make sure caster setting is adjusted for a lifted vehicle (not stock specs).

Section 3: Installation Instructions



Step 1: Remove Stock Components

Important Note: MetalCloak Recommends removing the bottom rear fender well plate for easier access to the upper shock bolts by using a 8MM socket wrench.



Section 3: Installation Instructions

Step 1: Remove Stock Components

- A. Using a 18mm socket and wrench disconnect the stock shocks. **Save all hardware.**
- B. Disconnect the brake line brackets and E-brake cable on the axle to help allow for full droop.
- C. Disconnect the rear sway bar links using an 18MM wrench and 6MM Allen wrench. **Save all hardware.**
- D. Using a 21MM Socket and wrench disconnect the stock rear track bar. **Save all Hardware.**
- E. Remove Stock Coils.

Important Note: Disconnect any electronics attached to the axle (Locker plug, etc.)

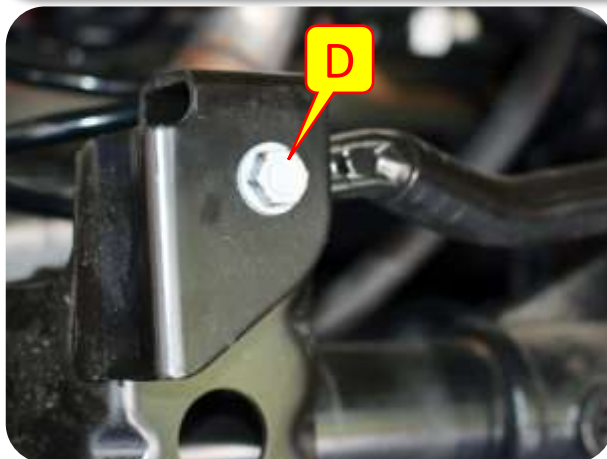
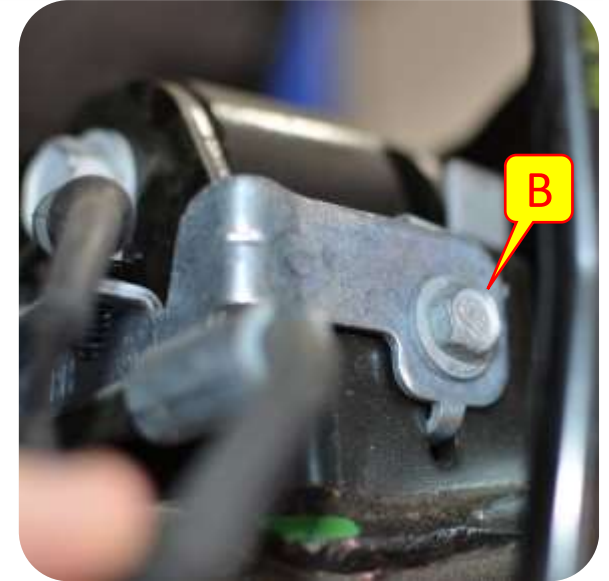
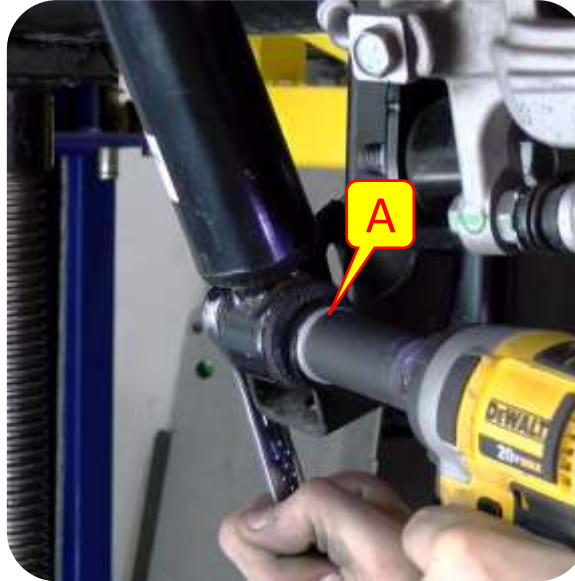

Section 3: Installation Instructions

Step 2: Remove Gas Tank

- D. Remove filler breather by removing the plastic retaining clip before pressing on the line fitting. ****be careful not to break as they are not very strong****
- E. Remove any plastic "Christmas trees" that may be connecting the fuel line to the gas tank.
- F. Remove the fuel lines in front of the gas tank by removing plastic retaining clip before pressing down on the line fitting. ****Be careful as these lines may be under pressure and release fuel. We recommend using a container to catch any released fuel to prevent mess.****



Section 3: Installation Instructions

Step 2: Remove Gas Tank

- G. Remove evap canister hoses by pressing on the line fittings.
- H. Remove the gas tank.

Important Note: Move the gas tank at least 25 ft away and make sure the room is well vented as we will be drilling and grinding.



Section 3: Installation Instructions

Step 3: Rear Control Arm Bolt On Bracket Installation

- I. Support the rear axle with jack stands and remove the rear control arms using a 21mm socket and wrench.
- J. Using a cut off wheel/grinder or torch; remove the existing rear control arm brackets from the frame, clean the frame and paint the left-over exposed metal.
- K. Make sure to grind down the factory weld spatter on each side of the frame so it is flush and paint the exposed metal to prevent rust

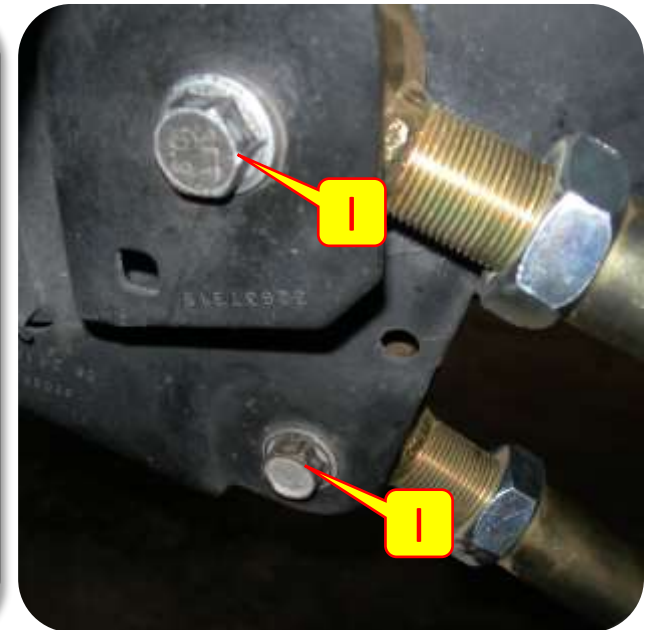

Section 3: Installation Instructions

Step 3: Rear Control Arm Bolt On Bracket Installation

- L. Thread in the tapered flat head bolt into the threaded frame insert as shown, this will help prevent losing it inside the frame by accident.
- M. Insert the spacer through the outer part of the frame as shown.
- N. Once the space is lined up, remove the hardware and place the large frame plate onto the frame, then reinstall the 5/16 allen flat head bolt.
- O. Install the small frame plate.

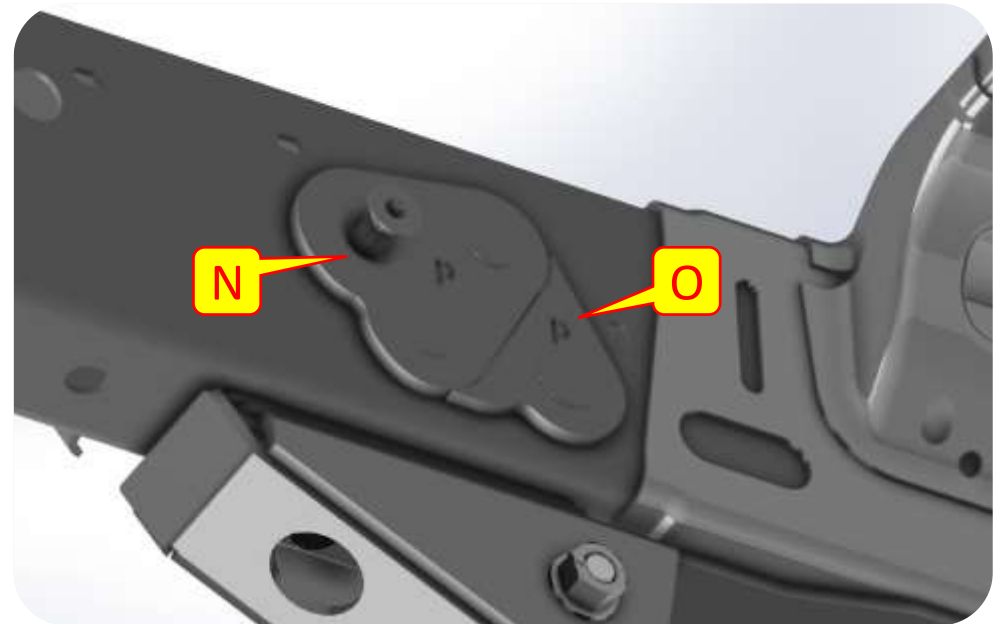

Section 3: Installation Instructions

Step 3: Rear Control Arm Bolt On Bracket Installation

P. Place the control arm bracket shims into the inside of the rear control arm bracket.

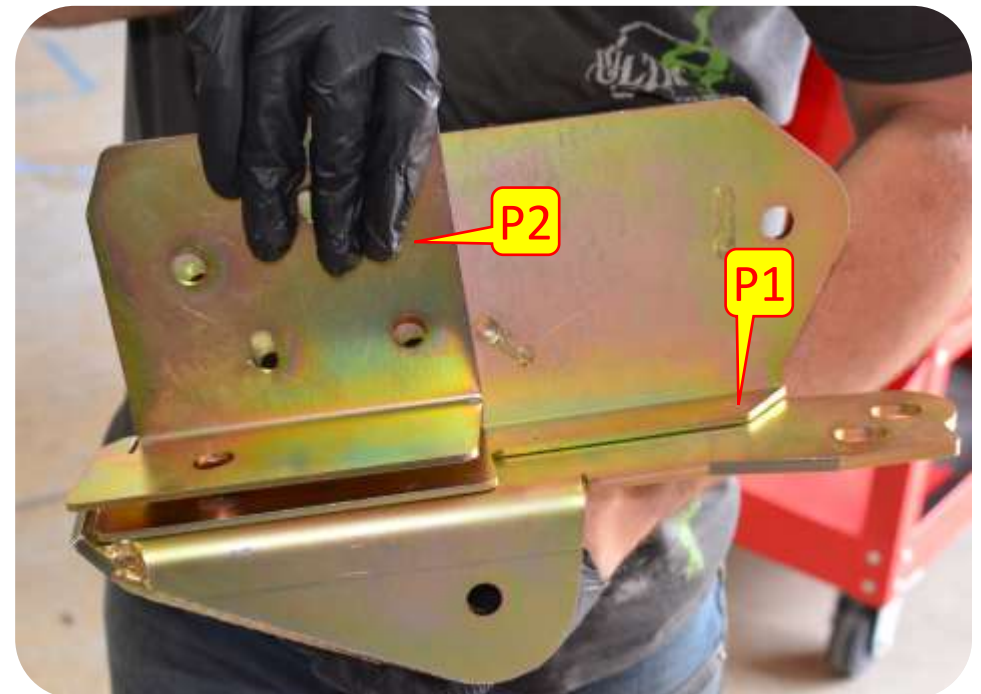

Section 3: Installation Instructions

Step 3: Rear Control Arm Bolt On Bracket Installation

- Q. Place the long arm bracket onto the frame and install the provided 1/2 bolts (3/4" heads). We recommend using a floor jack or clamp to hold the bracket tight to the frame.
- R. Install provided 12mm bolts (18mm bolt head) hardware into the bottom of the bracket.
- S. Mark the hole location at the bottom and side of the bracket for drilling.
- T. Remove the bracket drill out the marked locations starting with a smaller drill bit, work your way up to 1/2 drill bit. We recommend painting any exposed metal to prevent rust.

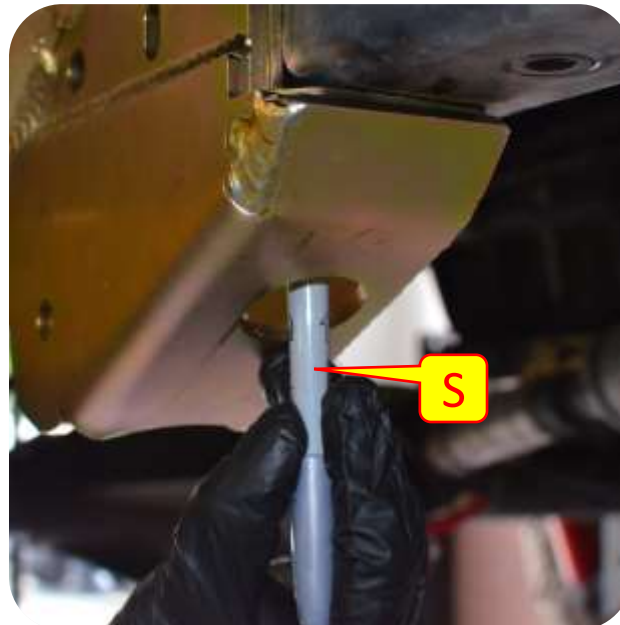
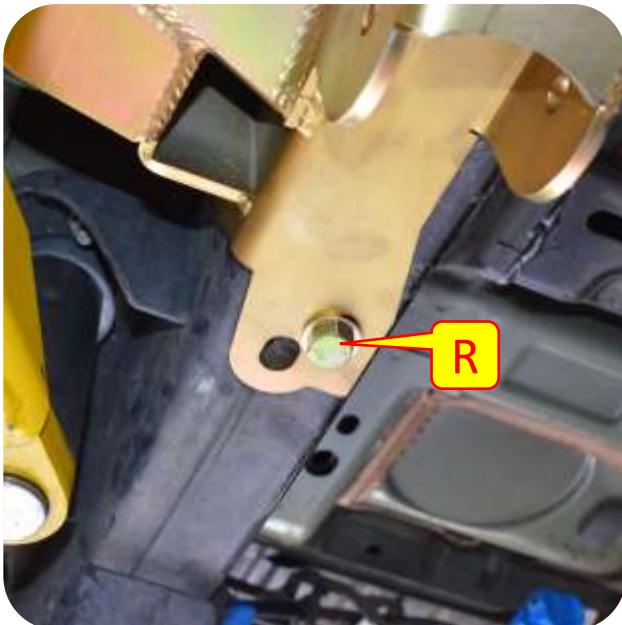

Section 3: Installation Instructions

Step 3: Rear Control Arm Bolt On Bracket Installation

- U. Reinstall the bracket with shims onto the frame, installing the 1/2" bolts (3/4 heads) and 3/8" in bolts with (9/16" heads) hardware.
- V. Insert the longer flag nut (*BOM#8*) through the hole located in the factory lower control arm mount and install the 1/2" bolt (3/4" head) hardware into the hole that was drilled in Step T.
- W. Insert the shorter flag nut (*BOM#7*) through the hole located in the factory lower control arm mount and install the 1/2" bolt (3/4" head) hardware into the hole located at the rear of the bracket.

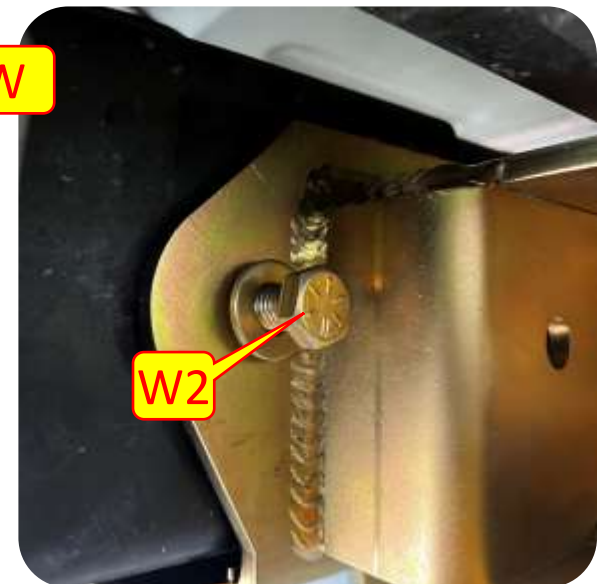
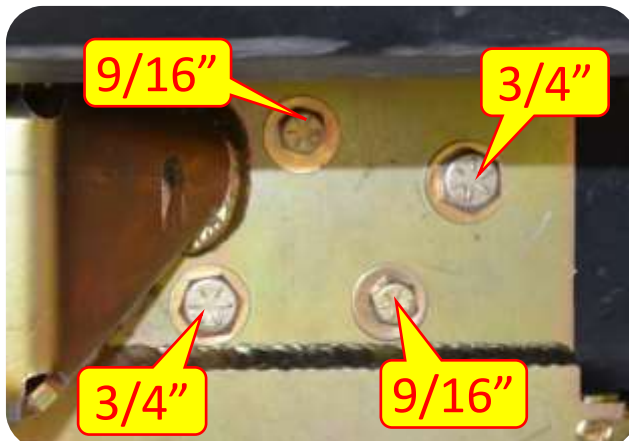
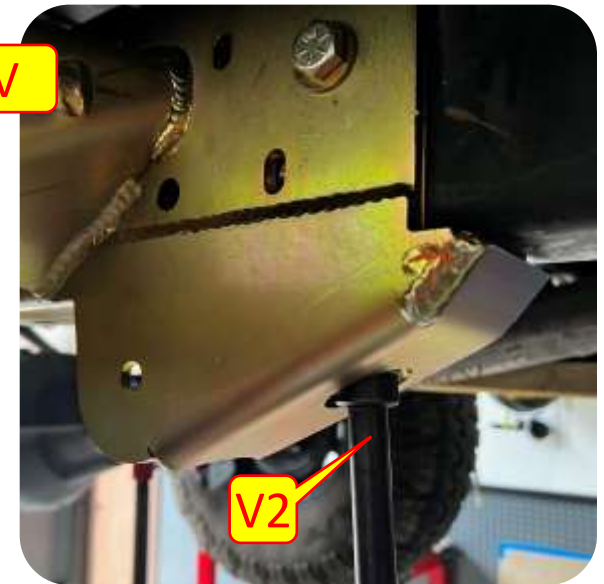

Section 3: Installation Instructions

Step 4: Gas Tank Installation

Important Note: If you're installing the rear long arm kit with our UnderCloak system. Check to see if the UnderCloak system will mount without modification. If the UnderCloak does not fit the gas tank skid plate will need to be modified, you will need to notch out the gas tank skid plate and reinstall the skid plate (See Last Page for Instructions).

Important Note 2: Cut off the gas tank mount as shown. Make sure there is plenty of ventilation before cutting the mount off.

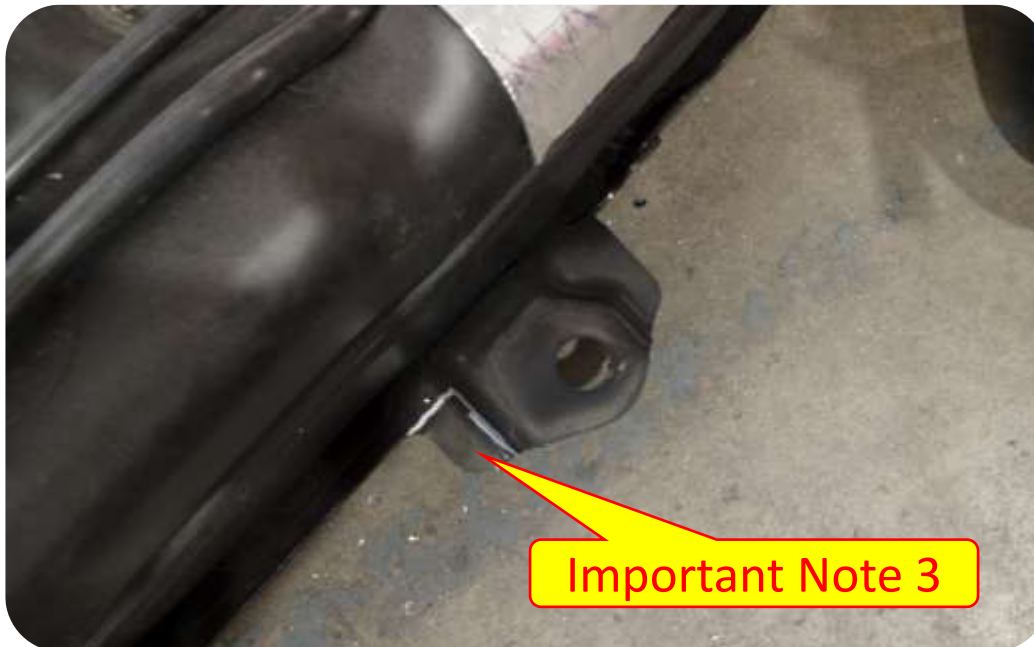
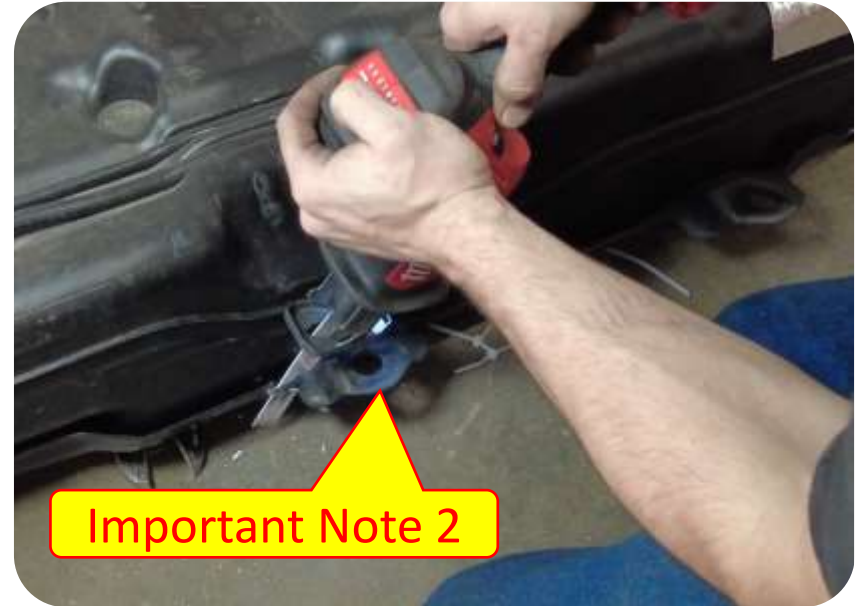

Important Note 3: Notch the tab in front of the gas tank tab that was removed. This will help the gas tank clear the rear bolt on control arm mounts.

Section 3: Installation Instructions

Step 4: Gas Tank Installation

- X. Reinstall the gas tank.
- Y. Reinstall the fuel lines in front of the gas tank.
- Z. Reinstall any plastic "Christmas trees" that connected the fuel line to the gas tank.
- AA. Reconnect filler breather.



Section 3: Installation Instructions

Step 4: Gas Tank Installation

BB. Reinstall evap canister hoses.

CC. Reconnect the gas fill neck using a 7mm socket or wench.

DD. Reinstall all the gas tank bolts with a 18mm socket.

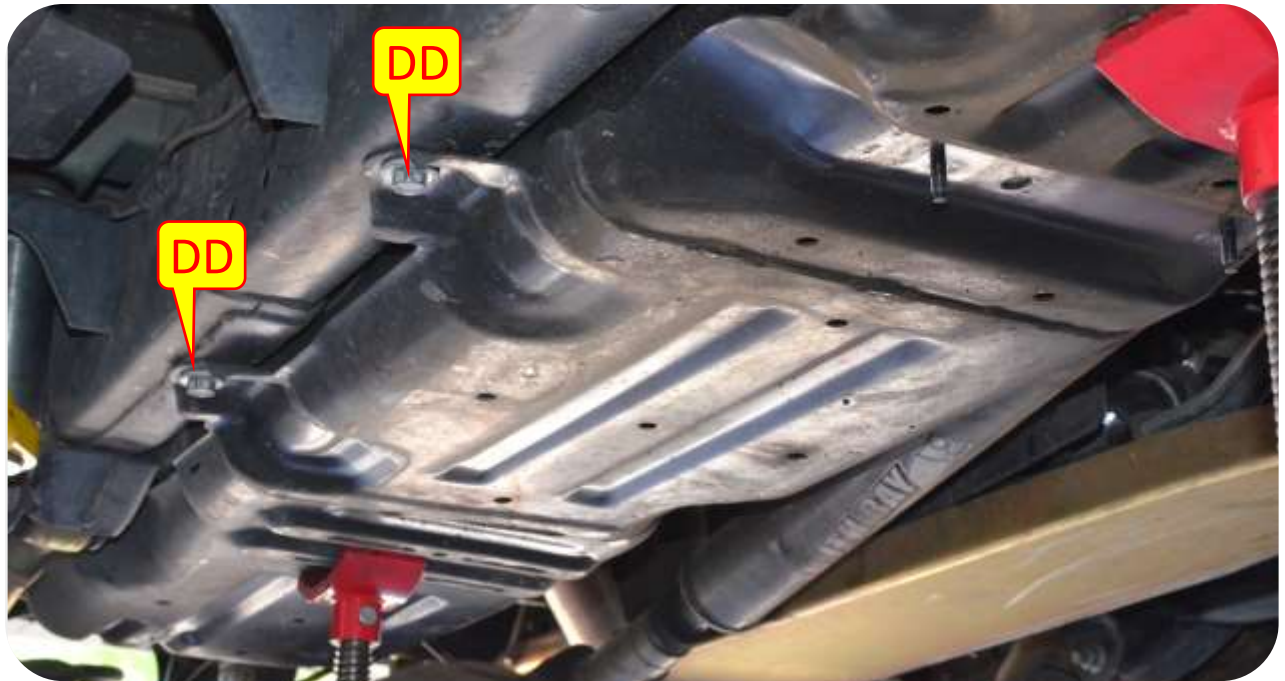
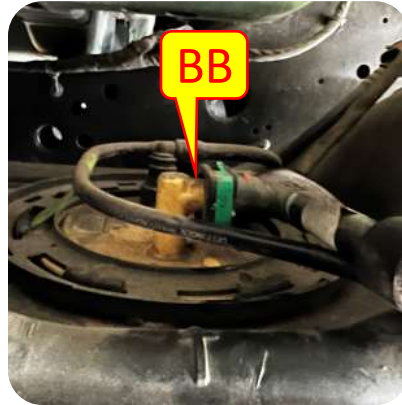

Section 3: Installation Instructions

Step 5: Rear Control Arm Installation

Note: Measure the upper rear control arms to 32 1/2" eye to eye and the lower rear control arms to 38 1/4" eye to eye. These control arm specifications are just starting points. **ALL JEEPS ARE DIFFERENT.** MetalCloak recommends seeing a suspension specialist for correct control arm lengths for **YOUR** Jeep.

- EE. Install the lower control arms orientating it so that the lock is toward the frame, using the provided 9/16" hardware and a 15/16" socket and wrench at the frame and the factory hardware using a 21mm socket and wrench at the axle end.
- FF. Install the upper control arms, orientating it so that the lock nut is toward the axle, using a 15/16" socket and wrench at the frame end and the factory hardware using a 21mm socket and wrench at the axle end.
- GG. Make sure all hardware is fully tightened.

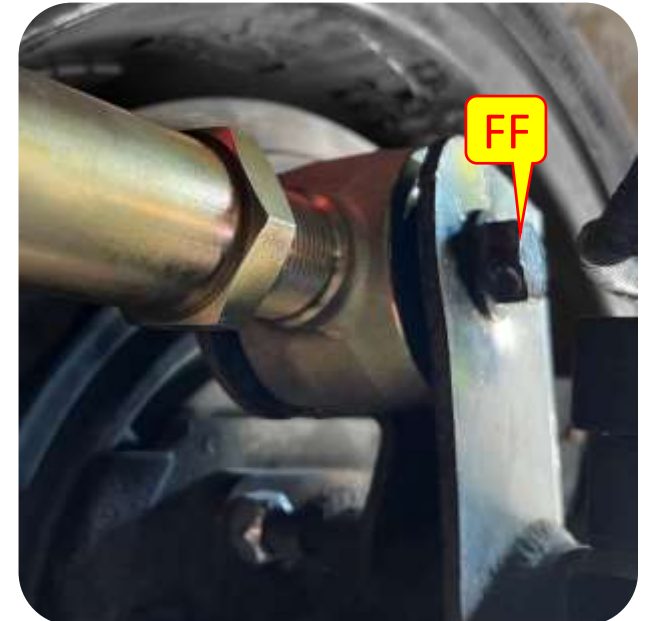
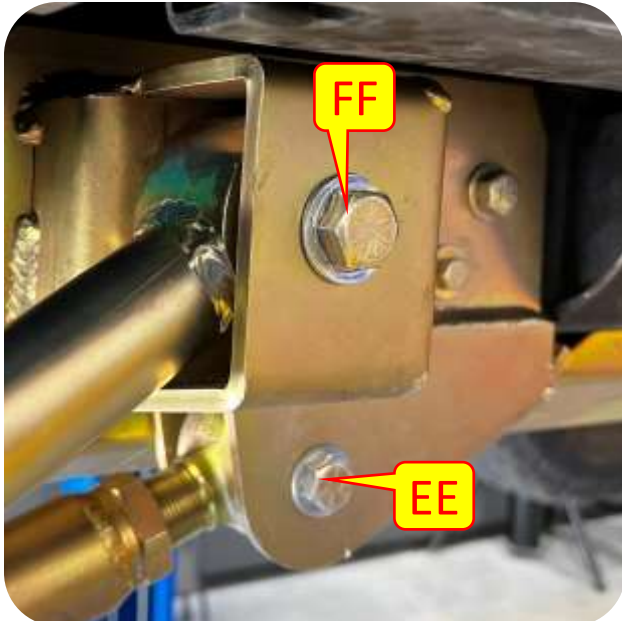

Section 3: Installation Instructions

Step 6: Install Rear Coils

- J. If the axle does not “droop” enough to allow the coil to be put in place a coil compressor can be used to compress the coil to allow fitment.
- K. Place the Rear Coil Cup on top of the Rear Dual Rate Coil.
- L. Install rear Dual Rate Coils with the tightly wound coils oriented upward.
- M. Slip the bottom of the coil onto the coil base on the axle.



Section 3: Installation Instructions



Step 7: Install MetalCloak Track Bar

N. Install the MetalCloak Track Bar using the stock hardware. Tighten all hardware using a 21MM Socket and Wrench.



Section 3: Installation Instructions

Step 8: Sway Bar Option 1

- O. Using a 15mm Socket remove the sway bar from the vehicle. **Save All Hardware**
- P. Using a 18mm socket install the 4in drop bracket in the sway bar's stock location using the factory hardware.
- Q. When reinstalling the rear sway bar flip the sway bar so that the driver side becomes the passenger side and the passenger side becomes the driver side.

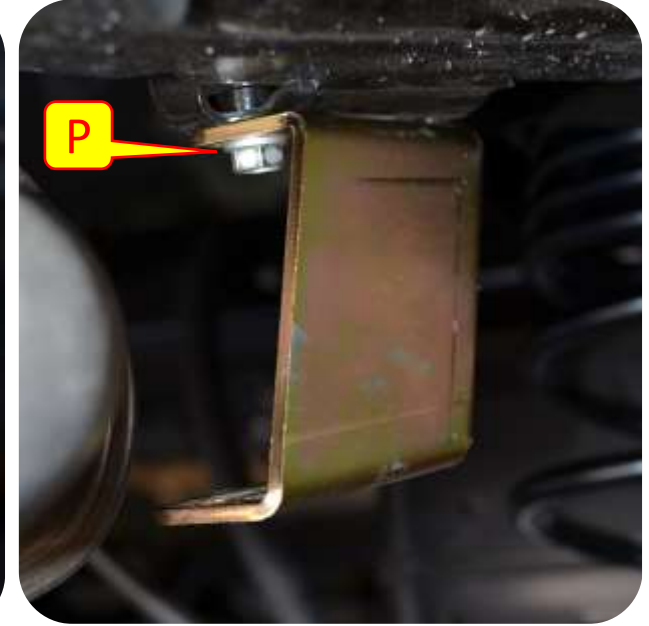

Section 3: Installation Instructions

Step 8: Sway Bar Option 1



- R. Using the provided hardware attach the sway bar to the drop bracket and tighten with a 14mm socket and wrench.
- S. Install the sway bar end links to the sway bar.

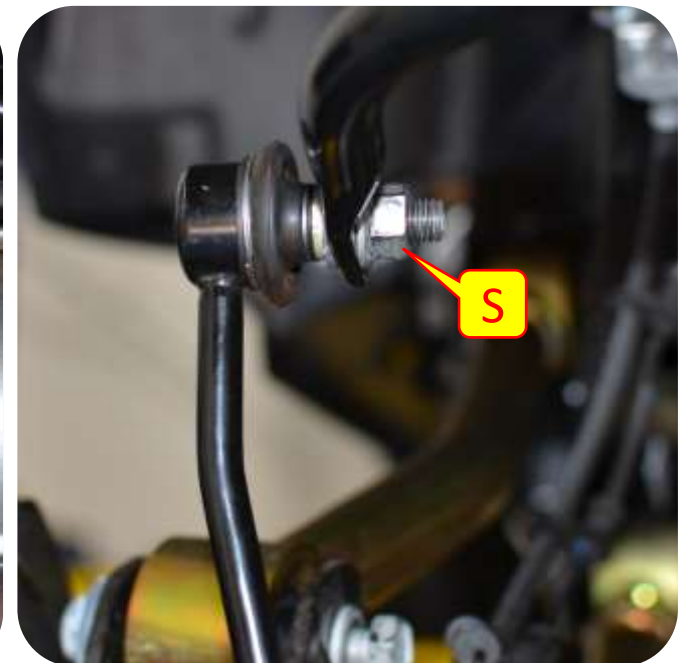
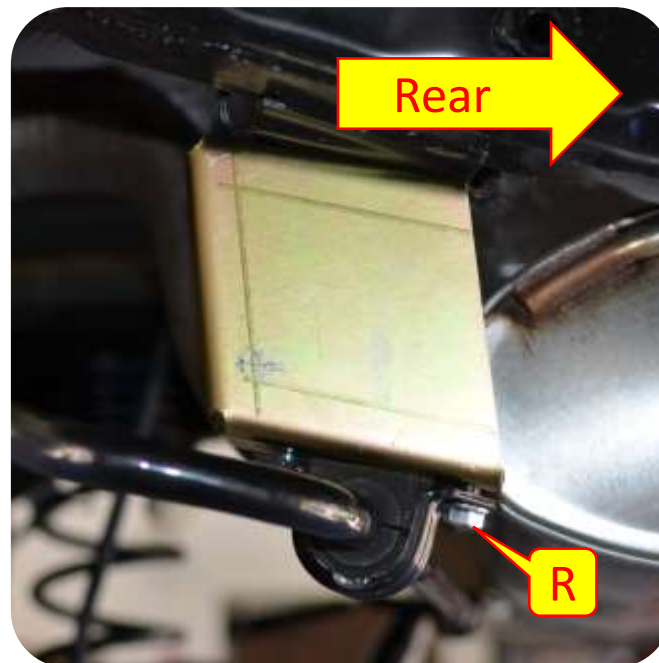

Section 3: Installation Instructions

Step 8: Sway Bar Option 2

- T. Using a 15MM socket remove the sway bar mount hardware.
- U. Install the sway bar spacer and tighten the provided hardware using a 17MM socket.
- V. Install the extended sway bar end links on the sway bar.



Section 3: Installation Instructions



Step 9: Install Rear 6Pak Shocks

- W. Align the MetalCloak rear shock relocation bracket and install the sway bar end link using a 18mm socket and wrench.
- X. Using a drill and 3/8" drill bit drill out the shock mounts upper hole
- Y. Using a 9/16" socket and wrench install the shock mount upper bolt. You must go from behind and underneath the stock shock mount to reach the hole with the nut and wrench.
- Z. Install the rear shocks.

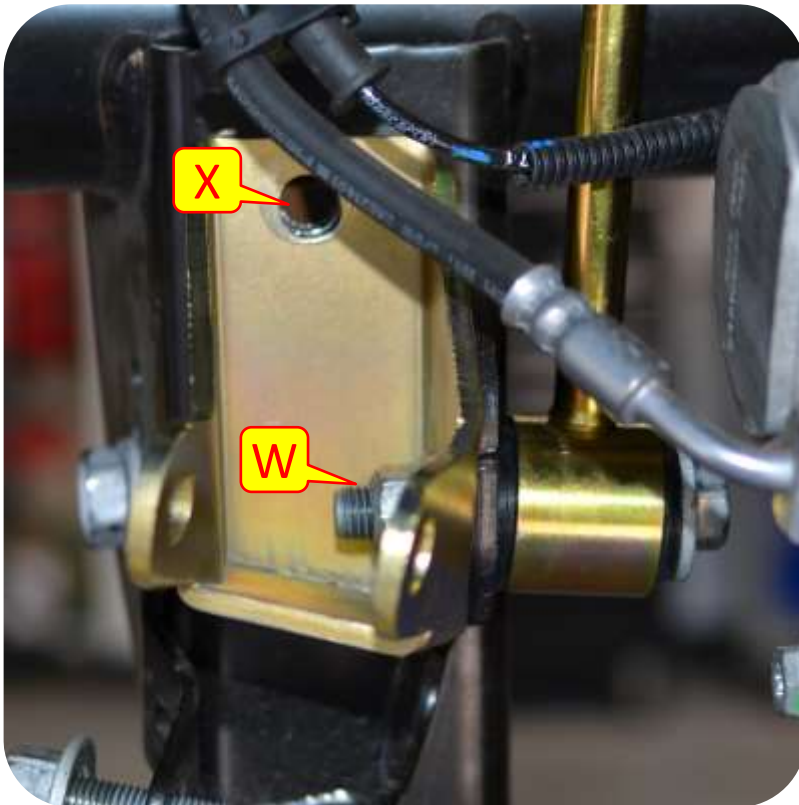

Section 3: Installation Instructions

Step 10: Install Rear Bump Stops

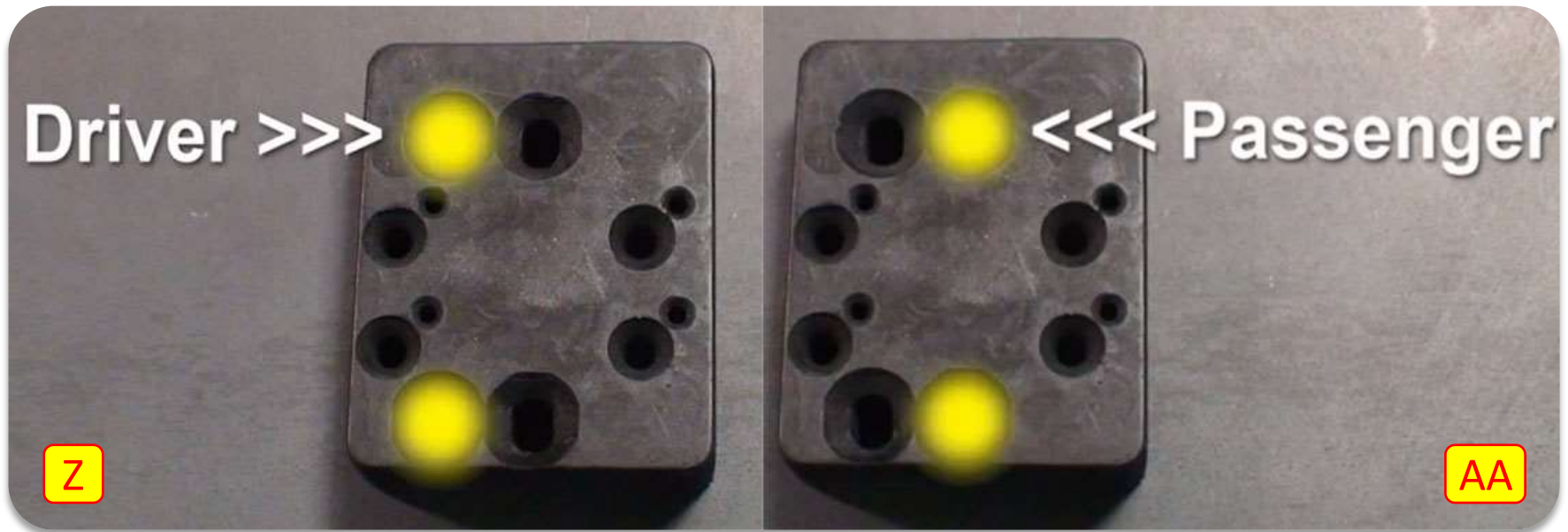

- Z. Driver Side Bump Stop Holes.
- AA. Passenger Side Bump Stop Holes.
- BB. Diagram showing the two sides of the Bump Stops.

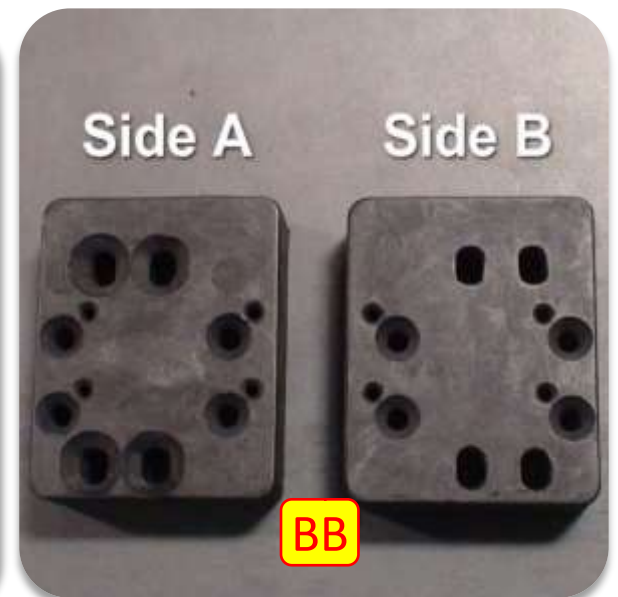

Section 3: Installation Instructions

Step 10: Install Rear Bump Stops

- CC. Install first bump stop puck (Side A) using the correct holes (shown in step A and B) using the 5/16 bolt with the matching nut and washer.
- DD. Install next puck (Side B) using the 1 3/4" woodscrews.
- EE. Continue until desired bump stop height (Side A/Side B/ Side A/Side B).



Step 11: Re-route E Brake

- FF. Disconnect the E brake cables from the brake backing plate.
- GG. Disconnect the E brake cables from the cable bracket.

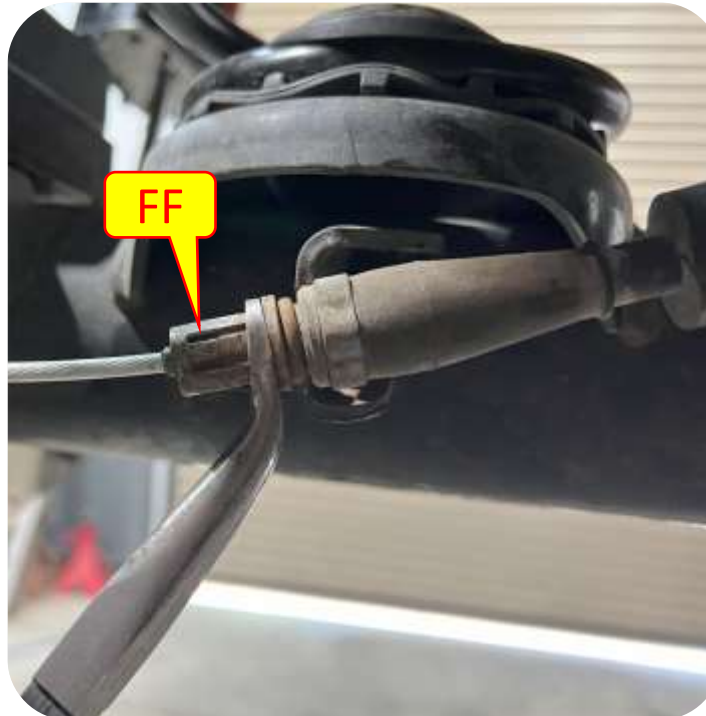

Section 3: Installation Instructions

Step 11: Re-route E Brake

- HH. Re-route the E brake cables under the crossmember.
- II. Reconnect the E Brake cable to the cable bracket
- JJ. Reconnect the E Brake cable from the brake backing plate.

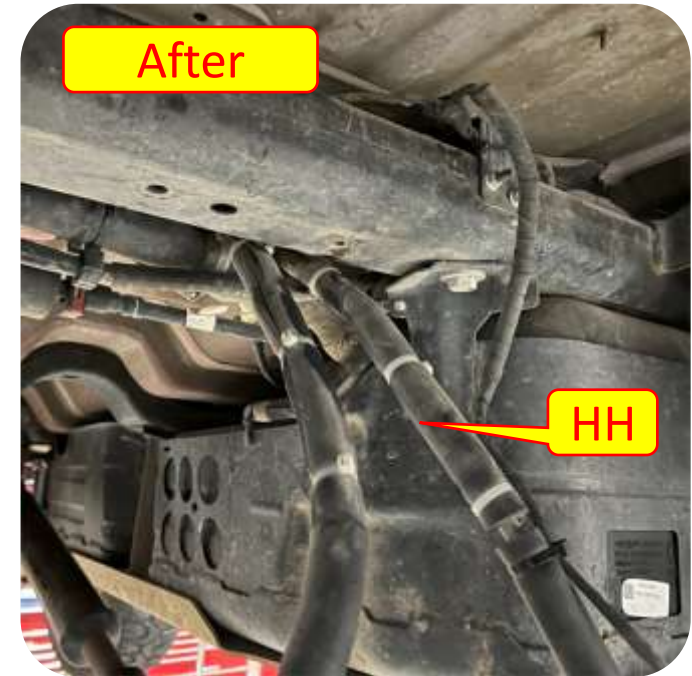

Step 12: Finalize

Important Note: After re-installing the rear brake line bracket. Bend the brake line bracket in the rear upwards towards the frame to allow slack for extra droop.

- KK. Adjust the caster angle and toe as needed. Once set, tighten all hardware, Re attach all brake line brackets. Finally, tighten the jam nuts on all control arms.



Section 3: Installation Instructions



Step 13: Modifying the UnderCloak Gas Tank Skid

The Following Step is ONLY if you have the MetalCloak UnderCloak System that needs to be modified.

To modify your UnderCloak Gas Tank Skid Plate measure 1.5" up from the bend line to the cut out for factory arms. from this point measure forward 19" in parallels to the bend line (dash line) and then up to the edge of the skid at a 135 deg angle. measure forward 14.25" and draw a circle approximately 1.5" diameter this is to clear the hardware on the long arm mount. Using a cutoff wheel cut along the line (green line). These Measurements are starting points you may need to modify your skid slightly to fit properly.

